

# PRELIMINARY STORMWATER MANAGEMENT PLAN

for

## STANDING STONE DEVELOPMENT

Tenny Avenue (extended) and Les Paul Parkway  
City of Waukesha, Wisconsin

Prepared for:

### Cornerstone Development of S.E. WI

N63 W23849 Main Street  
Sussex, WI 53089

Prepared by:

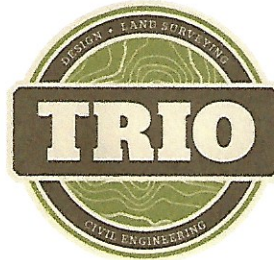

#### Trio Engineering LLC

4100 N. Calhoun Road  
Brookfield, Wisconsin 53005  
Contact: Josh Pudelko, P.E.  
Telephone: (262) 790-1480  
Email: info@trioeng.com

#### Sound Stormwater Design LLC

Contact: Jayme Sisel, P.E.  
Telephone: (414) 286-4739  
Email: jayme.sisel@soundstormwater.com



November 12, 2020

# TABLE OF CONTENTS

INTRODUCTION .....	1
DESIGN REQUIREMENTS.....	1
City of Waukesha .....	1
ANALYSIS OVERVIEW .....	1
PRE-DEVELOPMENT CONDITIONS .....	2
POST-DEVELOPMENT CONDITIONS.....	2
DETENTION SYSTEM ROUTING .....	3
PEAK DISCHARGE SUMMARIES.....	6
STORMWATER QUALITY .....	6
INFILTRATION .....	7

## APPENDICES

### FIGURES

APPENDIX A	Pre-Development Hydrologic Analysis
APPENDIX B	Post-Development Hydrologic Analysis
APPENDIX C	WinSLAMM Treatment Analysis
APPENDIX D	WinSLAMM Infiltration Analysis
APPENDIX E	NRCS Soil Survey

# Standing Stone Development Preliminary Stormwater Management Plan

## INTRODUCTION

Cornerstone Development of S.E. WI is proposing to construct a new residential development on a parcel located near the northwest corner of Tenny Avenue (extended) and Les Paul Parkway, in the City of Waukesha, Wisconsin. The proposed development also includes plans for a future multifamily development expansion on the north end of the site. Several stormwater management ponds, rain gardens and an infiltration basin will be constructed as part of the development plan to treat and manage stormwater runoff from the site. The proposed development, including future buildout, will result in a net increase in impervious area of approximately 21.52 acres.

The purpose of this report is to document design computations for existing and proposed stormwater management facilities for this area, and to present a plan for stormwater management that meets the requirements of the City of Waukesha and the Wisconsin Department of Natural Resources (WDNR).

## DESIGN REQUIREMENTS

### City of Waukesha

Chapter 32 of the City of Waukesha's Code of Ordinance includes criteria for peak discharge, water quality, and infiltration practices.

- The Ordinance requires post-development peak discharge rates to be no greater than pre-development discharge rates for the 1, 2, 10 and 100-year, 24-hour design storms.
- The Ordinance requires best management practices (BMPs) to be designed to control total suspended solids (TSS) carried by runoff from redevelopment sites by 40 percent and from new development sites by 80 percent, based on an average annual rainfall, as compared to no runoff management controls.
- The Ordinance requires medium density residential developments to infiltrate sufficient runoff volume so that the post-development infiltration volume is at least 75 percent of pre-development infiltration volume, based on an average annual rainfall. However, no more than 2 percent of the post-construction site is required as an effective infiltration area.

## ANALYSIS OVERVIEW

Peak runoff rates and volumes were computed using NRCS's TR-55 and TR-20 methodologies, as implemented by HydroCAD Version 10.00 software by HydroCAD Software Solutions.

Soil types for the site were determined from NRCS Soil Survey for Waukesha County. Soils at the site were identified as mostly Fox silt loam and Casco loam with some limited areas of Hochheim loam and Matherton silt loam soils. Based on this, a hydrologic soil group B was used to determine runoff curve numbers for the site.

MSE3 rainfall distributions were used for peak flow calculations. Rainfall values for the hydrological analysis were taken from the National Oceanic and Atmospheric Administration (NOAA) Atlas 14 Precipitation Frequency Tables for Wisconsin Counties and are shown in the following table.

**TABLE 1  
Design Rainfall Values**

Storm Recurrence Interval	24-hour Rainfall Volume
1-year	2.4 inches
2-year	2.7 inches
10-year	3.81 inches
100-year	6.18 inches

## PRE-DEVELOPMENT CONDITIONS

The project site was previously occupied by agricultural fields. Surface drainage for the site is generally from north to south towards Pebble Brook located just south of the project site. Pebble Brook is a tributary to the Fox River.

The location of the project site, land cover types, drainage subareas and flow paths are shown on Figure 1, Pre-Development Conditions Plan. The following table presents the results of the hydrological analysis for pre-development conditions. A schematic plan of the hydrological analysis and detailed hydrological computations for pre-development conditions are included in Appendix A.

**TABLE 2  
Pre-Development Site Conditions**

Subarea or Junction	Description	Area (ac)	Impervious Area (ac)	Time of Cons.	Peak Flow Rate (cfs)			
					1-year	2-year	10-year	100-year
10	Subarea (drains to existing basin)	14.99	0.00	36 min.	3.40	5.05	12.79	33.98
20	Subarea	42.38	0.20	23 min.	12.49	18.73	47.95	126.69
<b>99</b>	<b>Total Flow</b>	<b>57.37</b>	<b>0.20</b>	-	<b>14.88</b>	<b>22.37</b>	<b>57.40</b>	<b>153.11</b>

## POST-DEVELOPMENT CONDITIONS

The proposed development includes the construction of a new residential subdivision including new roadways, a clubhouse and pool, walking paths, and stormwater management ponds and an infiltration basin. The development plan also includes a future multifamily development on the north end of the site. The proposed development plan, including future buildout conditions, will disturb approximately 57 acres and will result in a net increase in impervious area of approximately 21.52 acres.

Refer to Figure 2 for drainage subareas, travel paths, and land cover types for post-development conditions. The hydrological analysis of post-development conditions was performed using the same methodology as used for pre-development conditions. The following table summarizes the results of the analysis of post-development conditions for the site.

Appendix B contains a schematic plan of the hydrological analysis and detailed hydrological computations for post-development conditions.

**TABLE 3**  
**Post-Development Site Conditions**

Subarea or Junction	Description	Area (ac)	Impervious Area (ac)	Time of Cons.	Peak Flow Rate (cfs)			
					1-year	2-year	10-year	100-year
10	Subarea (Future Dev.)	5.43	2.13	33 min.	2.62	3.49	7.15	16.17
10P	Pond	-	-	-	0.24	0.43	2.36	5.20
20	Subarea	6.86	2.69	10 min.	6.67	8.72	17.14	37.29
20P	Pond	-	-	-	0.18	0.46	3.55	9.70
30	Subarea	17.03	7.78	26 min.	12.18	15.68	29.97	63.90
30P	Pond	-	-	-	0.78	1.87	15.54	58.23
40	Subarea	3.98	2.01	9 min.	5.48	6.89	12.51	25.36
40P	Pond	-	-	-	0.26	0.29	0.38	2.51
45	Subarea	2.40	0.42	9 min.	0.84	1.34	3.68	10.20
45B	Infiltration Basin	-	-	-	0.37	0.97	7.06	22.39
50	Subarea (Undetained)	3.63	0.78	6 min.	1.97	2.94	7.21	18.42
60	Subarea (Undetained – drains to existing basin)	2.33	0.39	9 min.	0.81	1.30	3.54	9.79
65L	Link	-	-	-	2.69	4.13	10.61	27.94
70	Subarea	2.69	0.49	23 min.	0.70	1.07	2.86	7.76
70B	Dry Basin	-	-	-	0.19	0.23	0.37	1.00
80	Subarea	9.66	4.11	29 min.	5.45	7.18	14.35	31.77
80P	Pond	-	-	-	0.90	2.47	11.32	27.36
90	Subarea	1.27	0.36	6 min.	0.89	1.25	2.85	6.94
90B	Rain Garden	-	-	-	0.24	0.33	0.66	3.47
100	Subarea	2.12	0.56	10 min.	1.22	1.74	4.03	9.98
100B	Rani Garden	-	-	-	0.30	0.40	1.22	4.23
105L	Link	-	-	-	1.16	3.07	12.97	33.35
<b>110L</b>	<b>Total Flow</b>	<b>57.37</b>	<b>21.72</b>	<b>-</b>	<b>2.79</b>	<b>4.48</b>	<b>14.90</b>	<b>51.18</b>

## DETENTION SYSTEM ROUTING

The stormwater management ponds, rain gardens, and infiltration basin are designed in accordance with WDNR's Technical Standard 1001 (Wet Detention Basin), 1009 (Rain Garden) and 1003 (Infiltration Basin), respectively. Details of the outlet control structures for each

system are identified on below. The following table summarizes the routing analysis for each stormwater management system.

**TABLE 4  
Detention System Routing Analysis Summary**

**Pond 10P (Future Pond)**

System Details:

Bottom Elevation = 85.00  
Normal Water Level Elevation = 90.00  
Top of Berm Elevation = 95.00

Outlet Control:

3- inch diameter orifice at I.E. 90.00  
11-inch diameter orifice at I.E. 91.25  
10-spillway at Elevation 94.00

	1-Year Storm	2-Year Storm	10-Year Storm	100-Year Storm
Peak Inflow	2.62 cfs	3.49 cfs	7.15 cfs	16.17 cfs
Peak Outflow	0.24 cfs	0.43 cfs	2.36 cfs	5.20 cfs
Max Water Surface Elev.	91.16	91.45	92.11	93.93
Maximum Storage Volume	0.17 ac-ft	0.21 ac-ft	0.33 ac-ft	0.71 ac-ft

**Pond 20P**

System Details:

Bottom Elevation = 54.00  
Normal Water Level Elevation = 62.00  
Top of Berm Elevation = 65.00

Outlet Control:

3- inch diameter orifice at I.E. 62.00  
18-inch standpipe, rim Elevation 62.75  
10-foot spillway at Elevation 64.00

	1-Year Storm	2-Year Storm	10-Year Storm	100-Year Storm
Peak Inflow	6.67 cfs	8.72 cfs	17.14 cfs	37.29 cfs
Peak Outflow	0.18 cfs	0.46 cfs	3.55 cfs	9.70 cfs
Max Water Surface Elev.	62.70	62.82	63.11	63.96
Maximum Storage Volume	0.26 ac-ft	0.32 ac-ft	0.46 ac-ft	0.93 ac-ft

**Pond 30P**

System Details:

Bottom Elevation = 47.00  
Normal Water Level Elevation = 53.00  
Top of Berm Elevation = 58.00

Outlet Control:

3- inch diameter orifice at I.E. 53.00  
10-foot spillway at Elevation 55.00  
10-foot spillway at Elevation 57.00

	1-Year Storm	2-Year Storm	10-Year Storm	100-Year Storm
Peak Inflow	12.39 cfs	15.94 cfs	32.92 cfs	75.54 cfs
Peak Outflow	0.78 cfs	1.87 cfs	15.54 cfs	58.23 cfs
Max Water Surface Elev.	55.07	55.16	55.68	56.87
Maximum Storage Volume	0.97 ac-ft	1.02 ac-ft	1.32 ac-ft	2.08 ac-ft

**Pond 40P**

System Details:

Bottom Elevation = 50.00  
Normal Water Level Elevation = 58.60  
Top of Berm Elevation = 60.00

Outlet Control:

3- inch diameter orifice at I.E. 55.00  
10-foot spillway at Elevation 58.60

	1-Year Storm	2-Year Storm	10-Year Storm	100-Year Storm
Peak Inflow	5.48 cfs	6.90 cfs	12.60 cfs	25.63 cfs
Peak Outflow	0.26 cfs	0.29 cfs	0.38 cfs	2.51 cfs
Max Water Surface Elev.	56.30	56.62	57.73	58.80
Maximum Storage Volume	0.21 ac-ft	0.28 ac-ft	0.57 ac-ft	0.94 ac-ft

**TABLE 4**  
**Detention System Routing Analysis Summary**

<b><u>Infiltration Basin 45B</u></b>				
System Details:		Outlet Control:		
Bottom Elevation = 52.00		0.13 in/hr infiltration rate (per WDNR TS 1002)		
Top of Berm Elevation = 58.00		3-inch diameter orifice at I.E. 52.25		
		24-inch diameter orifice at I.E. 53.75		
		10-foot spillway at Elevation 57.00		
	1-Year Storm	2-Year Storm	10-Year Storm	100-Year Storm
Peak Inflow	1.06 cfs	2.24 cfs	16.40 cfs	60.71 cfs
Peak Outflow	0.37 cfs	0.97 cfs	7.06 cfs	22.39 cfs
Max Water Surface Elev.	53.80	54.06	54.88	56.82
Maximum Storage Volume	0.67 ac-ft	0.78 ac-ft	1.18 ac-ft	2.29 ac-ft
<b><u>Dry Basin 70B</u></b>				
System Details:		Outlet Control:		
Bottom Elevation = 63.50		4-inch diameter orifice at I.E. 63.50		
Top of Berm Elevation = 67.00		12-inch diameter inlet grate rim elev. 65.50		
		10-foot spillway at Elevation 66.00		
	1-Year Storm	2-Year Storm	10-Year Storm	100-Year Storm
Peak Inflow	0.70 cfs	1.07 cfs	2.86 cfs	7.76 cfs
Peak Outflow	0.19 cfs	0.23 cfs	0.37 cfs	1.00 cfs
Max Water Surface Elev.	63.87	63.98	64.45	65.62
Maximum Storage Volume	0.03 ac-ft	0.04 ac-ft	0.12 ac-ft	0.35 ac-ft
<b><u>Pond 80P</u></b>				
Pond Details:		Outlet Control:		
Bottom Elevation = 50.50		4-inch diameter underdrain at I.E. 55.50		
Normal Water Level Elevation = 55.50		30-inch diameter inlet grate at rim elev. 57.33		
Top of Berm Elevation = 59.75		10-foot spillway at Elevation 58.75		
	1-Year Storm	2-Year Storm	10-Year Storm	100-Year Storm
Peak Inflow	5.45 cfs	7.18 cfs	14.35 cfs	31.77 cfs
Peak Outflow	0.90 cfs	2.47 cfs	11.32 cfs	27.36 cfs
Max Water Surface Elev.	57.39	57.51	57.89	58.60
Maximum Storage Volume	0.29 ac-ft	0.31 ac-ft	0.39 ac-ft	0.54 ac-ft
<b><u>Rain Garden 90B</u></b>				
System Details:		Outlet Control:		
Bottom Elevation = 58.50		0.13 in/hr infiltration rate (per WDNR TS 1002)		
Top of Soil Elevation = 60.00		4-inch diameter underdrain at I.E. 58.75		
Top of Berm Elevation = 61.90		12-inch standpipe, rim Elevation 60.25		
		10-foot spillway at Elevation 60.90		
	1-Year Storm	2-Year Storm	10-Year Storm	100-Year Storm
Peak Inflow	0.89 cfs	1.25 cfs	2.85 cfs	6.94 cfs
Peak Outflow	0.24 cfs	0.33 cfs	0.66 cfs	3.47 cfs
Max Water Surface Elev.	59.22	59.51	60.31	60.83
Maximum Storage Volume	0.01 ac-ft	0.02 ac-ft	0.05 ac-ft	0.09 ac-ft

**TABLE 4  
Detention System Routing Analysis Summary**

<b>Rain Garden 100B</b>				
System Details:		Outlet Control:		
Bottom Elevation = 53.50		0.13 in/hr infiltration rate (per WDNR TS 1002)		
Top of Soil Elevation = 55.00		4-inch diameter underdrain at I.E. 53.75		
Top of Berm Elevation = 57.50		12-inch standpipe, rim Elevation 55.25		
		10-foot spillway at Elevation 56.50		
	1-Year Storm	2-Year Storm	10-Year Storm	100-Year Storm
Peak Inflow	1.22 cfs	1.74 cfs	4.03 cfs	9.98 cfs
Peak Outflow	0.30 cfs	0.40 cfs	1.22 cfs	4.23 cfs
Max Water Surface Elev.	54.39	54.78	55.42	56.14
Maximum Storage Volume	0.02 ac-ft	0.03 ac-ft	0.08 ac-ft	0.17 ac-ft

**PEAK DISCHARGE SUMMARIES**

The stormwater management system will maintain post-development peak discharge rates to be no greater than pre-development discharge rates for the 1, 2, 10 and 100-year, 24-hour design storms. This is in accordance with Waukesha’s City Ordinance. The follow table compares the results of the analyses from a peak discharge standpoint.

**TABLE 5  
Comparison of Peak Discharge**

1-yr Pre-Development		1-yr Post-Development
14.88 cfs	>	2.79 cfs
2-yr Pre-Development		2-yr Post-Development
22.37 cfs	>	4.48 cfs
10-yr Pre-Development		10-yr Post-Development
57.40 cfs	>	14.90 cfs
100-yr Pre-Development		100-yr Post-Development
153.11 cfs	>	51.18 cfs

**STORMWATER QUALITY**

The City of Waukesha’s Ordinance requires new development sites to be designed to remove 80 percent of TSS, based on an average annual rainfall as compared to no runoff management controls. Stormwater quality was analyzed using WinSLAMM Version 10.4.1 software, developed by Robert Pitt and John Voorhees. The results of the WinSLAMM analysis indicate that approximately 80 percent of TSS will be removed from stormwater as a result of the stormwater management ponds, rain gardens, infiltration basin, and two (2) sumped catch basins near the intersection of Tenny Avenue and Les Paul Parkway. Detailed computations are provided in Appendix C.



## **INFILTRATION**

The City of Waukesha's Ordinance requires medium density residential developments to infiltrate sufficient runoff volume so that the post-development infiltration volume is at least 75 percent of pre-development infiltration volume, based on an average annual rainfall. However, no more than 2 percent of the post-construction site is required as an effective infiltration area.

The infiltration analysis was performed using WinSLAMM. The results of the WinSLAMM analysis indicate that post-development conditions will infiltrate approximately 78 percent of the pre-development infiltration volume. Detailed computations are provided in Appendix D.

# FIGURES

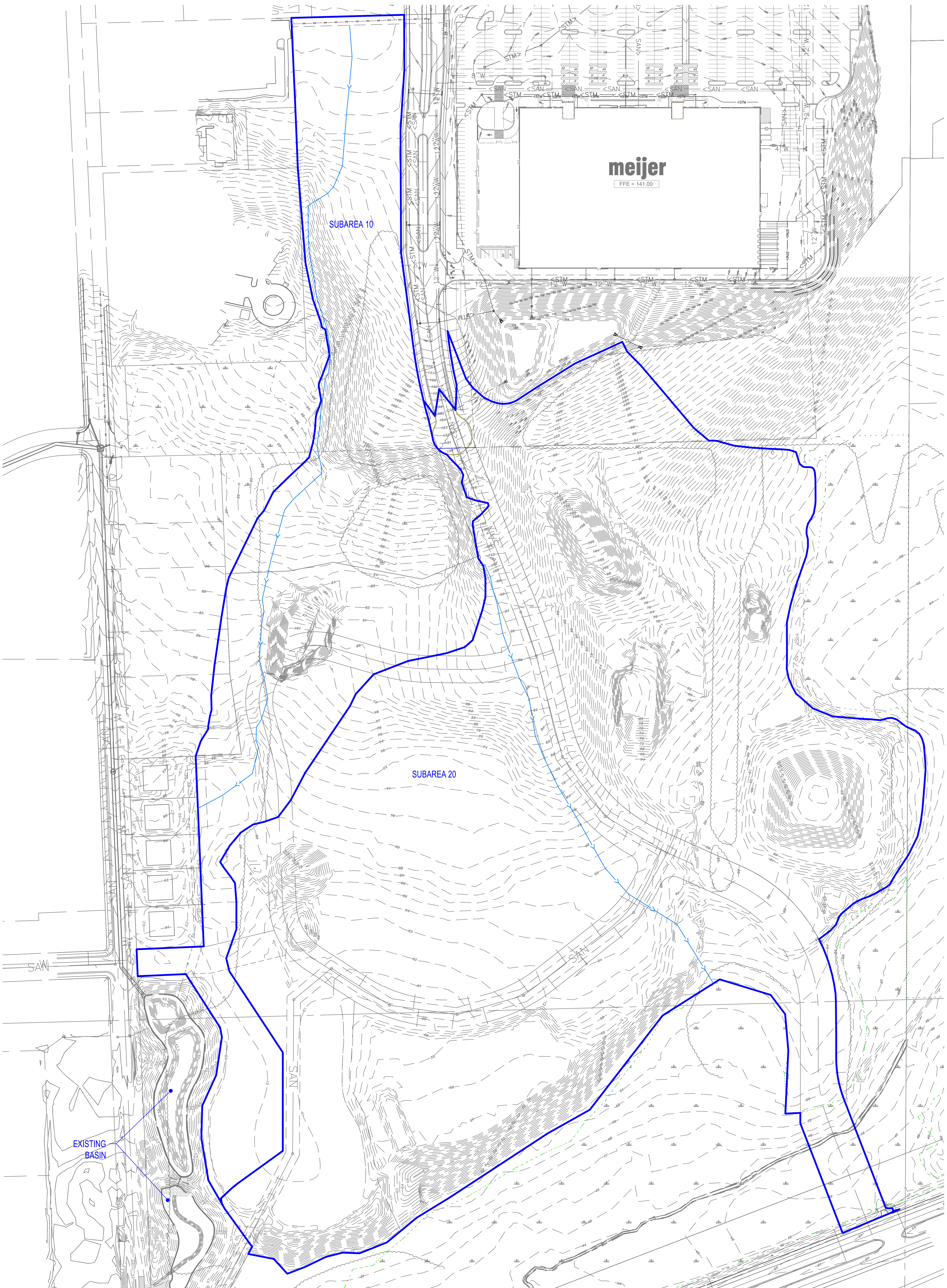

# PRE-DEVELOPMENT CONDITIONS

STANDING STONE  
DEVELOPMENT  
WAUKESHA, WISCONSIN

## LEGEND

- -DRAINAGE BASIN BOUNDARY
- > -Tc LINE

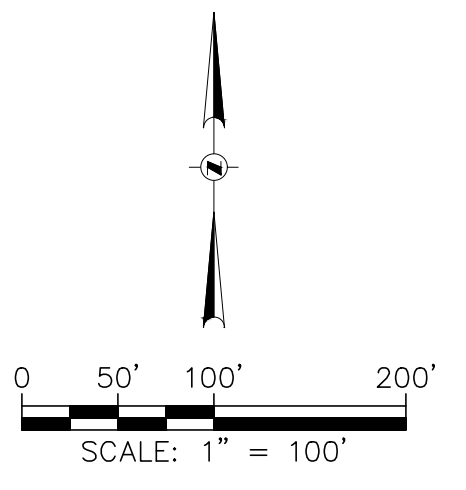

FIGURE 1



**LEGEND**

- GRASS
- ASSUMED 30% GRASS  
(ACCOUNTS FOR SIDEWALK AND DRIVES)
- WATER
- DRAINAGE BASIN BOUNDARY
- Tc LINE

# POST-DEVELOPMENT CONDITIONS

STANDING STONE  
DEVELOPMENT  
WAUKESHA, WISCONSIN

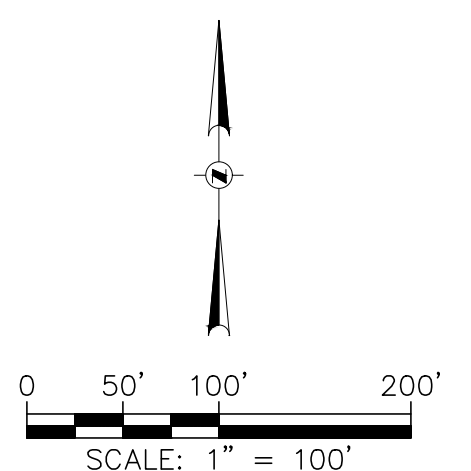

**FIGURE 2**

# APPENDIX A

Pre-Development Hydrologic Analysis

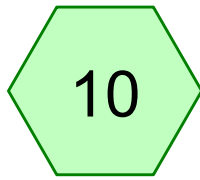

Subarea

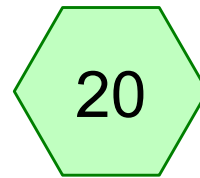

Subarea



Pre-Development  
Outflow

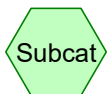

Subcat



Reach

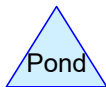

Pond



Link

## Existing\_EAST\_2020-012

Prepared by HP Inc.

HydroCAD® 10.00-25 s/n 11025 © 2019 HydroCAD Software Solutions LLC

Printed 11/11/2020

Page 2

### Area Listing (all nodes)

Area (acres)	CN	Description (subcatchment-numbers)
57.170	69	cropland - B soils (10, 20)
0.200	98	impervious (20)
<b>57.370</b>	<b>69</b>	<b>TOTAL AREA</b>

**Existing\_EAST\_2020-012**

Prepared by HP Inc.

HydroCAD® 10.00-25 s/n 11025 © 2019 HydroCAD Software Solutions LLC

MSE 24-hr 3 1 yr Rainfall=2.40"

Printed 11/11/2020

Page 3

Time span=0.00-20.00 hrs, dt=0.05 hrs, 401 points  
Runoff by SCS TR-20 method, UH=SCS, Weighted-CN  
Reach routing by Stor-Ind+Trans method - Pond routing by Stor-Ind method

**Subcatchment10: Subarea**

Runoff Area=14.990 ac 0.00% Impervious Runoff Depth>0.34"  
Flow Length=1,910' Tc=36.2 min CN=69 Runoff=3.40 cfs 0.428 af

**Subcatchment20: Subarea**

Runoff Area=42.380 ac 0.47% Impervious Runoff Depth>0.35"  
Flow Length=1,100' Slope=0.0500 '/' Tc=22.5 min CN=69 Runoff=12.49 cfs 1.220 af

**Link 99: Pre-DevelopmentOutflow**

Inflow=14.88 cfs 1.648 af  
Primary=14.88 cfs 1.648 af

**Total Runoff Area = 57.370 ac Runoff Volume = 1.648 af Average Runoff Depth = 0.34"**  
**99.65% Pervious = 57.170 ac 0.35% Impervious = 0.200 ac**



**Existing\_EAST\_2020-012**

Prepared by HP Inc.

HydroCAD® 10.00-25 s/n 11025 © 2019 HydroCAD Software Solutions LLC

*MSE 24-hr 3 2 yr Rainfall=2.70"*

Printed 11/11/2020

Page 7

Time span=0.00-20.00 hrs, dt=0.05 hrs, 401 points  
Runoff by SCS TR-20 method, UH=SCS, Weighted-CN  
Reach routing by Stor-Ind+Trans method - Pond routing by Stor-Ind method

**Subcatchment10: Subarea**

Runoff Area=14.990 ac 0.00% Impervious Runoff Depth>0.47"  
Flow Length=1,910' Tc=36.2 min CN=69 Runoff=5.05 cfs 0.592 af

**Subcatchment20: Subarea**

Runoff Area=42.380 ac 0.47% Impervious Runoff Depth>0.48"  
Flow Length=1,100' Slope=0.0500 '/' Tc=22.5 min CN=69 Runoff=18.73 cfs 1.684 af

**Link 99: Pre-DevelopmentOutflow**

Inflow=22.37 cfs 2.276 af  
Primary=22.37 cfs 2.276 af

**Total Runoff Area = 57.370 ac Runoff Volume = 2.276 af Average Runoff Depth = 0.48"**  
**99.65% Pervious = 57.170 ac 0.35% Impervious = 0.200 ac**

**Existing\_EAST\_2020-012**

MSE 24-hr 3 10 yr Rainfall=3.81"

Prepared by HP Inc.

Printed 11/11/2020

HydroCAD® 10.00-25 s/n 11025 © 2019 HydroCAD Software Solutions LLC

Page 11

Time span=0.00-20.00 hrs, dt=0.05 hrs, 401 points  
Runoff by SCS TR-20 method, UH=SCS, Weighted-CN  
Reach routing by Stor-Ind+Trans method - Pond routing by Stor-Ind method

**Subcatchment10: Subarea**

Runoff Area=14.990 ac 0.00% Impervious Runoff Depth>1.07"  
Flow Length=1,910' Tc=36.2 min CN=69 Runoff=12.79 cfs 1.335 af

**Subcatchment20: Subarea**

Runoff Area=42.380 ac 0.47% Impervious Runoff Depth>1.07"  
Flow Length=1,100' Slope=0.0500 '/' Tc=22.5 min CN=69 Runoff=47.95 cfs 3.794 af

**Link 99: Pre-DevelopmentOutflow**

Inflow=57.40 cfs 5.129 af  
Primary=57.40 cfs 5.129 af

**Total Runoff Area = 57.370 ac Runoff Volume = 5.129 af Average Runoff Depth = 1.07"**  
**99.65% Pervious = 57.170 ac 0.35% Impervious = 0.200 ac**

**Existing\_EAST\_2020-012**

MSE 24-hr 3 100 yr Rainfall=6.18"

Prepared by HP Inc.

Printed 11/11/2020

HydroCAD® 10.00-25 s/n 11025 © 2019 HydroCAD Software Solutions LLC

Page 15

Time span=0.00-20.00 hrs, dt=0.05 hrs, 401 points  
Runoff by SCS TR-20 method, UH=SCS, Weighted-CN  
Reach routing by Stor-Ind+Trans method - Pond routing by Stor-Ind method

**Subcatchment10: Subarea**

Runoff Area=14.990 ac 0.00% Impervious Runoff Depth>2.70"  
Flow Length=1,910' Tc=36.2 min CN=69 Runoff=33.98 cfs 3.371 af

**Subcatchment20: Subarea**

Runoff Area=42.380 ac 0.47% Impervious Runoff Depth>2.71"  
Flow Length=1,100' Slope=0.0500 '/' Tc=22.5 min CN=69 Runoff=126.69 cfs 9.572 af

**Link 99: Pre-DevelopmentOutflow**

Inflow=153.11 cfs 12.943 af  
Primary=153.11 cfs 12.943 af

**Total Runoff Area = 57.370 ac Runoff Volume = 12.943 af Average Runoff Depth = 2.71"**  
**99.65% Pervious = 57.170 ac 0.35% Impervious = 0.200 ac**

**Summary for Subcatchment 10: Subarea**

Runoff = 33.98 cfs @ 12.52 hrs, Volume= 3.371 af, Depth> 2.70"

Runoff by SCS TR-20 method, UH=SCS, Weighted-CN, Time Span= 0.00-20.00 hrs, dt= 0.05 hrs  
 MSE 24-hr 3 100 yr Rainfall=6.18"

Area (ac)	CN	Description
* 14.990	69	cropland - B soils
14.990		100.00% Pervious Area

Tc (min)	Length (feet)	Slope (ft/ft)	Velocity (ft/sec)	Capacity (cfs)	Description
22.9	300	0.0200	0.22		Sheet Flow, Range n= 0.130 P2= 2.70"
13.3	1,610	0.0500	2.01		Shallow Concentrated Flow, Cultivated Straight Rows Kv= 9.0 fps
36.2	1,910	Total			

**Subcatchment 10: Subarea**

Hydrograph

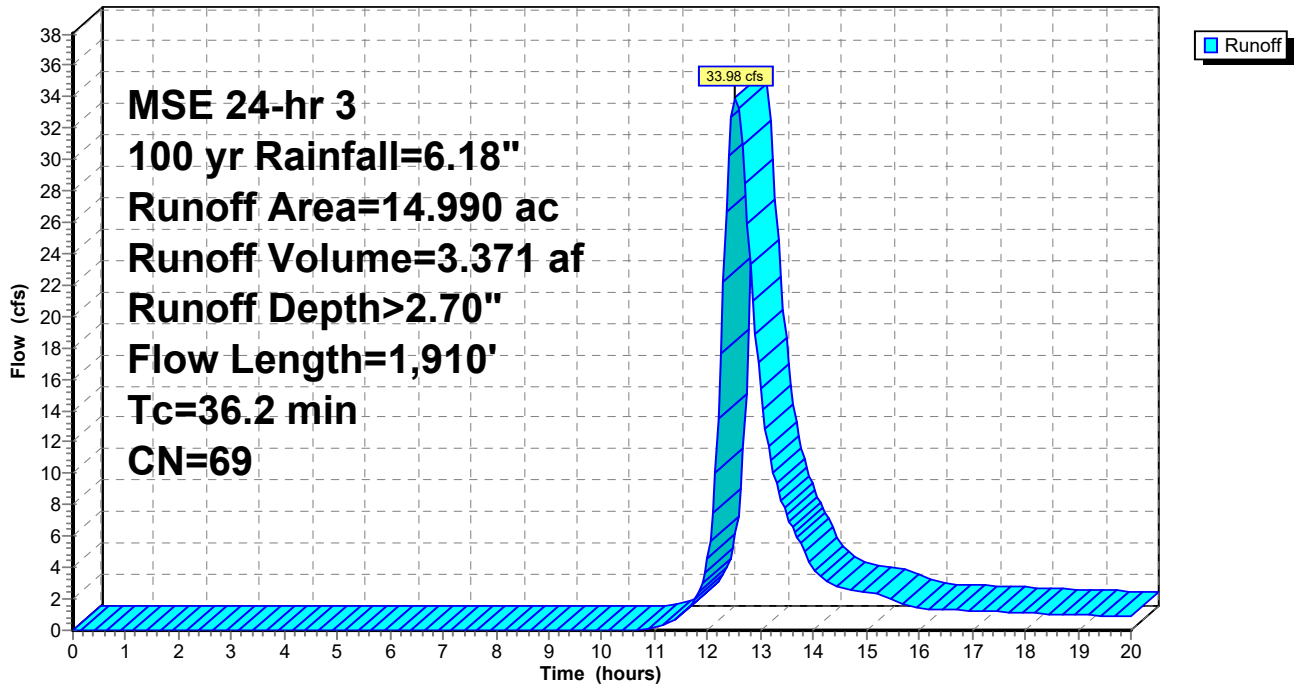

**Summary for Subcatchment 20: Subarea**

Runoff = 126.69 cfs @ 12.34 hrs, Volume= 9.572 af, Depth> 2.71"

Runoff by SCS TR-20 method, UH=SCS, Weighted-CN, Time Span= 0.00-20.00 hrs, dt= 0.05 hrs  
 MSE 24-hr 3 100 yr Rainfall=6.18"

Area (ac)	CN	Description
* 42.180	69	cropland - B soils
* 0.200	98	impervious
42.380	69	Weighted Average
42.180		99.53% Pervious Area
0.200		0.47% Impervious Area

Tc (min)	Length (feet)	Slope (ft/ft)	Velocity (ft/sec)	Capacity (cfs)	Description
15.9	300	0.0500	0.31		<b>Sheet Flow,</b> Range n= 0.130 P2= 2.70"
6.6	800	0.0500	2.01		<b>Shallow Concentrated Flow,</b> Cultivated Straight Rows Kv= 9.0 fps
22.5	1,100	Total			

**Subcatchment 20: Subarea**

Hydrograph

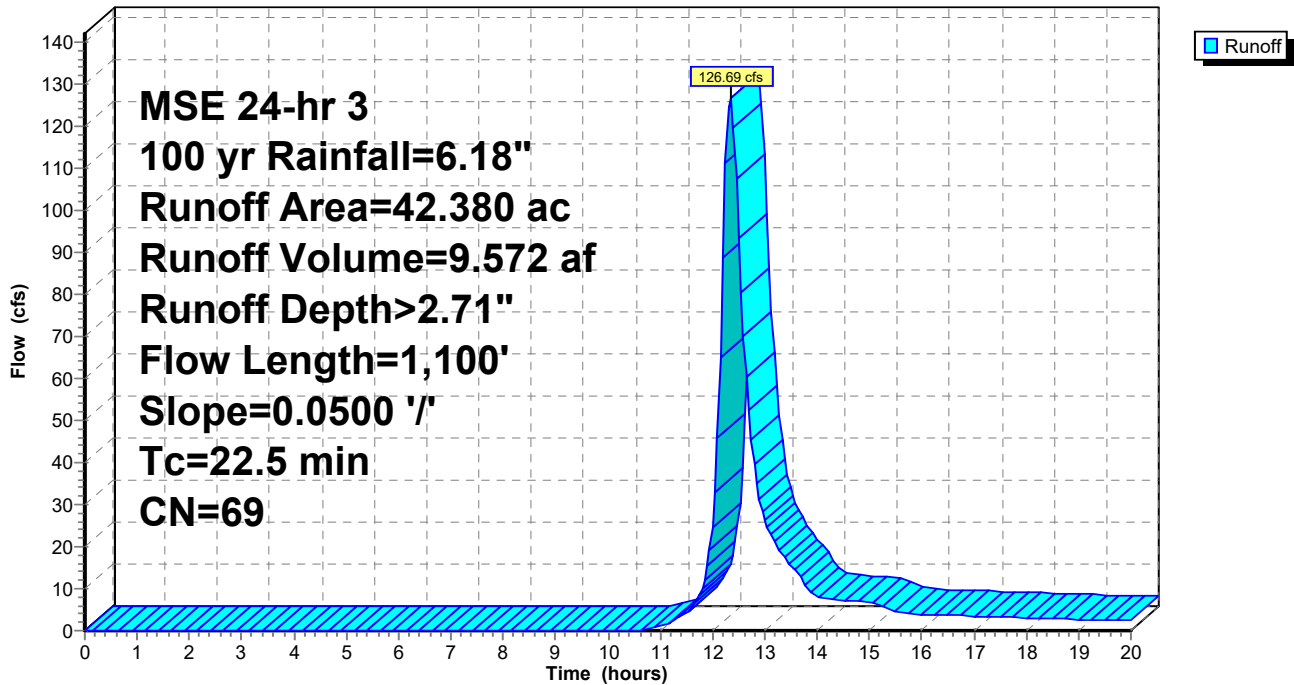

### Summary for Link 99: Pre-Development Outflow

Inflow Area = 57.370 ac, 0.35% Impervious, Inflow Depth > 2.71" for 100 yr event  
Inflow = 153.11 cfs @ 12.36 hrs, Volume= 12.943 af  
Primary = 153.11 cfs @ 12.36 hrs, Volume= 12.943 af, Atten= 0%, Lag= 0.0 min

Primary outflow = Inflow, Time Span= 0.00-20.00 hrs, dt= 0.05 hrs

### Link 99: Pre-Development Outflow

Hydrograph

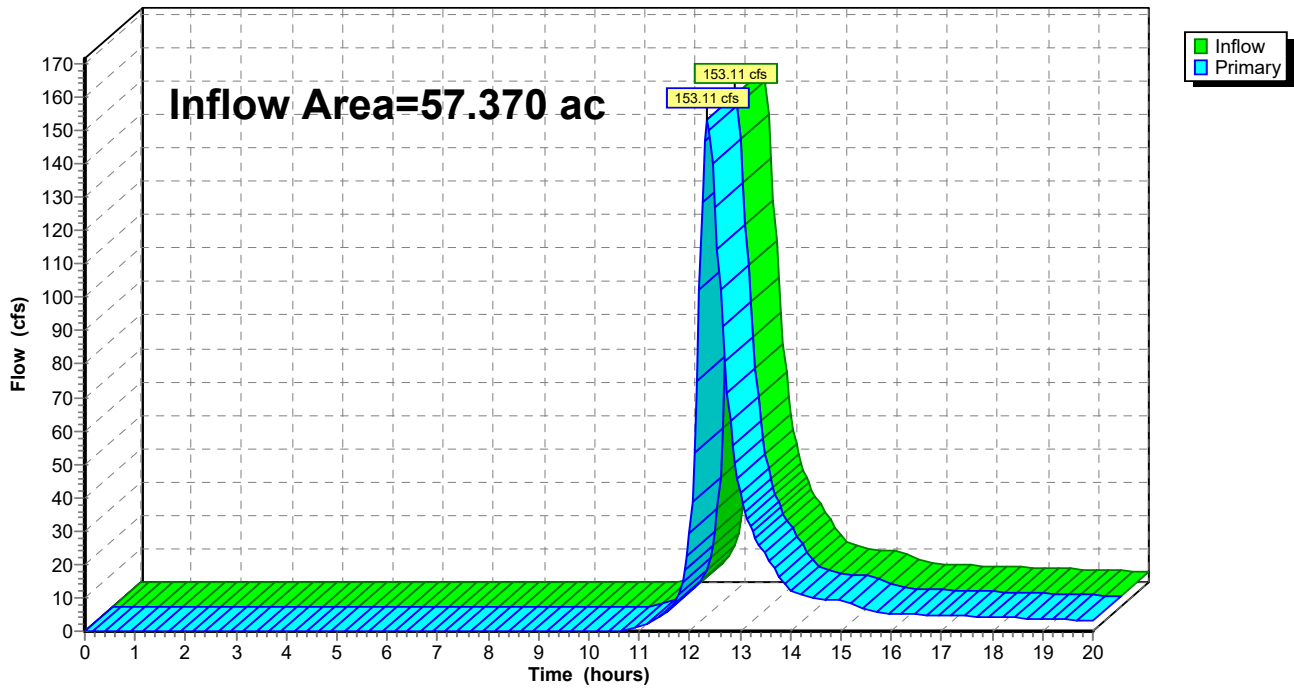

# APPENDIX B

Post-Development Hydrologic Analysis

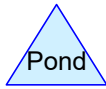
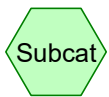
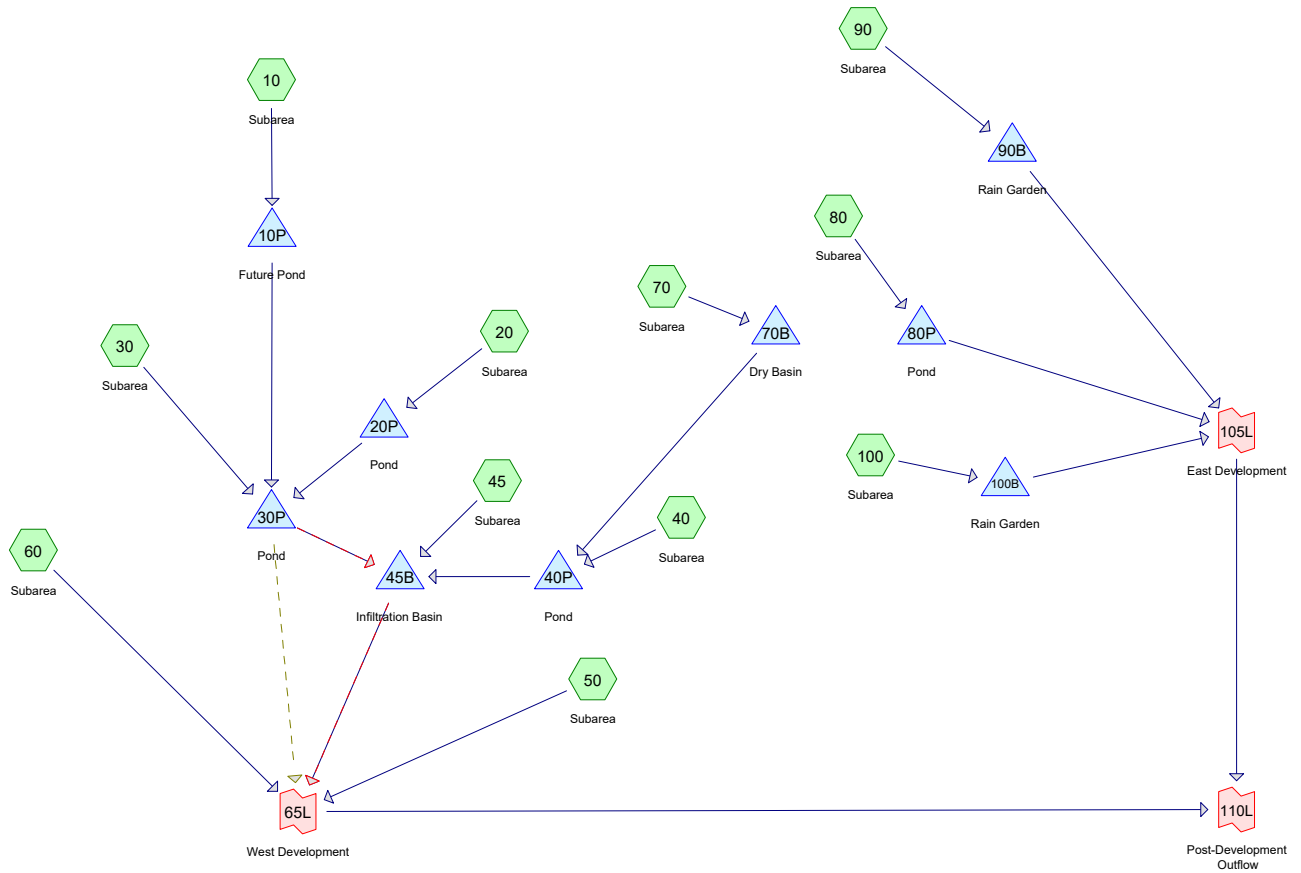

**Routing Diagram for Proposed\_EAST\_2020-012**  
 Prepared by HP Inc., Printed 11/11/2020  
 HydroCAD® 10.00-25 s/n 11025 © 2019 HydroCAD Software Solutions LLC



**Proposed\_EAST\_2020-012**

Prepared by HP Inc.

HydroCAD® 10.00-25 s/n 11025 © 2019 HydroCAD Software Solutions LLC

Printed 11/11/2020

Page 2

**Area Listing (all nodes)**

Area (acres)	CN	Description (subcatchment-numbers)
34.530	61	grass - B soils (10, 20, 30, 40, 45, 50, 60, 70, 80, 90, 100)
21.720	98	impervious (10, 20, 30, 40, 45, 50, 60, 70, 80, 90, 100)
1.120	98	water (10, 20, 30, 40, 80)
<b>57.370</b>	<b>76</b>	<b>TOTAL AREA</b>

**Proposed\_EAST\_2020-012**

Prepared by HP Inc.

HydroCAD® 10.00-25 s/n 11025 © 2019 HydroCAD Software Solutions LLC

MSE 24-hr 3 1 yr Rainfall=2.40"

Printed 11/11/2020

Page 3

Time span=0.00-48.00 hrs, dt=0.05 hrs, 961 points  
 Runoff by SCS TR-20 method, UH=SCS, Weighted-CN  
 Reach routing by Dyn-Stor-Ind method - Pond routing by Dyn-Stor-Ind method

<b>Subcatchment10: Subarea</b>	Runoff Area=5.430 ac 41.62% Impervious Runoff Depth=0.63" Flow Length=975' Tc=33.3 min CN=76 Runoff=2.62 cfs 0.287 af
<b>Subcatchment20: Subarea</b>	Runoff Area=6.860 ac 43.88% Impervious Runoff Depth=0.68" Flow Length=235' Slope=0.0400 '/' Tc=10.3 min CN=77 Runoff=6.67 cfs 0.388 af
<b>Subcatchment30: Subarea</b>	Runoff Area=17.030 ac 48.03% Impervious Runoff Depth=0.77" Flow Length=1,365' Tc=25.6 min CN=79 Runoff=12.18 cfs 1.094 af
<b>Subcatchment40: Subarea</b>	Runoff Area=3.950 ac 54.43% Impervious Runoff Depth=0.87" Flow Length=550' Tc=8.7 min CN=81 Runoff=5.48 cfs 0.287 af
<b>Subcatchment45: Subarea</b>	Runoff Area=2.400 ac 17.50% Impervious Runoff Depth=0.32" Flow Length=325' Tc=9.0 min CN=67 Runoff=0.84 cfs 0.063 af
<b>Subcatchment50: Subarea</b>	Runoff Area=3.630 ac 21.49% Impervious Runoff Depth=0.38" Flow Length=60' Tc=6.4 min CN=69 Runoff=1.97 cfs 0.114 af
<b>Subcatchment60: Subarea</b>	Runoff Area=2.330 ac 16.74% Impervious Runoff Depth=0.32" Flow Length=220' Slope=0.0400 '/' Tc=9.1 min CN=67 Runoff=0.81 cfs 0.061 af
<b>Subcatchment70: Subarea</b>	Runoff Area=2.690 ac 18.22% Impervious Runoff Depth=0.35" Flow Length=260' Tc=22.5 min CN=68 Runoff=0.70 cfs 0.077 af
<b>Subcatchment80: Subarea</b>	Runoff Area=9.660 ac 43.89% Impervious Runoff Depth=0.68" Flow Length=1,855' Tc=29.4 min CN=77 Runoff=5.45 cfs 0.546 af
<b>Subcatchment90: Subarea</b>	Runoff Area=1.270 ac 28.35% Impervious Runoff Depth=0.44" Flow Length=45' Slope=0.0500 '/' Tc=6.0 min CN=71 Runoff=0.89 cfs 0.047 af
<b>Subcatchment100: Subarea</b>	Runoff Area=2.120 ac 26.42% Impervious Runoff Depth=0.44" Flow Length=275' Tc=9.6 min CN=71 Runoff=1.22 cfs 0.078 af
<b>Pond 10P: Future Pond</b>	Peak Elev=91.16' Storage=0.166 af Inflow=2.62 cfs 0.287 af Outflow=0.24 cfs 0.283 af
<b>Pond 20P: Pond</b>	Peak Elev=62.70' Storage=0.264 af Inflow=6.67 cfs 0.388 af Outflow=0.18 cfs 0.349 af
<b>Pond 30P: Pond</b>	Peak Elev=55.07' Storage=0.971 af Inflow=12.39 cfs 1.726 af Primary=0.33 cfs 0.792 af Secondary=0.45 cfs 0.239 af Tertiary=0.00 cfs 0.000 af Outflow=0.78 cfs 1.031 af
<b>Pond 40P: Pond</b>	Peak Elev=56.30' Storage=0.211 af Inflow=5.48 cfs 0.364 af Outflow=0.26 cfs 0.358 af
<b>Pond 45B: Infiltration Basin</b>	Peak Elev=53.80' Storage=0.668 af Inflow=1.06 cfs 1.453 af Discarded=0.07 cfs 0.180 af Primary=0.30 cfs 0.701 af Outflow=0.37 cfs 0.881 af

**Proposed\_EAST\_2020-012**

Prepared by HP Inc.

HydroCAD® 10.00-25 s/n 11025 © 2019 HydroCAD Software Solutions LLC

*MSE 24-hr 3 1 yr Rainfall=2.40"*

Printed 11/11/2020

Page 4

---

<b>Pond 70B: Dry Basin</b>	Peak Elev=63.87'	Storage=0.025 af	Inflow=0.70 cfs	0.077 af	Outflow=0.19 cfs	0.077 af
<b>Pond 80P: Pond</b>	Peak Elev=57.39'	Storage=0.291 af	Inflow=5.45 cfs	0.546 af	Outflow=0.90 cfs	0.542 af
<b>Pond 90B: Rain Garden</b>	Peak Elev=59.22'	Storage=0.013 af	Inflow=0.89 cfs	0.047 af	Discarded=0.01 cfs	0.013 af
		Primary=0.23 cfs	0.034 af	Outflow=0.24 cfs	0.047 af	
<b>Pond 100B: Rain Garden</b>	Peak Elev=54.39'	Storage=0.024 af	Inflow=1.22 cfs	0.078 af	Discarded=0.01 cfs	0.020 af
		Primary=0.29 cfs	0.058 af	Outflow=0.30 cfs	0.078 af	
<b>Link 65L: West Development</b>			Inflow=2.69 cfs	0.876 af	Primary=2.69 cfs	0.876 af
<b>Link 105L: East Development</b>			Inflow=1.16 cfs	0.635 af	Primary=1.16 cfs	0.635 af
<b>Link 110L: Post-DevelopmentOutflow</b>			Inflow=2.79 cfs	1.510 af	Primary=2.79 cfs	1.510 af

**Total Runoff Area = 57.370 ac   Runoff Volume = 3.043 af   Average Runoff Depth = 0.64"**  
**60.19% Pervious = 34.530 ac   39.81% Impervious = 22.840 ac**

**Proposed EAST\_2020-012**

Prepared by HP Inc.

HydroCAD® 10.00-25 s/n 11025 © 2019 HydroCAD Software Solutions LLC

*MSE 24-hr 3 2 yr Rainfall=2.70"*

Printed 11/11/2020

Page 38

Time span=0.00-48.00 hrs, dt=0.05 hrs, 961 points  
 Runoff by SCS TR-20 method, UH=SCS, Weighted-CN  
 Reach routing by Dyn-Stor-Ind method - Pond routing by Dyn-Stor-Ind method

<b>Subcatchment10: Subarea</b>	Runoff Area=5.430 ac 41.62% Impervious Runoff Depth=0.82" Flow Length=975' Tc=33.3 min CN=76 Runoff=3.49 cfs 0.370 af
<b>Subcatchment20: Subarea</b>	Runoff Area=6.860 ac 43.88% Impervious Runoff Depth=0.87" Flow Length=235' Slope=0.0400 '/' Tc=10.3 min CN=77 Runoff=8.72 cfs 0.497 af
<b>Subcatchment30: Subarea</b>	Runoff Area=17.030 ac 48.03% Impervious Runoff Depth=0.97" Flow Length=1,365' Tc=25.6 min CN=79 Runoff=15.68 cfs 1.382 af
<b>Subcatchment40: Subarea</b>	Runoff Area=3.950 ac 54.43% Impervious Runoff Depth=1.09" Flow Length=550' Tc=8.7 min CN=81 Runoff=6.89 cfs 0.358 af
<b>Subcatchment45: Subarea</b>	Runoff Area=2.400 ac 17.50% Impervious Runoff Depth=0.44" Flow Length=325' Tc=9.0 min CN=67 Runoff=1.34 cfs 0.089 af
<b>Subcatchment50: Subarea</b>	Runoff Area=3.630 ac 21.49% Impervious Runoff Depth=0.52" Flow Length=60' Tc=6.4 min CN=69 Runoff=2.94 cfs 0.156 af
<b>Subcatchment60: Subarea</b>	Runoff Area=2.330 ac 16.74% Impervious Runoff Depth=0.44" Flow Length=220' Slope=0.0400 '/' Tc=9.1 min CN=67 Runoff=1.30 cfs 0.086 af
<b>Subcatchment70: Subarea</b>	Runoff Area=2.690 ac 18.22% Impervious Runoff Depth=0.48" Flow Length=260' Tc=22.5 min CN=68 Runoff=1.07 cfs 0.107 af
<b>Subcatchment80: Subarea</b>	Runoff Area=9.660 ac 43.89% Impervious Runoff Depth=0.87" Flow Length=1,855' Tc=29.4 min CN=77 Runoff=7.18 cfs 0.699 af
<b>Subcatchment90: Subarea</b>	Runoff Area=1.270 ac 28.35% Impervious Runoff Depth=0.59" Flow Length=45' Slope=0.0500 '/' Tc=6.0 min CN=71 Runoff=1.25 cfs 0.063 af
<b>Subcatchment100: Subarea</b>	Runoff Area=2.120 ac 26.42% Impervious Runoff Depth=0.59" Flow Length=275' Tc=9.6 min CN=71 Runoff=1.74 cfs 0.105 af
<b>Pond 10P: Future Pond</b>	Peak Elev=91.45' Storage=0.213 af Inflow=3.49 cfs 0.370 af Outflow=0.43 cfs 0.365 af
<b>Pond 20P: Pond</b>	Peak Elev=62.82' Storage=0.315 af Inflow=8.72 cfs 0.497 af Outflow=0.46 cfs 0.452 af
<b>Pond 30P: Pond</b>	Peak Elev=55.16' Storage=1.018 af Inflow=15.94 cfs 2.199 af Primary=0.34 cfs 0.752 af Secondary=1.53 cfs 0.710 af Tertiary=0.00 cfs 0.000 af Outflow=1.87 cfs 1.462 af
<b>Pond 40P: Pond</b>	Peak Elev=56.62' Storage=0.278 af Inflow=6.90 cfs 0.465 af Outflow=0.29 cfs 0.458 af
<b>Pond 45B: Infiltration Basin</b>	Peak Elev=54.06' Storage=0.784 af Inflow=2.24 cfs 2.009 af Discarded=0.07 cfs 0.192 af Primary=0.90 cfs 1.217 af Outflow=0.97 cfs 1.409 af

**Proposed\_EAST\_2020-012**

Prepared by HP Inc.

HydroCAD® 10.00-25 s/n 11025 © 2019 HydroCAD Software Solutions LLC

*MSE 24-hr 3 2 yr Rainfall=2.70"*

Printed 11/11/2020

Page 39

---

<b>Pond 70B: Dry Basin</b>	Peak Elev=63.98'	Storage=0.040 af	Inflow=1.07 cfs	0.107 af	Outflow=0.23 cfs	0.107 af
<b>Pond 80P: Pond</b>	Peak Elev=57.51'	Storage=0.313 af	Inflow=7.18 cfs	0.699 af	Outflow=2.47 cfs	0.695 af
<b>Pond 90B: Rain Garden</b>	Peak Elev=59.51'	Storage=0.018 af	Inflow=1.25 cfs	0.063 af	Discarded=0.01 cfs	0.013 af
		Primary=0.32 cfs	0.050 af	Outflow=0.33 cfs	0.063 af	
<b>Pond 100B: Rain Garden</b>	Peak Elev=54.78'	Storage=0.034 af	Inflow=1.74 cfs	0.105 af	Discarded=0.01 cfs	0.020 af
		Primary=0.39 cfs	0.085 af	Outflow=0.40 cfs	0.105 af	
<b>Link 65L: West Development</b>			Inflow=4.13 cfs	1.459 af	Primary=4.13 cfs	1.459 af
<b>Link 105L: East Development</b>			Inflow=3.07 cfs	0.830 af	Primary=3.07 cfs	0.830 af
<b>Link 110L: Post-DevelopmentOutflow</b>			Inflow=4.48 cfs	2.289 af	Primary=4.48 cfs	2.289 af

**Total Runoff Area = 57.370 ac   Runoff Volume = 3.912 af   Average Runoff Depth = 0.82"**  
**60.19% Pervious = 34.530 ac   39.81% Impervious = 22.840 ac**

**Proposed EAST\_2020-012**

MSE 24-hr 3 10 yr Rainfall=3.81"

Prepared by HP Inc.

Printed 11/11/2020

HydroCAD® 10.00-25 s/n 11025 © 2019 HydroCAD Software Solutions LLC

Page 73

Time span=0.00-48.00 hrs, dt=0.05 hrs, 961 points  
 Runoff by SCS TR-20 method, UH=SCS, Weighted-CN  
 Reach routing by Dyn-Stor-Ind method - Pond routing by Dyn-Stor-Ind method

<b>Subcatchment10: Subarea</b>	Runoff Area=5.430 ac 41.62% Impervious Runoff Depth=1.59" Flow Length=975' Tc=33.3 min CN=76 Runoff=7.15 cfs 0.721 af
<b>Subcatchment20: Subarea</b>	Runoff Area=6.860 ac 43.88% Impervious Runoff Depth=1.66" Flow Length=235' Slope=0.0400 '/' Tc=10.3 min CN=77 Runoff=17.14 cfs 0.952 af
<b>Subcatchment30: Subarea</b>	Runoff Area=17.030 ac 48.03% Impervious Runoff Depth=1.81" Flow Length=1,365' Tc=25.6 min CN=79 Runoff=29.97 cfs 2.569 af
<b>Subcatchment40: Subarea</b>	Runoff Area=3.950 ac 54.43% Impervious Runoff Depth=1.96" Flow Length=550' Tc=8.7 min CN=81 Runoff=12.51 cfs 0.646 af
<b>Subcatchment45: Subarea</b>	Runoff Area=2.400 ac 17.50% Impervious Runoff Depth=1.03" Flow Length=325' Tc=9.0 min CN=67 Runoff=3.68 cfs 0.206 af
<b>Subcatchment50: Subarea</b>	Runoff Area=3.630 ac 21.49% Impervious Runoff Depth=1.14" Flow Length=60' Tc=6.4 min CN=69 Runoff=7.21 cfs 0.346 af
<b>Subcatchment60: Subarea</b>	Runoff Area=2.330 ac 16.74% Impervious Runoff Depth=1.03" Flow Length=220' Slope=0.0400 '/' Tc=9.1 min CN=67 Runoff=3.54 cfs 0.200 af
<b>Subcatchment70: Subarea</b>	Runoff Area=2.690 ac 18.22% Impervious Runoff Depth=1.09" Flow Length=260' Tc=22.5 min CN=68 Runoff=2.86 cfs 0.244 af
<b>Subcatchment80: Subarea</b>	Runoff Area=9.660 ac 43.89% Impervious Runoff Depth=1.66" Flow Length=1,855' Tc=29.4 min CN=77 Runoff=14.35 cfs 1.340 af
<b>Subcatchment90: Subarea</b>	Runoff Area=1.270 ac 28.35% Impervious Runoff Depth=1.27" Flow Length=45' Slope=0.0500 '/' Tc=6.0 min CN=71 Runoff=2.85 cfs 0.134 af
<b>Subcatchment100: Subarea</b>	Runoff Area=2.120 ac 26.42% Impervious Runoff Depth=1.27" Flow Length=275' Tc=9.6 min CN=71 Runoff=4.03 cfs 0.224 af
<b>Pond 10P: Future Pond</b>	Peak Elev=92.11' Storage=0.328 af Inflow=7.15 cfs 0.721 af Outflow=2.36 cfs 0.716 af
<b>Pond 20P: Pond</b>	Peak Elev=63.11' Storage=0.456 af Inflow=17.14 cfs 0.952 af Outflow=3.55 cfs 0.902 af
<b>Pond 30P: Pond</b>	Peak Elev=55.68' Storage=1.316 af Inflow=32.92 cfs 4.187 af Primary=0.38 cfs 0.689 af Secondary=15.17 cfs 2.721 af Tertiary=0.00 cfs 0.000 af Outflow=15.54 cfs 3.409 af
<b>Pond 40P: Pond</b>	Peak Elev=57.73' Storage=0.572 af Inflow=12.60 cfs 0.889 af Outflow=0.38 cfs 0.855 af
<b>Pond 45B: Infiltration Basin</b>	Peak Elev=54.88' Storage=1.177 af Inflow=16.40 cfs 4.470 af Discarded=0.08 cfs 0.208 af Primary=6.98 cfs 3.589 af Outflow=7.06 cfs 3.797 af

**Proposed\_EAST\_2020-012**

Prepared by HP Inc.

HydroCAD® 10.00-25 s/n 11025 © 2019 HydroCAD Software Solutions LLC

*MSE 24-hr 3 10 yr Rainfall=3.81"*

Printed 11/11/2020

Page 74

**Pond 70B: Dry Basin**

Peak Elev=64.45' Storage=0.119 af Inflow=2.86 cfs 0.244 af  
Outflow=0.37 cfs 0.243 af

**Pond 80P: Pond**

Peak Elev=57.89' Storage=0.389 af Inflow=14.35 cfs 1.340 af  
Outflow=11.32 cfs 1.336 af

**Pond 90B: Rain Garden**

Peak Elev=60.31' Storage=0.048 af Inflow=2.85 cfs 0.134 af  
Discarded=0.01 cfs 0.014 af Primary=0.65 cfs 0.120 af Outflow=0.66 cfs 0.134 af

**Pond 100B: Rain Garden**

Peak Elev=55.42' Storage=0.081 af Inflow=4.03 cfs 0.224 af  
Discarded=0.02 cfs 0.022 af Primary=1.20 cfs 0.202 af Outflow=1.22 cfs 0.224 af

**Link 65L: West Development**

Inflow=10.61 cfs 4.135 af  
Primary=10.61 cfs 4.135 af

**Link 105L: East Development**

Inflow=12.97 cfs 1.657 af  
Primary=12.97 cfs 1.657 af

**Link 110L: Post-DevelopmentOutflow**

Inflow=14.90 cfs 5.793 af  
Primary=14.90 cfs 5.793 af

**Total Runoff Area = 57.370 ac Runoff Volume = 7.582 af Average Runoff Depth = 1.59"**  
**60.19% Pervious = 34.530 ac 39.81% Impervious = 22.840 ac**

**Proposed EAST\_2020-012**

Prepared by HP Inc.

HydroCAD® 10.00-25 s/n 11025 © 2019 HydroCAD Software Solutions LLC

MSE 24-hr 3 100 yr Rainfall=6.18"

Printed 11/11/2020

Page 108

Time span=0.00-48.00 hrs, dt=0.05 hrs, 961 points  
Runoff by SCS TR-20 method, UH=SCS, Weighted-CN  
Reach routing by Dyn-Stor-Ind method - Pond routing by Dyn-Stor-Ind method

**Subcatchment10: Subarea** Runoff Area=5.430 ac 41.62% Impervious Runoff Depth=3.54"  
Flow Length=975' Tc=33.3 min CN=76 Runoff=16.17 cfs 1.600 af

**Subcatchment20: Subarea** Runoff Area=6.860 ac 43.88% Impervious Runoff Depth=3.64"  
Flow Length=235' Slope=0.0400 '/' Tc=10.3 min CN=77 Runoff=37.29 cfs 2.079 af

**Subcatchment30: Subarea** Runoff Area=17.030 ac 48.03% Impervious Runoff Depth=3.84"  
Flow Length=1,365' Tc=25.6 min CN=79 Runoff=63.90 cfs 5.451 af

**Subcatchment40: Subarea** Runoff Area=3.950 ac 54.43% Impervious Runoff Depth=4.05"  
Flow Length=550' Tc=8.7 min CN=81 Runoff=25.36 cfs 1.333 af

**Subcatchment45: Subarea** Runoff Area=2.400 ac 17.50% Impervious Runoff Depth=2.67"  
Flow Length=325' Tc=9.0 min CN=67 Runoff=10.20 cfs 0.533 af

**Subcatchment50: Subarea** Runoff Area=3.630 ac 21.49% Impervious Runoff Depth=2.85"  
Flow Length=60' Tc=6.4 min CN=69 Runoff=18.42 cfs 0.863 af

**Subcatchment60: Subarea** Runoff Area=2.330 ac 16.74% Impervious Runoff Depth=2.67"  
Flow Length=220' Slope=0.0400 '/' Tc=9.1 min CN=67 Runoff=9.79 cfs 0.518 af

**Subcatchment70: Subarea** Runoff Area=2.690 ac 18.22% Impervious Runoff Depth=2.76"  
Flow Length=260' Tc=22.5 min CN=68 Runoff=7.76 cfs 0.619 af

**Subcatchment80: Subarea** Runoff Area=9.660 ac 43.89% Impervious Runoff Depth=3.64"  
Flow Length=1,855' Tc=29.4 min CN=77 Runoff=31.77 cfs 2.928 af

**Subcatchment90: Subarea** Runoff Area=1.270 ac 28.35% Impervious Runoff Depth=3.04"  
Flow Length=45' Slope=0.0500 '/' Tc=6.0 min CN=71 Runoff=6.94 cfs 0.322 af

**Subcatchment100: Subarea** Runoff Area=2.120 ac 26.42% Impervious Runoff Depth=3.04"  
Flow Length=275' Tc=9.6 min CN=71 Runoff=9.98 cfs 0.538 af

**Pond 10P: Future Pond** Peak Elev=93.93' Storage=0.712 af Inflow=16.17 cfs 1.600 af  
Outflow=5.20 cfs 1.594 af

**Pond 20P: Pond** Peak Elev=63.96' Storage=0.929 af Inflow=37.29 cfs 2.079 af  
Outflow=9.70 cfs 2.026 af

**Pond 30P: Pond** Peak Elev=56.87' Storage=2.081 af Inflow=75.54 cfs 9.070 af  
Primary=0.41 cfs 0.638 af Secondary=57.91 cfs 7.627 af Tertiary=0.00 cfs 0.000 af Outflow=58.23 cfs 8.265 af

**Pond 40P: Pond** Peak Elev=58.80' Storage=0.942 af Inflow=25.63 cfs 1.951 af  
Outflow=2.51 cfs 1.718 af

**Pond 45B: Infiltration Basin** Peak Elev=56.82' Storage=2.287 af Inflow=60.71 cfs 10.516 af  
Discarded=0.11 cfs 0.226 af Primary=22.28 cfs 9.576 af Outflow=22.39 cfs 9.802 af



**Proposed\_EAST\_2020-012**

Prepared by HP Inc.

HydroCAD® 10.00-25 s/n 11025 © 2019 HydroCAD Software Solutions LLC

MSE 24-hr 3 100 yr Rainfall=6.18"

Printed 11/11/2020

Page 109

**Pond 70B: Dry Basin**

Peak Elev=65.62' Storage=0.352 af Inflow=7.76 cfs 0.619 af  
Outflow=1.00 cfs 0.618 af

**Pond 80P: Pond**

Peak Elev=58.60' Storage=0.543 af Inflow=31.77 cfs 2.928 af  
Outflow=27.36 cfs 2.923 af

**Pond 90B: Rain Garden**

Peak Elev=60.83' Storage=0.091 af Inflow=6.94 cfs 0.322 af  
Discarded=0.01 cfs 0.016 af Primary=3.45 cfs 0.307 af Outflow=3.47 cfs 0.322 af

**Pond 100B: Rain Garden**

Peak Elev=56.14' Storage=0.169 af Inflow=9.98 cfs 0.538 af  
Discarded=0.02 cfs 0.025 af Primary=4.20 cfs 0.513 af Outflow=4.23 cfs 0.538 af

**Link 65L: West Development**

Inflow=27.94 cfs 10.957 af  
Primary=27.94 cfs 10.957 af

**Link 105L: East Development**

Inflow=33.35 cfs 3.743 af  
Primary=33.35 cfs 3.743 af

**Link 110L: Post-DevelopmentOutflow**

Inflow=51.18 cfs 14.700 af  
Primary=51.18 cfs 14.700 af

**Total Runoff Area = 57.370 ac Runoff Volume = 16.783 af Average Runoff Depth = 3.51"**  
**60.19% Pervious = 34.530 ac 39.81% Impervious = 22.840 ac**

**Summary for Subcatchment 10: Subarea**

Runoff = 16.17 cfs @ 12.47 hrs, Volume= 1.600 af, Depth= 3.54"

Runoff by SCS TR-20 method, UH=SCS, Weighted-CN, Time Span= 0.00-48.00 hrs, dt= 0.05 hrs  
 MSE 24-hr 3 100 yr Rainfall=6.18"

Area (ac)	CN	Description
* 3.170	61	grass - B soils
* 0.130	98	water
* 2.130	98	impervious
5.430	76	Weighted Average
3.170		58.38% Pervious Area
2.260		41.62% Impervious Area

Tc (min)	Length (feet)	Slope (ft/ft)	Velocity (ft/sec)	Capacity (cfs)	Description
30.2	230	0.0200	0.13		<b>Sheet Flow,</b> Grass: Dense n= 0.240 P2= 2.70"
3.1	745	0.0600	3.94		<b>Shallow Concentrated Flow,</b> Unpaved Kv= 16.1 fps
33.3	975	Total			

**Subcatchment 10: Subarea**

Hydrograph

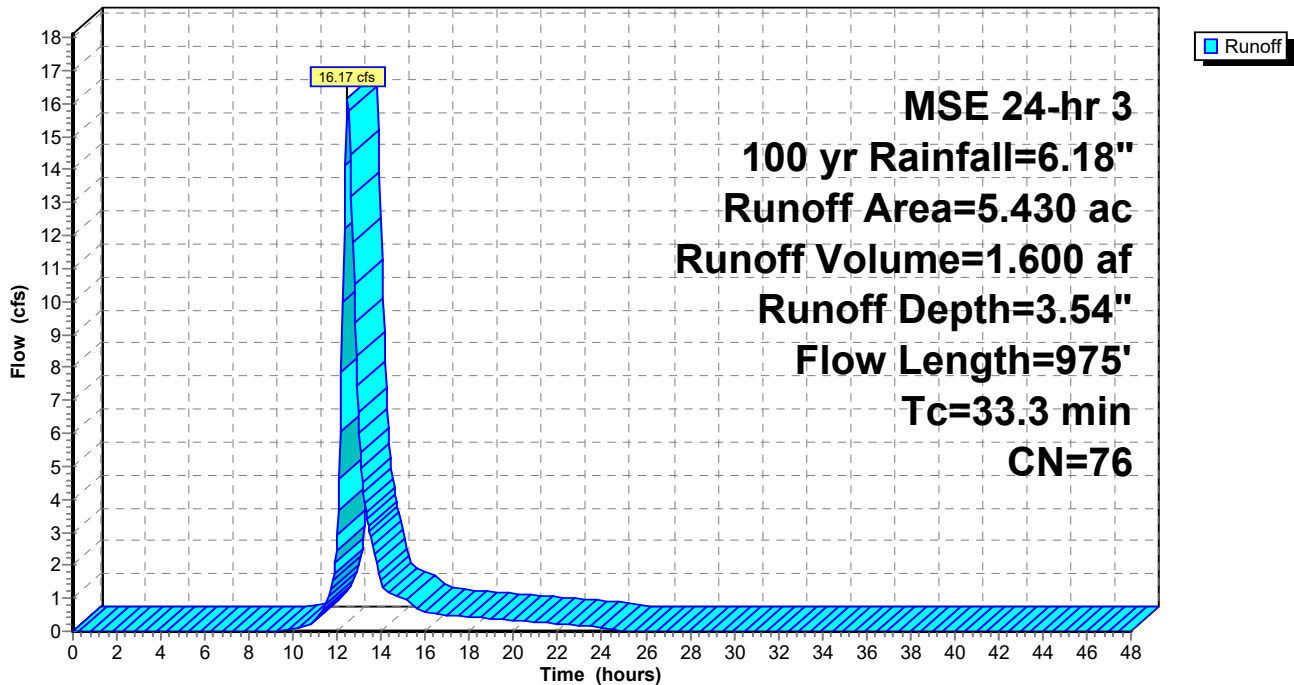

**Summary for Subcatchment 20: Subarea**

Runoff = 37.29 cfs @ 12.18 hrs, Volume= 2.079 af, Depth= 3.64"

Runoff by SCS TR-20 method, UH=SCS, Weighted-CN, Time Span= 0.00-48.00 hrs, dt= 0.05 hrs  
MSE 24-hr 3 100 yr Rainfall=6.18"

Area (ac)	CN	Description
* 3.850	61	grass - B soils
* 0.320	98	water
* 2.690	98	impervious
6.860	77	Weighted Average
3.850		56.12% Pervious Area
3.010		43.88% Impervious Area

Tc (min)	Length (feet)	Slope (ft/ft)	Velocity (ft/sec)	Capacity (cfs)	Description
9.8	80	0.0400	0.14		<b>Sheet Flow,</b> Grass: Dense n= 0.240 P2= 2.70"
0.5	155		5.00		<b>Direct Entry, Pipe</b>
10.3	235	Total			

**Subcatchment 20: Subarea**

Hydrograph

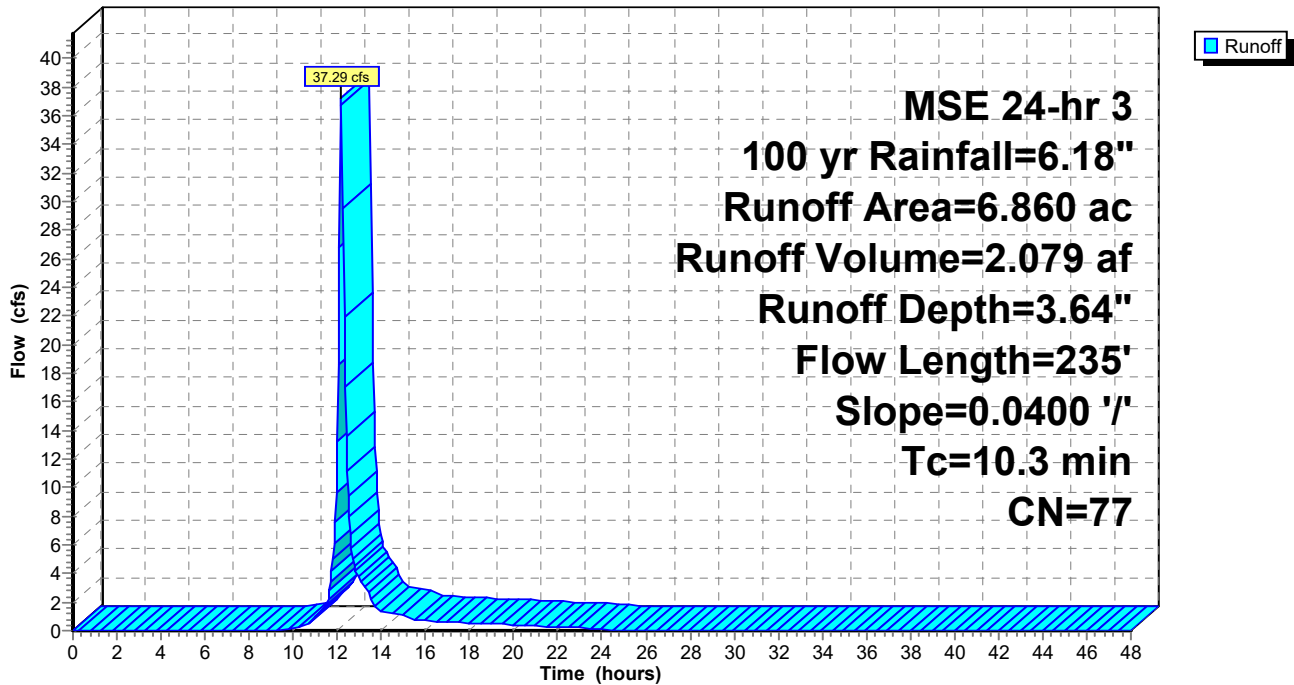

**Summary for Subcatchment 30: Subarea**

Runoff = 63.90 cfs @ 12.37 hrs, Volume= 5.451 af, Depth= 3.84"

Runoff by SCS TR-20 method, UH=SCS, Weighted-CN, Time Span= 0.00-48.00 hrs, dt= 0.05 hrs  
 MSE 24-hr 3 100 yr Rainfall=6.18"

Area (ac)	CN	Description
* 8.850	61	grass - B soils
* 0.400	98	water
* 7.780	98	impervious
17.030	79	Weighted Average
8.850		51.97% Pervious Area
8.180		48.03% Impervious Area

Tc (min)	Length (feet)	Slope (ft/ft)	Velocity (ft/sec)	Capacity (cfs)	Description
18.8	180	0.0400	0.16		<b>Sheet Flow,</b> Grass: Dense n= 0.240 P2= 2.70"
2.5	30	0.1700	0.20		<b>Sheet Flow,</b> Grass: Dense n= 0.240 P2= 2.70"
0.7	65	0.0100	1.61		<b>Shallow Concentrated Flow,</b> Unpaved Kv= 16.1 fps
3.6	1,090		5.00		<b>Direct Entry, Pipe</b>
25.6	1,365	Total			

**Subcatchment 30: Subarea**

Hydrograph

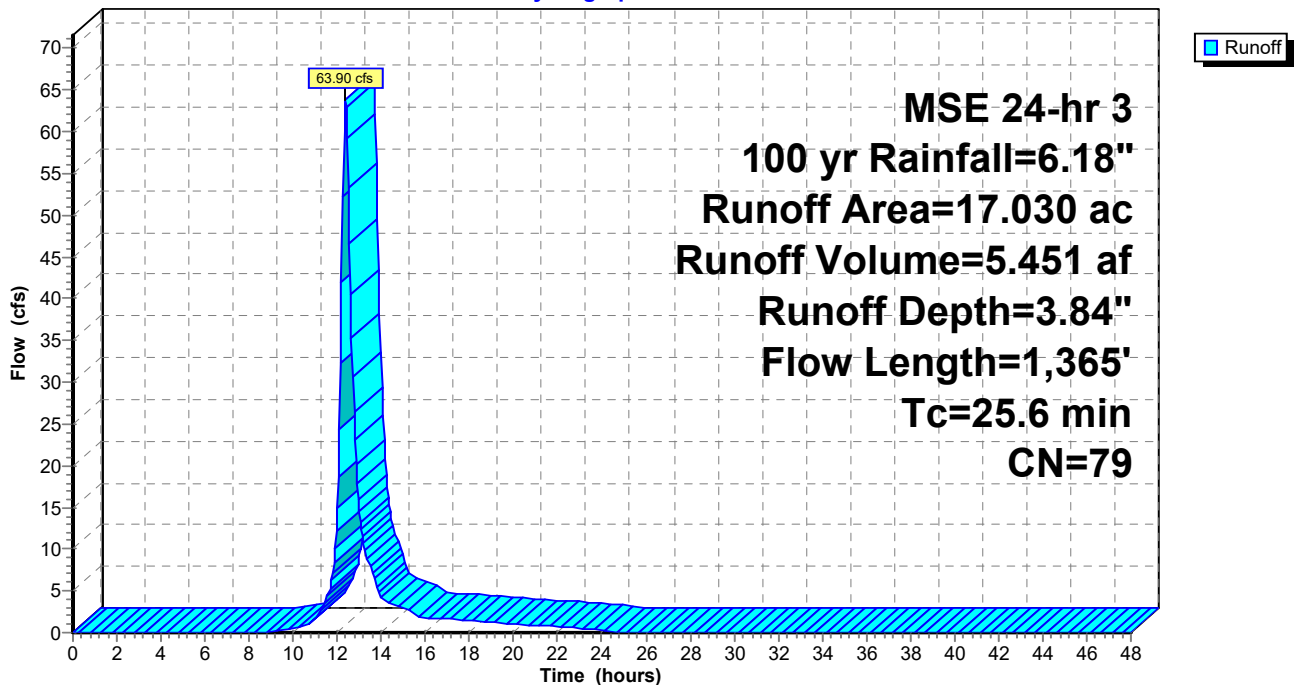

**Summary for Subcatchment 40: Subarea**

Runoff = 25.36 cfs @ 12.16 hrs, Volume= 1.333 af, Depth= 4.05"

Runoff by SCS TR-20 method, UH=SCS, Weighted-CN, Time Span= 0.00-48.00 hrs, dt= 0.05 hrs  
 MSE 24-hr 3 100 yr Rainfall=6.18"

Area (ac)	CN	Description
* 1.800	61	grass - B soils
* 0.140	98	water
* 2.010	98	impervious
3.950	81	Weighted Average
1.800		45.57% Pervious Area
2.150		54.43% Impervious Area

Tc (min)	Length (feet)	Slope (ft/ft)	Velocity (ft/sec)	Capacity (cfs)	Description
6.4	70	0.0900	0.18		<b>Sheet Flow,</b> Grass: Dense n= 0.240 P2= 2.70"
1.3	175	0.0200	2.28		<b>Shallow Concentrated Flow,</b> Unpaved Kv= 16.1 fps
1.0	305		5.00		<b>Direct Entry, Pipe</b>
8.7	550	Total			

**Subcatchment 40: Subarea**

Hydrograph

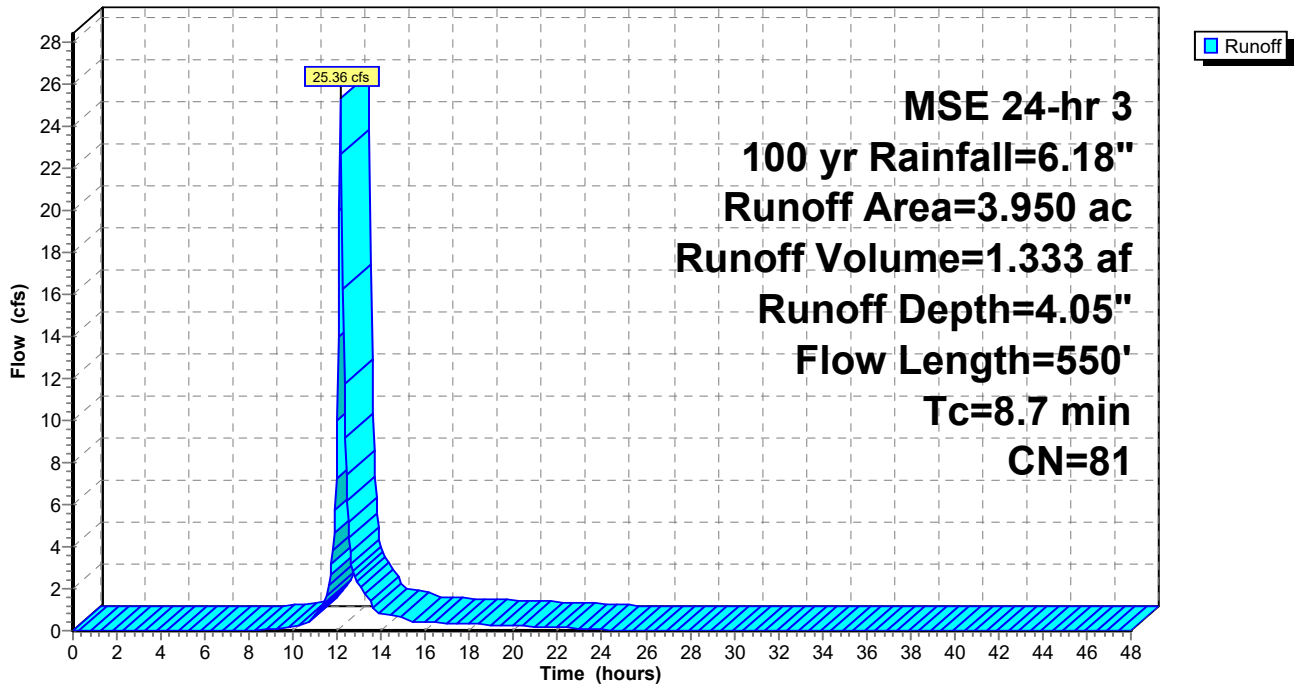

**Proposed EAST\_2020-012**

Prepared by HP Inc.

HydroCAD® 10.00-25 s/n 11025 © 2019 HydroCAD Software Solutions LLC

MSE 24-hr 3 100 yr Rainfall=6.18"

Printed 11/11/2020

Page 114

**Summary for Subcatchment 45: Subarea**

Runoff = 10.20 cfs @ 12.17 hrs, Volume= 0.533 af, Depth= 2.67"

Runoff by SCS TR-20 method, UH=SCS, Weighted-CN, Time Span= 0.00-48.00 hrs, dt= 0.05 hrs  
MSE 24-hr 3 100 yr Rainfall=6.18"

Area (ac)	CN	Description
* 1.980	61	grass - B soils
* 0.420	98	impervious
2.400	67	Weighted Average
1.980		82.50% Pervious Area
0.420		17.50% Impervious Area

Tc (min)	Length (feet)	Slope (ft/ft)	Velocity (ft/sec)	Capacity (cfs)	Description
5.7	40	0.0400	0.12		<b>Sheet Flow,</b> Grass: Dense n= 0.240 P2= 2.70"
1.0	10	0.2000	0.17		<b>Sheet Flow,</b> Grass: Dense n= 0.240 P2= 2.70"
2.3	275	0.0150	1.97		<b>Shallow Concentrated Flow,</b> Unpaved Kv= 16.1 fps
9.0	325	Total			

**Subcatchment 45: Subarea**

Hydrograph

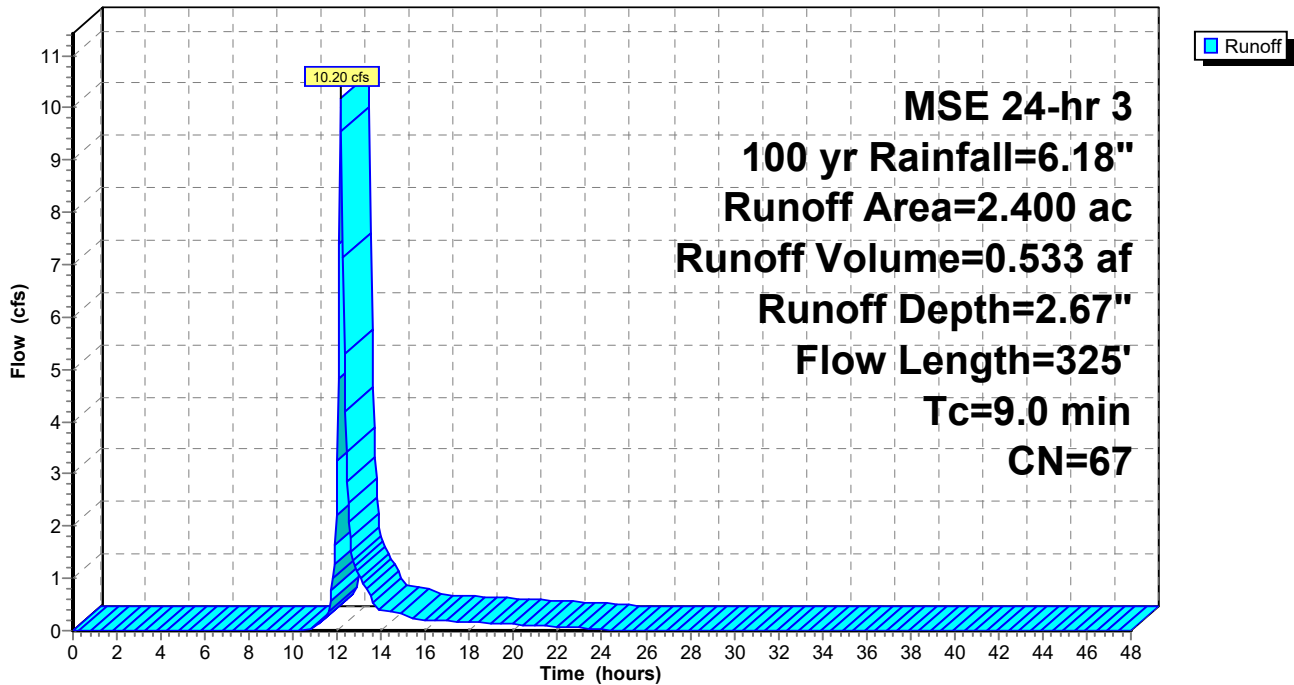

**Summary for Subcatchment 50: Subarea**

Runoff = 18.42 cfs @ 12.14 hrs, Volume= 0.863 af, Depth= 2.85"

Runoff by SCS TR-20 method, UH=SCS, Weighted-CN, Time Span= 0.00-48.00 hrs, dt= 0.05 hrs  
 MSE 24-hr 3 100 yr Rainfall=6.18"

Area (ac)	CN	Description
* 2.850	61	grass - B soils
* 0.780	98	impervious
3.630	69	Weighted Average
2.850		78.51% Pervious Area
0.780		21.49% Impervious Area

Tc (min)	Length (feet)	Slope (ft/ft)	Velocity (ft/sec)	Capacity (cfs)	Description
2.3	30	0.2200	0.22		<b>Sheet Flow,</b> Grass: Dense n= 0.240 P2= 2.70"
4.1	30	0.0500	0.12		<b>Sheet Flow,</b> Grass: Dense n= 0.240 P2= 2.70"
6.4	60	Total			

**Subcatchment 50: Subarea**

Hydrograph

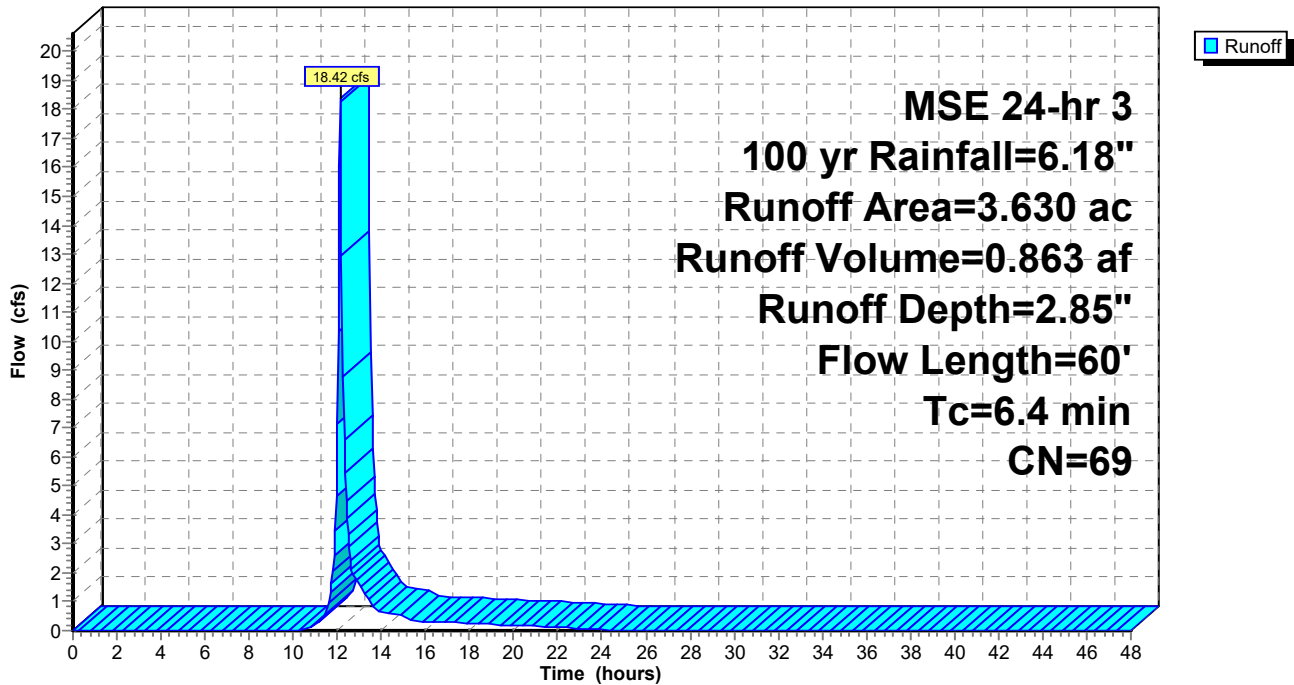

**Summary for Subcatchment 60: Subarea**

Runoff = 9.79 cfs @ 12.17 hrs, Volume= 0.518 af, Depth= 2.67"

Runoff by SCS TR-20 method, UH=SCS, Weighted-CN, Time Span= 0.00-48.00 hrs, dt= 0.05 hrs  
MSE 24-hr 3 100 yr Rainfall=6.18"

Area (ac)	CN	Description
* 1.940	61	grass - B soils
* 0.390	98	impervious
2.330	67	Weighted Average
1.940		83.26% Pervious Area
0.390		16.74% Impervious Area

Tc (min)	Length (feet)	Slope (ft/ft)	Velocity (ft/sec)	Capacity (cfs)	Description
8.3	65	0.0400	0.13		<b>Sheet Flow,</b> Grass: Dense n= 0.240 P2= 2.70"
0.8	155	0.0400	3.22		<b>Shallow Concentrated Flow,</b> Unpaved Kv= 16.1 fps
9.1	220	Total			

**Subcatchment 60: Subarea**

Hydrograph

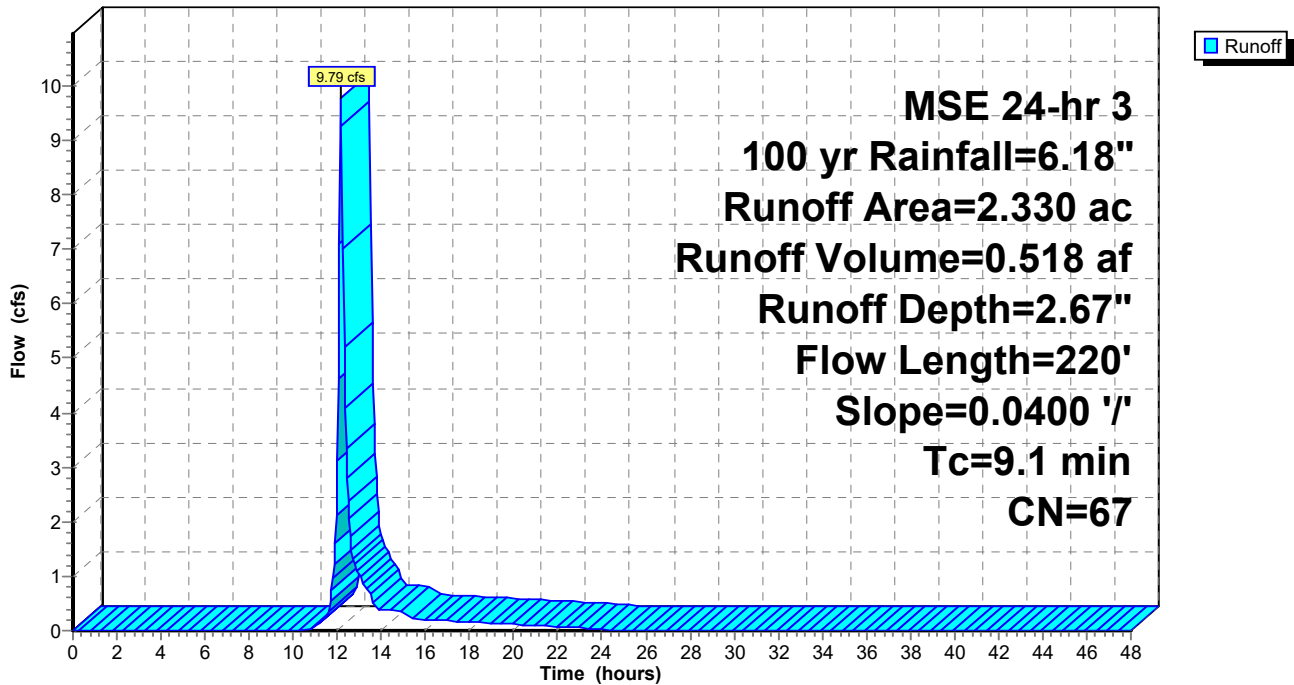



**Proposed EAST\_2020-012**

Prepared by HP Inc.

HydroCAD® 10.00-25 s/n 11025 © 2019 HydroCAD Software Solutions LLC

MSE 24-hr 3 100 yr Rainfall=6.18"

Printed 11/11/2020

Page 117

**Summary for Subcatchment 70: Subarea**

Runoff = 7.76 cfs @ 12.34 hrs, Volume= 0.619 af, Depth= 2.76"

Runoff by SCS TR-20 method, UH=SCS, Weighted-CN, Time Span= 0.00-48.00 hrs, dt= 0.05 hrs  
MSE 24-hr 3 100 yr Rainfall=6.18"

Area (ac)	CN	Description
* 2.200	61	grass - B soils
* 0.490	98	impervious
2.690	68	Weighted Average
2.200		81.78% Pervious Area
0.490		18.22% Impervious Area

Tc (min)	Length (feet)	Slope (ft/ft)	Velocity (ft/sec)	Capacity (cfs)	Description
18.4	195	0.0500	0.18		<b>Sheet Flow,</b> Grass: Dense n= 0.240 P2= 2.70"
4.1	65	0.2300	0.26		<b>Sheet Flow,</b> Grass: Dense n= 0.240 P2= 2.70"
22.5	260	Total			

**Subcatchment 70: Subarea**

Hydrograph

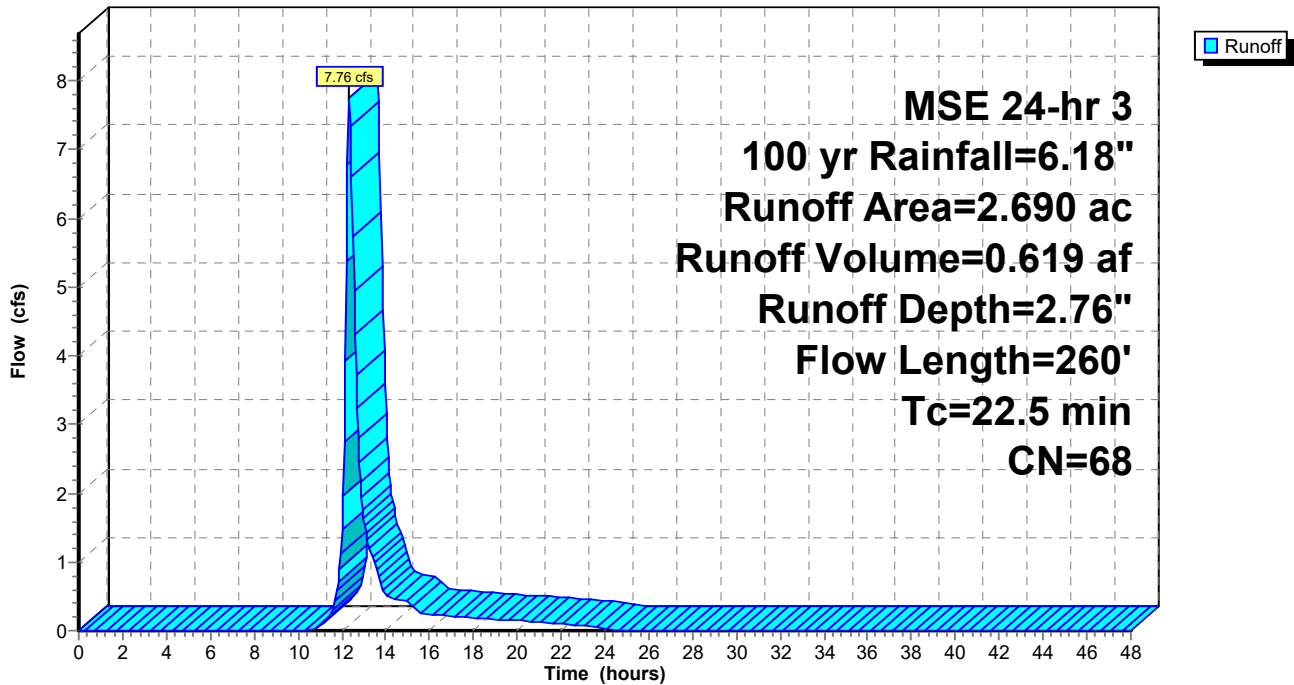

**Summary for Subcatchment 80: Subarea**

Runoff = 31.77 cfs @ 12.42 hrs, Volume= 2.928 af, Depth= 3.64"

Runoff by SCS TR-20 method, UH=SCS, Weighted-CN, Time Span= 0.00-48.00 hrs, dt= 0.05 hrs  
MSE 24-hr 3 100 yr Rainfall=6.18"

Area (ac)	CN	Description
* 5.420	61	grass - B soils
* 0.130	98	water
* 4.110	98	impervious
9.660	77	Weighted Average
5.420		56.11% Pervious Area
4.240		43.89% Impervious Area

Tc (min)	Length (feet)	Slope (ft/ft)	Velocity (ft/sec)	Capacity (cfs)	Description
16.2	210	0.0800	0.22		<b>Sheet Flow,</b> Grass: Dense n= 0.240 P2= 2.70"
7.0	90	0.1200	0.22		<b>Sheet Flow,</b> Grass: Dense n= 0.240 P2= 2.70"
0.4	130	0.1200	5.58		<b>Shallow Concentrated Flow,</b> Unpaved Kv= 16.1 fps
0.1	25	0.2400	7.89		<b>Shallow Concentrated Flow,</b> Unpaved Kv= 16.1 fps
2.1	400	0.0400	3.22		<b>Shallow Concentrated Flow,</b> Unpaved Kv= 16.1 fps
1.0	220	0.0300	3.52		<b>Shallow Concentrated Flow,</b> Paved Kv= 20.3 fps
2.6	780		5.00		<b>Direct Entry, Pipe</b>
29.4	1,855	Total			

### Subcatchment 80: Subarea

Hydrograph

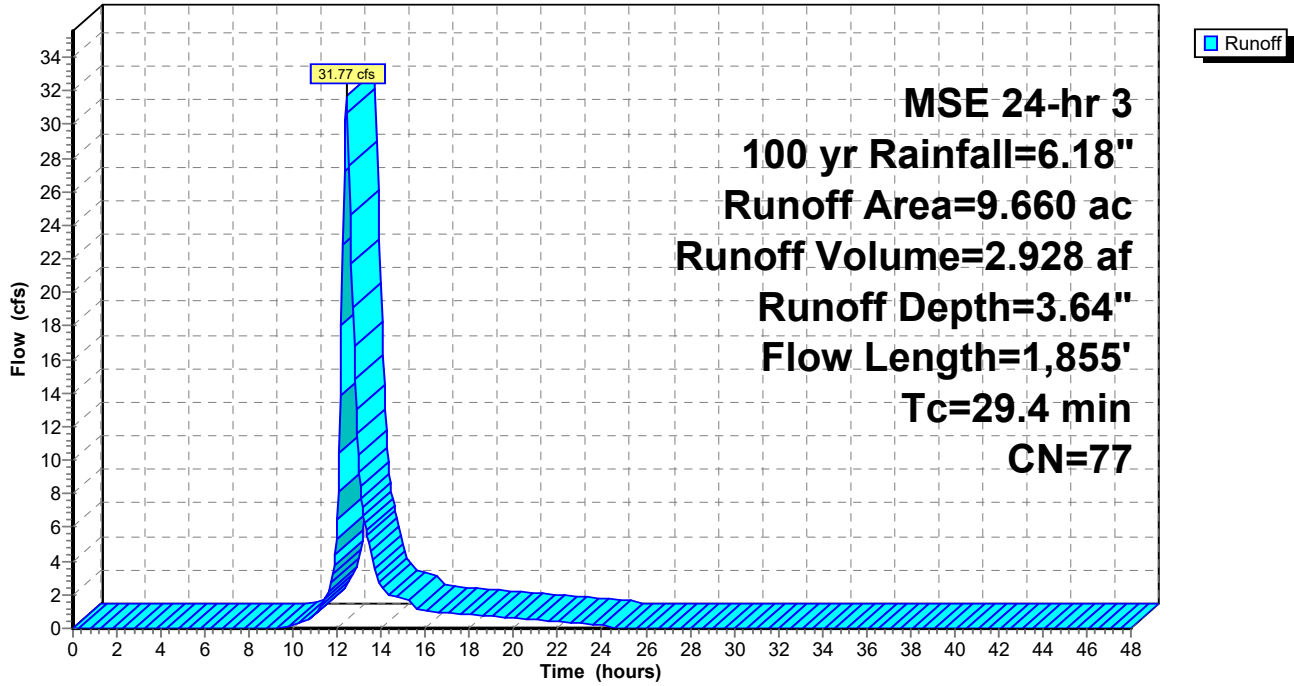

**Summary for Subcatchment 90: Subarea**

Runoff = 6.94 cfs @ 12.13 hrs, Volume= 0.322 af, Depth= 3.04"

Runoff by SCS TR-20 method, UH=SCS, Weighted-CN, Time Span= 0.00-48.00 hrs, dt= 0.05 hrs  
 MSE 24-hr 3 100 yr Rainfall=6.18"

Area (ac)	CN	Description
* 0.910	61	grass - B soils
* 0.360	98	impervious
1.270	71	Weighted Average
0.910		71.65% Pervious Area
0.360		28.35% Impervious Area

Tc (min)	Length (feet)	Slope (ft/ft)	Velocity (ft/sec)	Capacity (cfs)	Description
5.7	45	0.0500	0.13		<b>Sheet Flow,</b> Grass: Dense n= 0.240 P2= 2.70"
5.7	45	Total, Increased to minimum Tc = 6.0 min			

**Subcatchment 90: Subarea**

Hydrograph

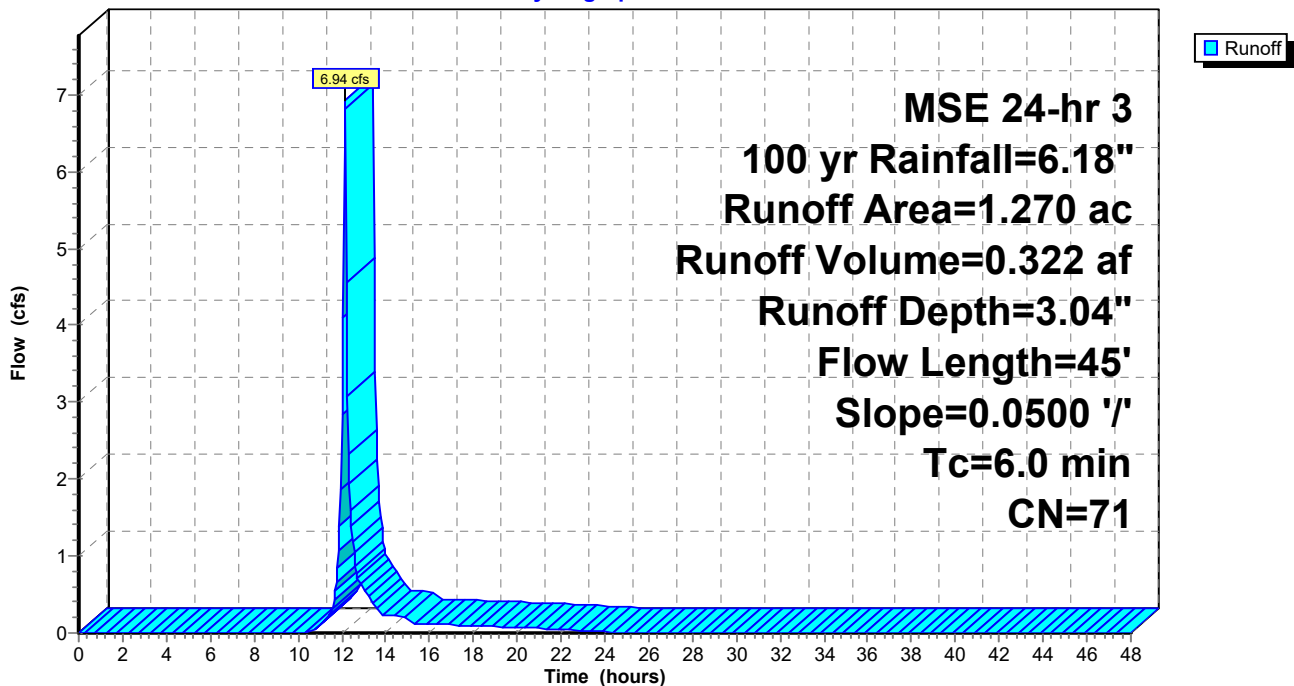

**Summary for Subcatchment 100: Subarea**

Runoff = 9.98 cfs @ 12.17 hrs, Volume= 0.538 af, Depth= 3.04"

Runoff by SCS TR-20 method, UH=SCS, Weighted-CN, Time Span= 0.00-48.00 hrs, dt= 0.05 hrs  
 MSE 24-hr 3 100 yr Rainfall=6.18"

Area (ac)	CN	Description
* 1.560	61	grass - B soils
* 0.560	98	impervious
2.120	71	Weighted Average
1.560		73.58% Pervious Area
0.560		26.42% Impervious Area

Tc (min)	Length (feet)	Slope (ft/ft)	Velocity (ft/sec)	Capacity (cfs)	Description
8.1	70	0.0500	0.14		<b>Sheet Flow,</b> Grass: Dense n= 0.240 P2= 2.70"
1.5	205	0.0200	2.28		<b>Shallow Concentrated Flow,</b> Unpaved Kv= 16.1 fps
9.6	275	Total			

**Subcatchment 100: Subarea**

Hydrograph

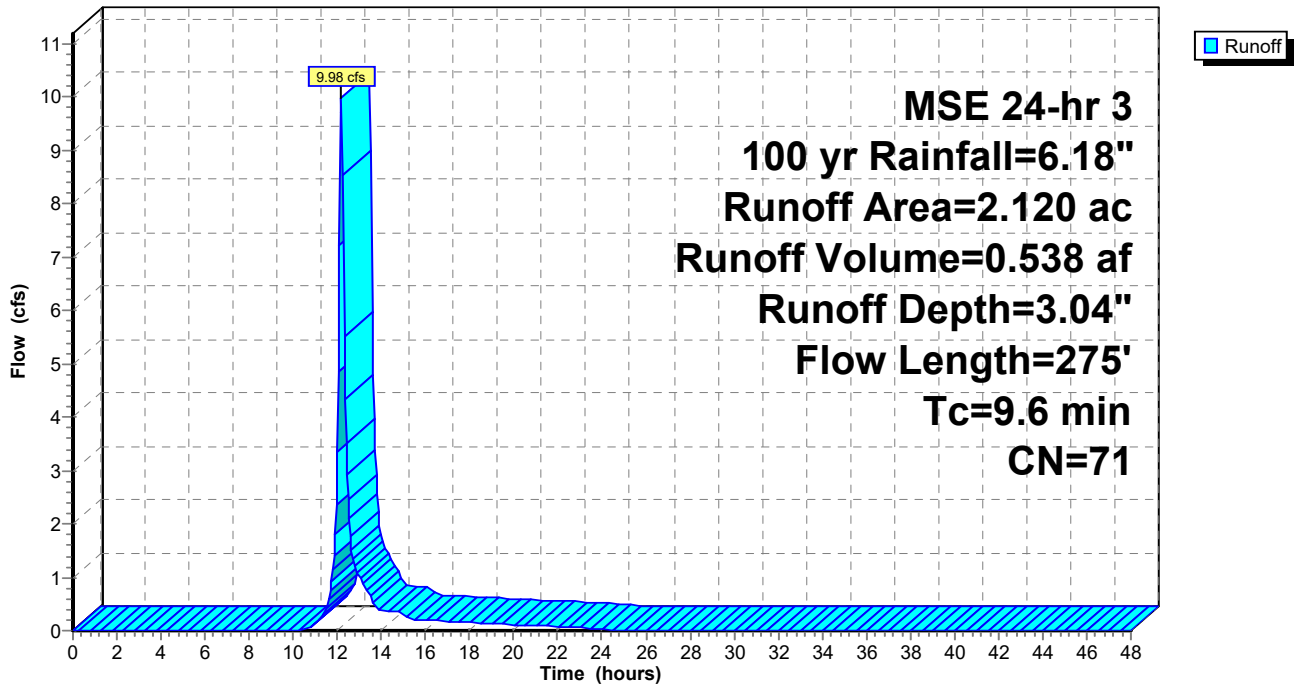

**Summary for Pond 10P: Future Pond**

Inflow Area = 5.430 ac, 41.62% Impervious, Inflow Depth = 3.54" for 100 yr event  
 Inflow = 16.17 cfs @ 12.47 hrs, Volume= 1.600 af  
 Outflow = 5.20 cfs @ 13.07 hrs, Volume= 1.594 af, Atten= 68%, Lag= 36.1 min  
 Primary = 5.20 cfs @ 13.07 hrs, Volume= 1.594 af

Routing by Dyn-Stor-Ind method, Time Span= 0.00-48.00 hrs, dt= 0.05 hrs  
 Peak Elev= 93.93' @ 13.07 hrs Surf.Area= 0.238 ac Storage= 0.712 af

Plug-Flow detention time= 174.9 min calculated for 1.594 af (100% of inflow)  
 Center-of-Mass det. time= 172.3 min ( 997.9 - 825.5 )

Volume	Invert	Avail.Storage	Storage Description
#1	90.00'	0.987 af	<b>Custom Stage Data (Conic)</b> Listed below (Recalc)

Elevation (feet)	Surf.Area (acres)	Inc.Store (acre-feet)	Cum.Store (acre-feet)	Wet.Area (acres)
90.00	0.130	0.000	0.000	0.130
92.00	0.180	0.309	0.309	0.182
94.00	0.240	0.419	0.727	0.244
95.00	0.280	0.260	0.987	0.285

Device	Routing	Invert	Outlet Devices
#1	Primary	90.00'	<b>3.0" Vert. Orifice/Grate</b> C= 0.600
#2	Primary	91.25'	<b>11.0" Vert. Orifice/Grate</b> C= 0.600
#3	Primary	94.00'	<b>10.0' long x 10.0' breadth Broad-Crested Rectangular Weir</b> Head (feet) 0.20 0.40 0.60 0.80 1.00 1.20 1.40 1.60 Coef. (English) 2.49 2.56 2.70 2.69 2.68 2.69 2.67 2.64

**Primary OutFlow** Max=5.20 cfs @ 13.07 hrs HW=93.93' TW=56.78' (Dynamic Tailwater)

- 1=Orifice/Grate (Orifice Controls 0.46 cfs @ 9.40 fps)
- 2=Orifice/Grate (Orifice Controls 4.74 cfs @ 7.18 fps)
- 3=Broad-Crested Rectangular Weir ( Controls 0.00 cfs)

### Pond 10P: Future Pond

Hydrograph

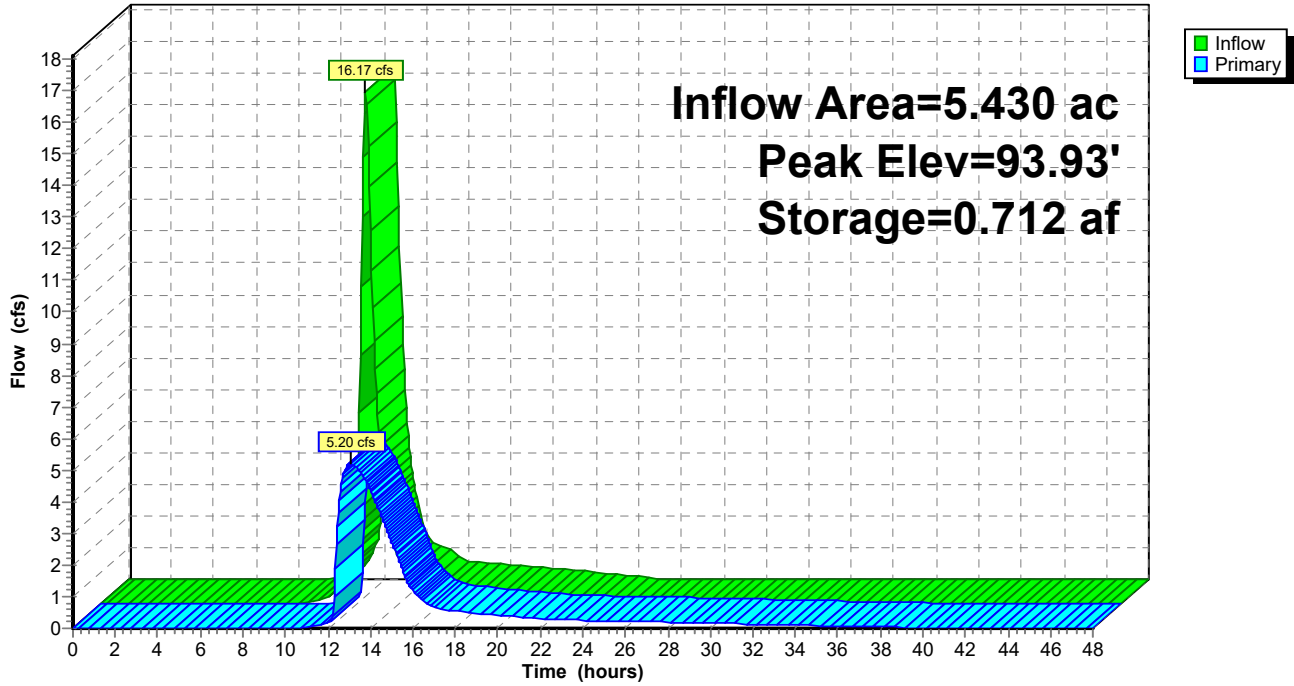

**Summary for Pond 20P: Pond**

Inflow Area = 6.860 ac, 43.88% Impervious, Inflow Depth = 3.64" for 100 yr event  
 Inflow = 37.29 cfs @ 12.18 hrs, Volume= 2.079 af  
 Outflow = 9.70 cfs @ 12.49 hrs, Volume= 2.026 af, Atten= 74%, Lag= 18.8 min  
 Primary = 9.70 cfs @ 12.49 hrs, Volume= 2.026 af

Routing by Dyn-Stor-Ind method, Time Span= 0.00-48.00 hrs, dt= 0.05 hrs  
 Peak Elev= 63.96' @ 12.49 hrs Surf.Area= 0.605 ac Storage= 0.929 af

Plug-Flow detention time= 206.7 min calculated for 2.026 af (97% of inflow)  
 Center-of-Mass det. time= 192.6 min ( 995.0 - 802.5 )

Volume	Invert	Avail.Storage	Storage Description	
#1	62.00'	2.419 af	<b>Custom Stage Data (Conic)</b> Listed below (Recalc)	
Elevation (feet)	Surf.Area (acres)	Inc.Store (acre-feet)	Cum.Store (acre-feet)	Wet.Area (acres)
62.00	0.320	0.000	0.000	0.320
63.00	0.490	0.402	0.402	0.490
64.00	0.610	0.549	0.951	0.611
65.00	0.730	0.669	1.620	0.732
66.00	0.870	0.799	2.419	0.873

Device	Routing	Invert	Outlet Devices
#1	Primary	58.00'	<b>18.0" Round Culvert</b> L= 425.0' RCP, square edge headwall, Ke= 0.500 Inlet / Outlet Invert= 58.00' / 53.00' S= 0.0118 '/ Cc= 0.900 n= 0.013, Flow Area= 1.77 sf
#2	Device 1	62.00'	<b>3.0" Vert. Orifice/Grate</b> C= 0.600
#3	Device 1	62.75'	<b>18.0" Horiz. Orifice/Grate</b> C= 0.600 Limited to weir flow at low heads
#4	Primary	64.00'	<b>10.0' long x 10.0' breadth Broad-Crested Rectangular Weir</b> Head (feet) 0.20 0.40 0.60 0.80 1.00 1.20 1.40 1.60 Coef. (English) 2.49 2.56 2.70 2.69 2.68 2.69 2.67 2.64

**Primary OutFlow** Max=9.69 cfs @ 12.49 hrs HW=63.96' TW=56.64' (Dynamic Tailwater)

- 1=Culvert (Passes 9.69 cfs of 12.61 cfs potential flow)
- 2=Orifice/Grate (Orifice Controls 0.32 cfs @ 6.53 fps)
- 3=Orifice/Grate (Orifice Controls 9.37 cfs @ 5.30 fps)
- 4=Broad-Crested Rectangular Weir ( Controls 0.00 cfs)



### Pond 20P: Pond

#### Hydrograph

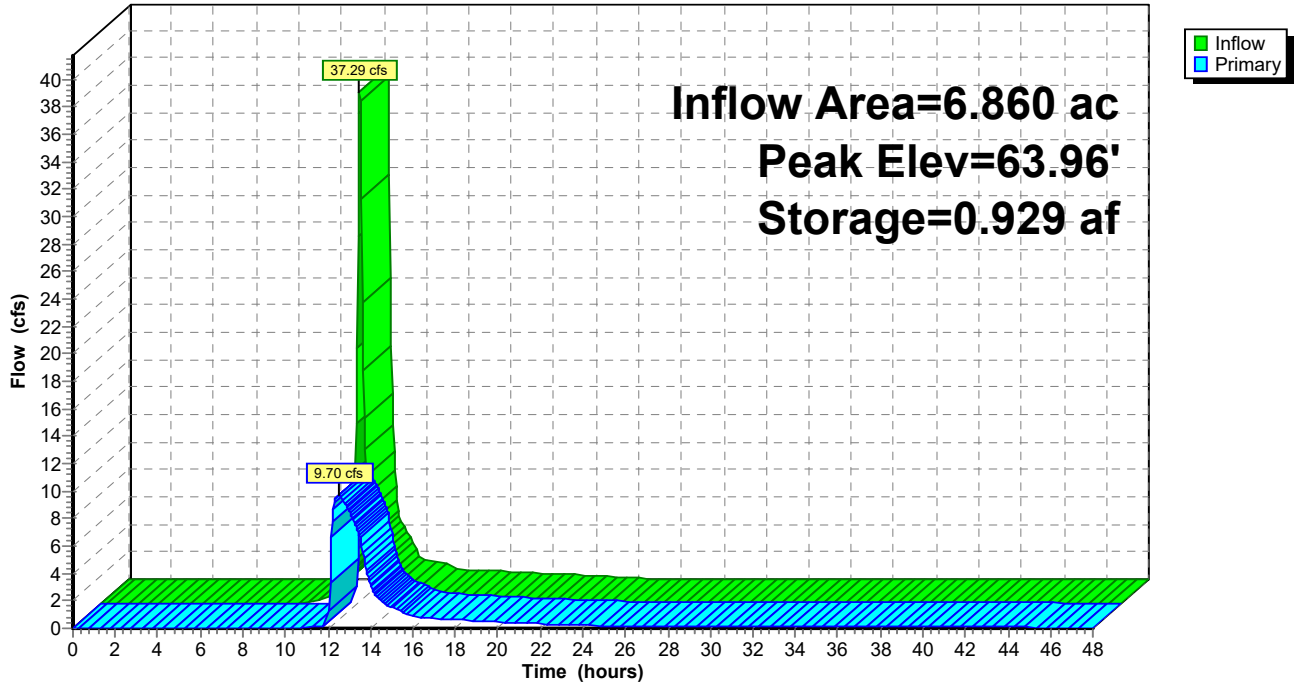

**Summary for Pond 30P: Pond**

Inflow Area = 29.320 ac, 45.87% Impervious, Inflow Depth > 3.71" for 100 yr event  
 Inflow = 75.54 cfs @ 12.38 hrs, Volume= 9.070 af  
 Outflow = 58.23 cfs @ 12.56 hrs, Volume= 8.265 af, Atten= 23%, Lag= 10.9 min  
 Primary = 0.41 cfs @ 12.37 hrs, Volume= 0.638 af  
 Secondary = 57.91 cfs @ 12.56 hrs, Volume= 7.627 af  
 Tertiary = 0.00 cfs @ 0.00 hrs, Volume= 0.000 af

Routing by Dyn-Stor-Ind method, Time Span= 0.00-48.00 hrs, dt= 0.05 hrs  
 Peak Elev= 56.87' @ 13.53 hrs Surf.Area= 0.698 ac Storage= 2.081 af

Plug-Flow detention time= 150.2 min calculated for 8.265 af (91% of inflow)  
 Center-of-Mass det. time= 77.6 min ( 963.9 - 886.3 )

Volume	Invert	Avail.Storage	Storage Description	
#1	53.00'	2.942 af	<b>Custom Stage Data (Conic)</b> Listed below (Recalc)	
Elevation (feet)	Surf.Area (acres)	Inc.Store (acre-feet)	Cum.Store (acre-feet)	Wet.Area (acres)
53.00	0.400	0.000	0.000	0.400
54.00	0.470	0.435	0.435	0.471
55.00	0.530	0.500	0.934	0.532
56.00	0.620	0.574	1.509	0.623
57.00	0.710	0.664	2.173	0.714
58.00	0.830	0.769	2.942	0.835

Device	Routing	Invert	Outlet Devices
#1	Primary	53.00'	<b>3.0" Vert. Orifice/Grate</b> C= 0.600
#2	Secondary	55.00'	<b>10.0' long x 10.0' breadth Broad-Crested Rectangular Weir</b> Head (feet) 0.20 0.40 0.60 0.80 1.00 1.20 1.40 1.60 Coef. (English) 2.49 2.56 2.70 2.69 2.68 2.69 2.67 2.64
#3	Tertiary	57.00'	<b>10.0' long x 10.0' breadth Broad-Crested Rectangular Weir</b> Head (feet) 0.20 0.40 0.60 0.80 1.00 1.20 1.40 1.60 Coef. (English) 2.49 2.56 2.70 2.69 2.68 2.69 2.67 2.64

**Primary OutFlow** Max=0.39 cfs @ 12.37 hrs HW=56.25' TW=53.56' (Dynamic Tailwater)  
 ↑1=**Orifice/Grate** (Orifice Controls 0.39 cfs @ 7.90 fps)

**Secondary OutFlow** Max=56.61 cfs @ 12.56 hrs HW=56.69' TW=55.24' (Dynamic Tailwater)  
 ↑2=**Broad-Crested Rectangular Weir**(Weir Controls 56.61 cfs @ 3.36 fps)

**Tertiary OutFlow** Max=0.00 cfs @ 0.00 hrs HW=53.00' TW=0.00' (Dynamic Tailwater)  
 ↑3=**Broad-Crested Rectangular Weir**( Controls 0.00 cfs)

### Pond 30P: Pond

Hydrograph

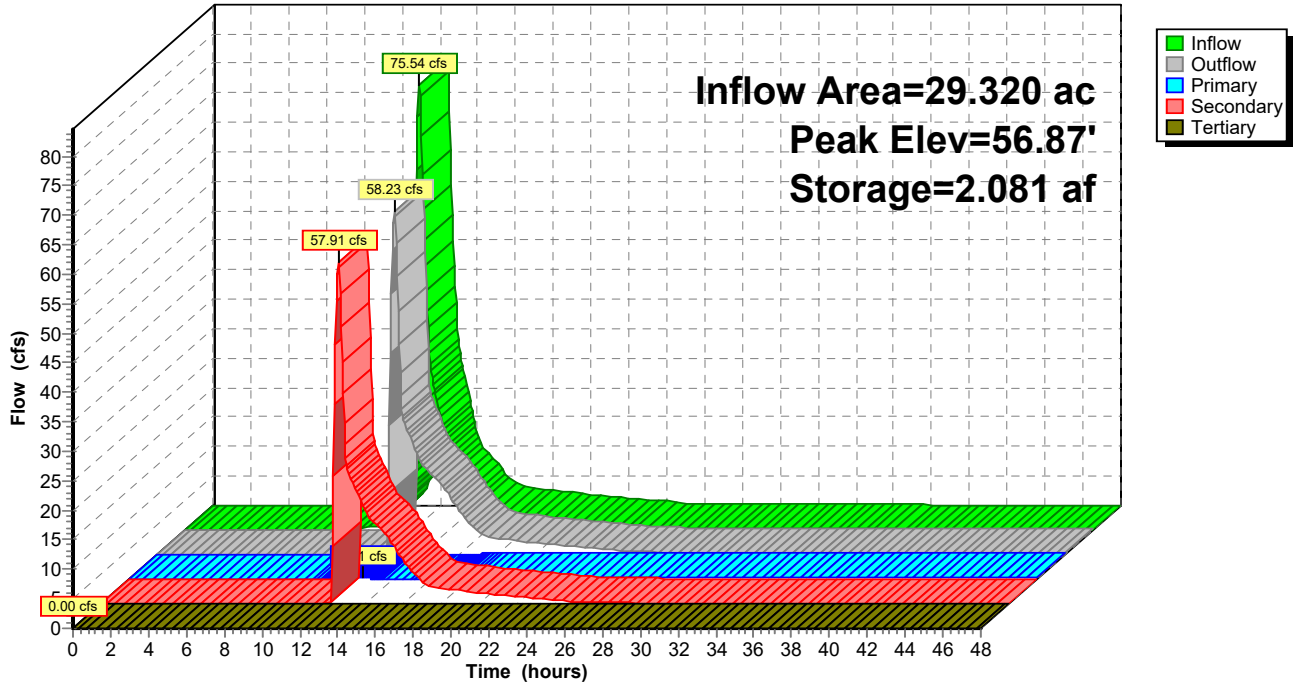

**Summary for Pond 40P: Pond**

Inflow Area = 6.640 ac, 39.76% Impervious, Inflow Depth = 3.53" for 100 yr event  
 Inflow = 25.63 cfs @ 12.16 hrs, Volume= 1.951 af  
 Outflow = 2.51 cfs @ 13.43 hrs, Volume= 1.718 af, Atten= 90%, Lag= 76.3 min  
 Primary = 2.51 cfs @ 13.43 hrs, Volume= 1.718 af

Routing by Dyn-Stor-Ind method, Time Span= 0.00-48.00 hrs, dt= 0.05 hrs  
 Peak Elev= 58.80' @ 13.43 hrs Surf.Area= 0.385 ac Storage= 0.942 af

Plug-Flow detention time= 649.5 min calculated for 1.716 af (88% of inflow)  
 Center-of-Mass det. time= 577.0 min ( 1,475.5 - 898.5 )

Volume	Invert	Avail.Storage	Storage Description
#1	55.00'	1.466 af	<b>Custom Stage Data (Conic)</b> Listed below (Recalc)

Elevation (feet)	Surf.Area (acres)	Inc.Store (acre-feet)	Cum.Store (acre-feet)	Wet.Area (acres)
55.00	0.130	0.000	0.000	0.130
56.00	0.180	0.154	0.154	0.180
57.00	0.250	0.214	0.368	0.251
58.00	0.330	0.289	0.657	0.331
59.00	0.400	0.364	1.022	0.402
60.00	0.490	0.444	1.466	0.493

Device	Routing	Invert	Outlet Devices
#1	Primary	55.00'	<b>3.0" Vert. Orifice/Grate</b> C= 0.600
#2	Primary	58.60'	<b>10.0' long x 10.0' breadth Broad-Crested Rectangular Weir</b> Head (feet) 0.20 0.40 0.60 0.80 1.00 1.20 1.40 1.60 Coef. (English) 2.49 2.56 2.70 2.69 2.68 2.69 2.67 2.64

**Primary OutFlow** Max=2.50 cfs @ 13.43 hrs HW=58.80' TW=56.82' (Dynamic Tailwater)

- 1=Orifice/Grate (Orifice Controls 0.33 cfs @ 6.77 fps)
- 2=Broad-Crested Rectangular Weir (Weir Controls 2.17 cfs @ 1.10 fps)

### Pond 40P: Pond

Hydrograph

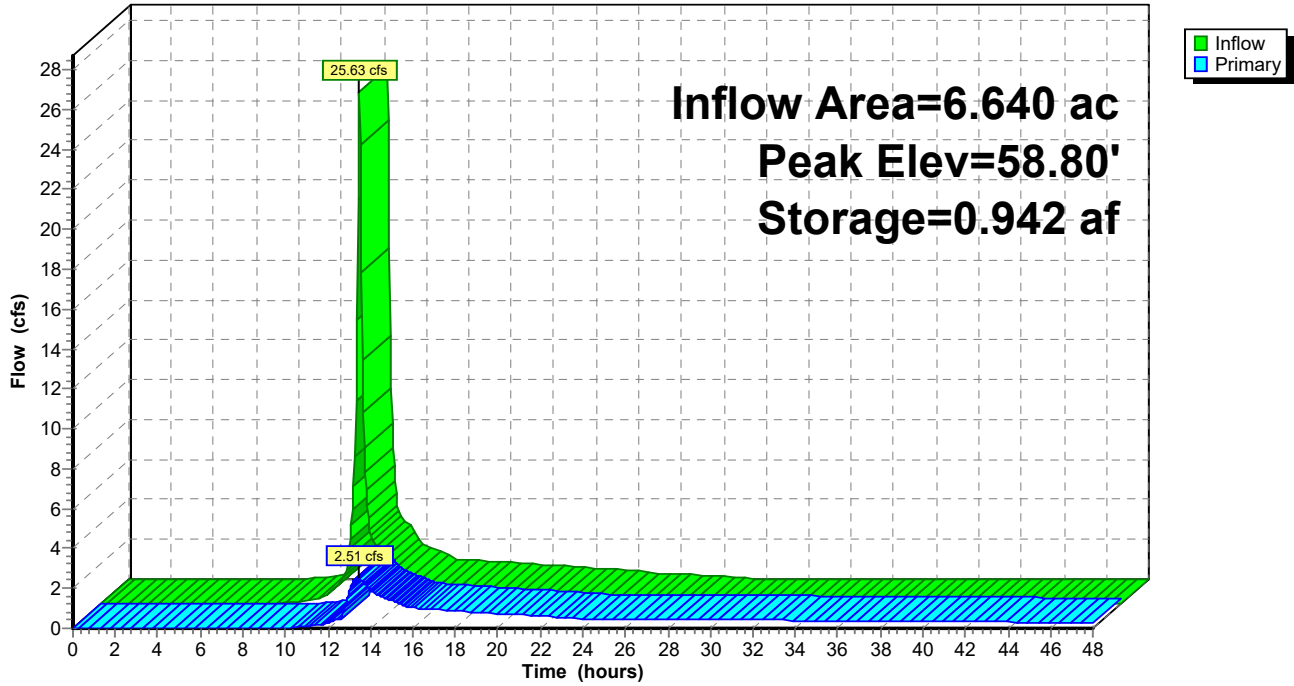

**Summary for Pond 45B: Infiltration Basin**

Inflow Area = 38.360 ac, 43.04% Impervious, Inflow Depth > 3.29" for 100 yr event  
 Inflow = 60.71 cfs @ 12.55 hrs, Volume= 10.516 af  
 Outflow = 22.39 cfs @ 13.52 hrs, Volume= 9.802 af, Atten= 63%, Lag= 57.8 min  
 Discarded = 0.11 cfs @ 13.52 hrs, Volume= 0.226 af  
 Primary = 22.28 cfs @ 13.52 hrs, Volume= 9.576 af

Routing by Dyn-Stor-Ind method, Time Span= 0.00-48.00 hrs, dt= 0.05 hrs  
 Peak Elev= 56.82' @ 13.52 hrs Surf.Area= 0.629 ac Storage= 2.287 af

Plug-Flow detention time= 168.2 min calculated for 9.791 af (93% of inflow)  
 Center-of-Mass det. time= 69.3 min ( 1,109.4 - 1,040.1 )

Volume	Invert	Avail.Storage	Storage Description	
#1	52.00'	3.070 af	<b>Custom Stage Data (Conic)</b> Listed below (Recalc)	
Elevation (feet)	Surf.Area (acres)	Inc.Store (acre-feet)	Cum.Store (acre-feet)	Wet.Area (acres)
52.00	0.310	0.000	0.000	0.310
54.00	0.450	0.756	0.756	0.452
55.00	0.520	0.485	1.240	0.523
56.00	0.580	0.550	1.790	0.584
57.00	0.640	0.610	2.400	0.645
58.00	0.700	0.670	3.070	0.707

Device	Routing	Invert	Outlet Devices
#1	Discarded	52.00'	<b>0.130 in/hr Exfiltration over Wetted area</b> Conductivity to Groundwater Elevation = 42.00' Phase-In= 0.01'
#2	Primary	52.00'	<b>24.0" Round Culvert</b> L= 205.0' RCP, square edge headwall, Ke= 0.500 Inlet / Outlet Invert= 52.00' / 51.00' S= 0.0049 '/' Cc= 0.900 n= 0.013, Flow Area= 3.14 sf
#3	Device 2	52.25'	<b>3.0" Vert. Orifice/Grate</b> C= 0.600
#4	Device 2	53.75'	<b>24.0" Vert. Orifice/Grate</b> C= 0.600

**Discarded OutFlow** Max=0.11 cfs @ 13.52 hrs HW=56.82' (Free Discharge)

↑ **1=Exfiltration** ( Controls 0.11 cfs)

**Primary OutFlow** Max=22.28 cfs @ 13.52 hrs HW=56.82' TW=0.00' (Dynamic Tailwater)

↑ **2=Culvert** (Passes 22.28 cfs of 24.48 cfs potential flow)

↑ **3=Orifice/Grate** (Orifice Controls 0.50 cfs @ 10.15 fps)

↑ **4=Orifice/Grate** (Orifice Controls 21.78 cfs @ 6.93 fps)

### Pond 45B: Infiltration Basin

Hydrograph

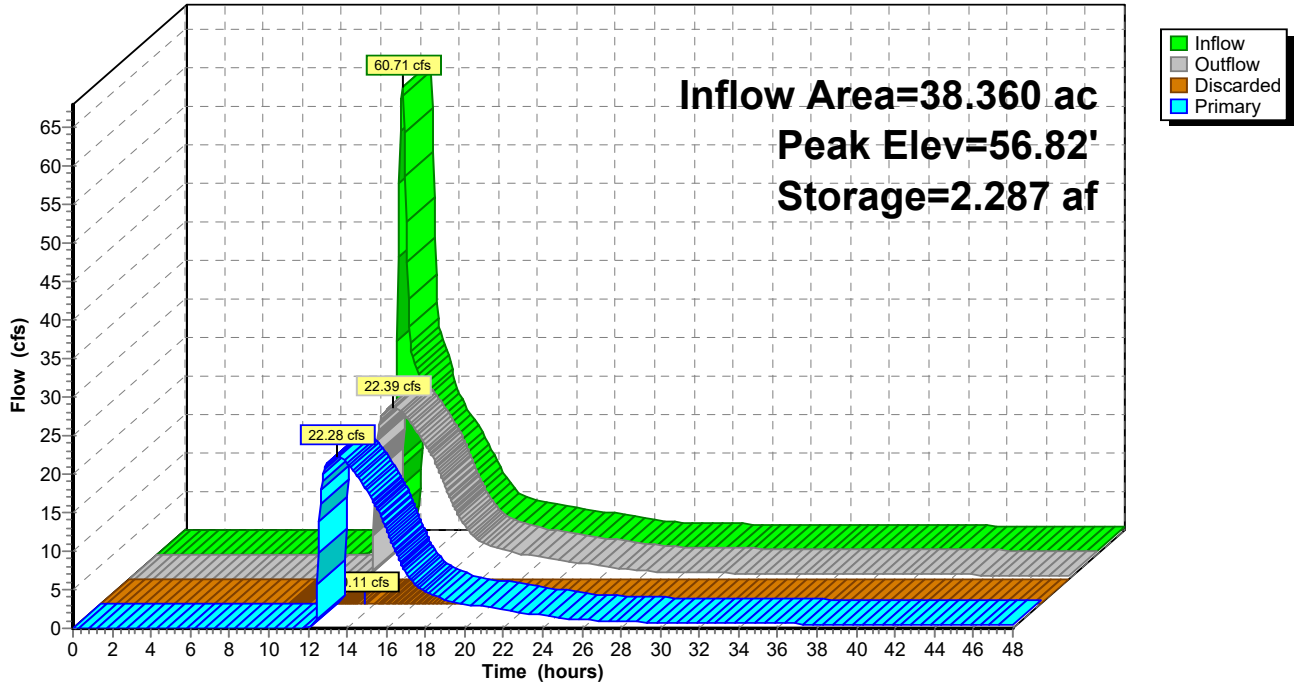

**Summary for Pond 70B: Dry Basin**

Inflow Area = 2.690 ac, 18.22% Impervious, Inflow Depth = 2.76" for 100 yr event  
 Inflow = 7.76 cfs @ 12.34 hrs, Volume= 0.619 af  
 Outflow = 1.00 cfs @ 13.47 hrs, Volume= 0.618 af, Atten= 87%, Lag= 67.7 min  
 Primary = 1.00 cfs @ 13.47 hrs, Volume= 0.618 af

Routing by Dyn-Stor-Ind method, Time Span= 0.00-48.00 hrs, dt= 0.05 hrs  
 Peak Elev= 65.62' @ 13.47 hrs Surf.Area= 0.218 ac Storage= 0.352 af

Plug-Flow detention time= 294.7 min calculated for 0.618 af (100% of inflow)  
 Center-of-Mass det. time= 295.0 min ( 1,123.7 - 828.7 )

Volume	Invert	Avail.Storage	Storage Description		
#1	63.50'	0.697 af	<b>Custom Stage Data (Conic)</b> Listed below (Recalc)		
Elevation (feet)	Surf.Area (acres)	Inc.Store (acre-feet)	Cum.Store (acre-feet)	Wet.Area (acres)	
63.50	0.030	0.000	0.000	0.030	
64.00	0.160	0.043	0.043	0.160	
65.00	0.200	0.180	0.223	0.201	
66.00	0.230	0.215	0.438	0.232	
67.00	0.290	0.259	0.697	0.292	

Device	Routing	Invert	Outlet Devices	
#1	Primary	63.00'	<b>12.0" Round Culvert</b> L= 75.0' RCP, square edge headwall, Ke= 0.500 Inlet / Outlet Invert= 63.00' / 62.25' S= 0.0100 '/' Cc= 0.900 n= 0.013, Flow Area= 0.79 sf	
#2	Device 1	63.50'	<b>4.0" Vert. Orifice/Grate</b> C= 0.600	
#3	Device 1	65.50'	<b>12.0" Horiz. Orifice/Grate</b> C= 0.600 Limited to weir flow at low heads	
#4	Primary	66.00'	<b>10.0' long x 10.0' breadth Broad-Crested Rectangular Weir</b> Head (feet) 0.20 0.40 0.60 0.80 1.00 1.20 1.40 1.60 Coef. (English) 2.49 2.56 2.70 2.69 2.68 2.69 2.67 2.64	

**Primary OutFlow** Max=1.00 cfs @ 13.47 hrs HW=65.62' TW=58.80' (Dynamic Tailwater)

- 1=Culvert (Passes 1.00 cfs of 4.94 cfs potential flow)
- 2=Orifice/Grate (Orifice Controls 0.59 cfs @ 6.72 fps)
- 3=Orifice/Grate (Weir Controls 0.41 cfs @ 1.12 fps)
- 4=Broad-Crested Rectangular Weir ( Controls 0.00 cfs)



### Pond 70B: Dry Basin

Hydrograph

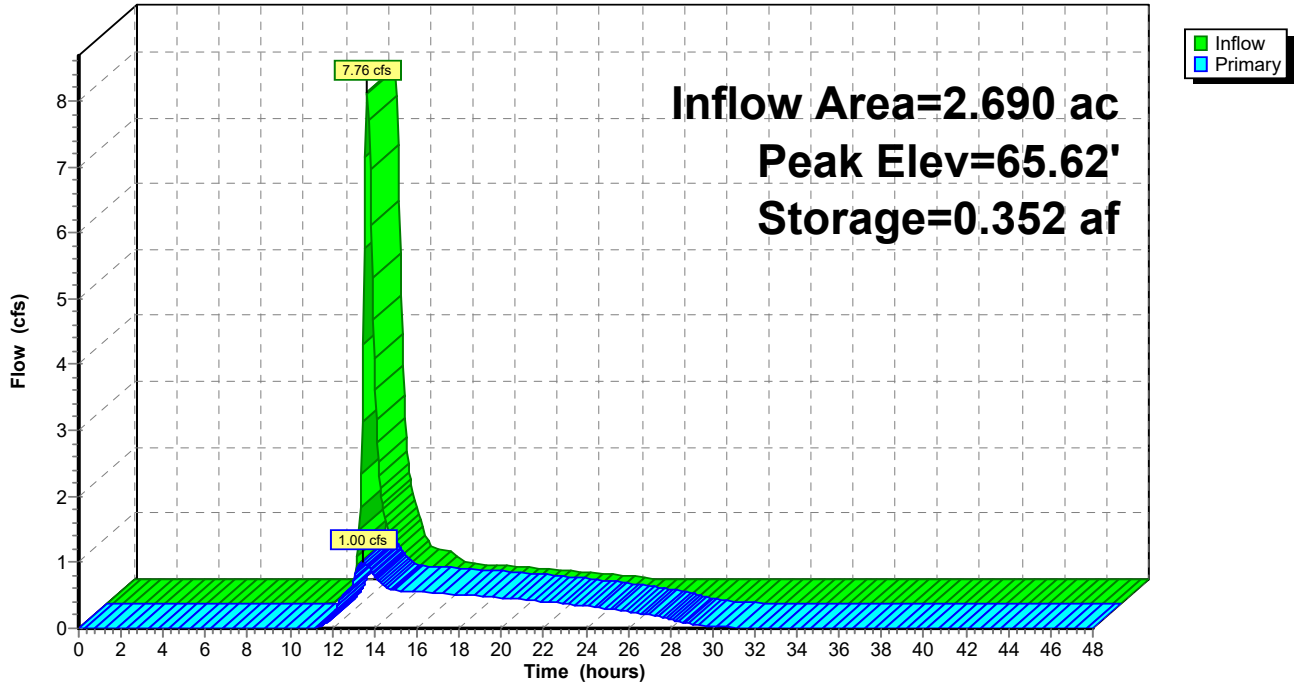

**Summary for Pond 80P: Pond**

Inflow Area = 9.660 ac, 43.89% Impervious, Inflow Depth = 3.64" for 100 yr event  
 Inflow = 31.77 cfs @ 12.42 hrs, Volume= 2.928 af  
 Outflow = 27.36 cfs @ 12.55 hrs, Volume= 2.923 af, Atten= 14%, Lag= 8.1 min  
 Primary = 27.36 cfs @ 12.55 hrs, Volume= 2.923 af

Routing by Dyn-Stor-Ind method, Time Span= 0.00-48.00 hrs, dt= 0.05 hrs  
 Peak Elev= 58.60' @ 12.55 hrs Surf.Area= 0.228 ac Storage= 0.543 af

Plug-Flow detention time= 96.5 min calculated for 2.923 af (100% of inflow)  
 Center-of-Mass det. time= 95.5 min ( 915.7 - 820.2 )

Volume	Invert	Avail.Storage	Storage Description
#1	55.50'	0.767 af	<b>Pond (Conic)</b> Listed below (Recalc)

Elevation (feet)	Surf.Area (acres)	Inc.Store (acre-feet)	Cum.Store (acre-feet)	Wet.Area (acres)
55.50	0.130	0.000	0.000	0.130
56.00	0.140	0.067	0.067	0.140
57.00	0.170	0.155	0.222	0.171
58.00	0.210	0.190	0.412	0.212
59.00	0.240	0.225	0.637	0.243
59.50	0.280	0.130	0.767	0.283

Device	Routing	Invert	Outlet Devices
#1	Primary	54.20'	<b>24.0" Round Culvert</b> L= 40.0' RCP, square edge headwall, Ke= 0.500 Inlet / Outlet Invert= 54.20' / 54.00' S= 0.0050 '/ Cc= 0.900 n= 0.013, Flow Area= 3.14 sf
#2	Device 1	55.50'	<b>4.0" Vert. Orifice/Grate</b> C= 0.600
#3	Device 1	57.33'	<b>30.0" Horiz. Orifice/Grate</b> C= 0.600 Limited to weir flow at low heads
#4	Primary	58.75'	<b>10.0' long x 10.0' breadth Broad-Crested Rectangular Weir</b> Head (feet) 0.20 0.40 0.60 0.80 1.00 1.20 1.40 1.60 Coef. (English) 2.49 2.56 2.70 2.69 2.68 2.69 2.67 2.64

**Primary OutFlow** Max=27.35 cfs @ 12.55 hrs HW=58.60' TW=0.00' (Dynamic Tailwater)

- 1=Culvert (Passes 27.35 cfs of 27.89 cfs potential flow)
- 2=Orifice/Grate (Orifice Controls 0.72 cfs @ 8.25 fps)
- 3=Orifice/Grate (Orifice Controls 26.63 cfs @ 5.43 fps)
- 4=Broad-Crested Rectangular Weir ( Controls 0.00 cfs)

### Pond 80P: Pond

Hydrograph

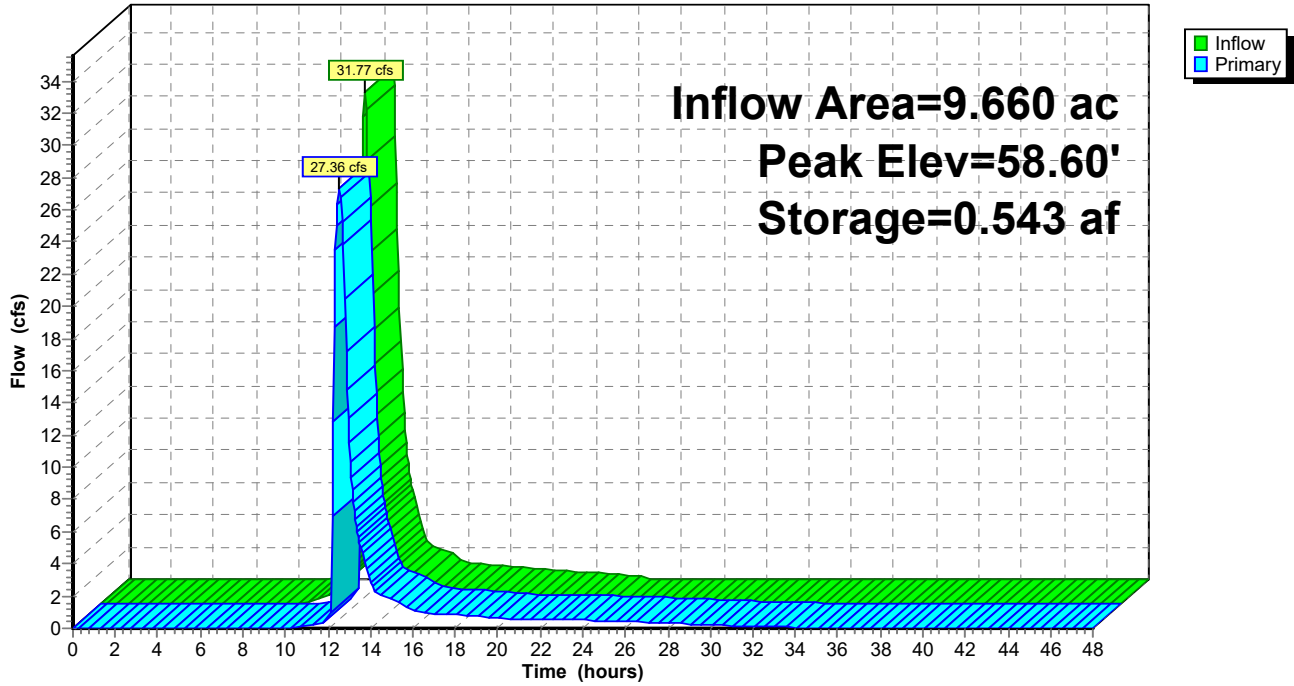

**Summary for Pond 90B: Rain Garden**

Inflow Area = 1.270 ac, 28.35% Impervious, Inflow Depth = 3.04" for 100 yr event  
 Inflow = 6.94 cfs @ 12.13 hrs, Volume= 0.322 af  
 Outflow = 3.47 cfs @ 12.24 hrs, Volume= 0.322 af, Atten= 50%, Lag= 6.5 min  
 Discarded = 0.01 cfs @ 12.24 hrs, Volume= 0.016 af  
 Primary = 3.45 cfs @ 12.24 hrs, Volume= 0.307 af

Routing by Dyn-Stor-Ind method, Time Span= 0.00-48.00 hrs, dt= 0.05 hrs  
 Peak Elev= 60.83' @ 12.24 hrs Surf.Area= 0.096 ac Storage= 0.091 af

Plug-Flow detention time= 44.1 min calculated for 0.322 af (100% of inflow)  
 Center-of-Mass det. time= 44.5 min ( 853.0 - 808.4 )

Volume	Invert	Avail.Storage	Storage Description			
#1	58.50'	0.232 af	<b>Custom Stage Data (Conic)</b> Listed below (Recalc)			
Elevation (feet)	Surf.Area (acres)	Voids (%)	Inc.Store (acre-feet)	Cum.Store (acre-feet)	Wet.Area (acres)	
58.50	0.060	0.0	0.000	0.000	0.060	
59.00	0.060	30.0	0.009	0.009	0.062	
60.00	0.060	30.0	0.018	0.027	0.066	
60.90	0.100	100.0	0.071	0.098	0.106	
61.90	0.170	100.0	0.133	0.232	0.177	

Device	Routing	Invert	Outlet Devices							
#1	Discarded	58.50'	<b>0.130 in/hr Exfiltration over Wetted area</b> Conductivity to Groundwater Elevation = 42.00' Phase-In= 0.01'							
#2	Primary	58.75'	<b>4.0" Vert. Orifice/Grate</b> C= 0.600							
#3	Primary	60.25'	<b>12.0" Horiz. Orifice/Grate</b> C= 0.600 Limited to weir flow at low heads							
#4	Primary	60.90'	<b>10.0' long x 10.0' breadth Broad-Crested Rectangular Weir</b> Head (feet) 0.20 0.40 0.60 0.80 1.00 1.20 1.40 1.60 Coef. (English) 2.49 2.56 2.70 2.69 2.68 2.69 2.67 2.64							

**Discarded OutFlow** Max=0.01 cfs @ 12.24 hrs HW=60.82' (Free Discharge)  
 ↑1=Exfiltration ( Controls 0.01 cfs)

**Primary OutFlow** Max=3.45 cfs @ 12.24 hrs HW=60.82' TW=0.00' (Dynamic Tailwater)  
 ↑2=Orifice/Grate (Orifice Controls 0.58 cfs @ 6.65 fps)  
 ↑3=Orifice/Grate (Orifice Controls 2.86 cfs @ 3.65 fps)  
 ↑4=Broad-Crested Rectangular Weir ( Controls 0.00 cfs)

### Pond 90B: Rain Garden

Hydrograph

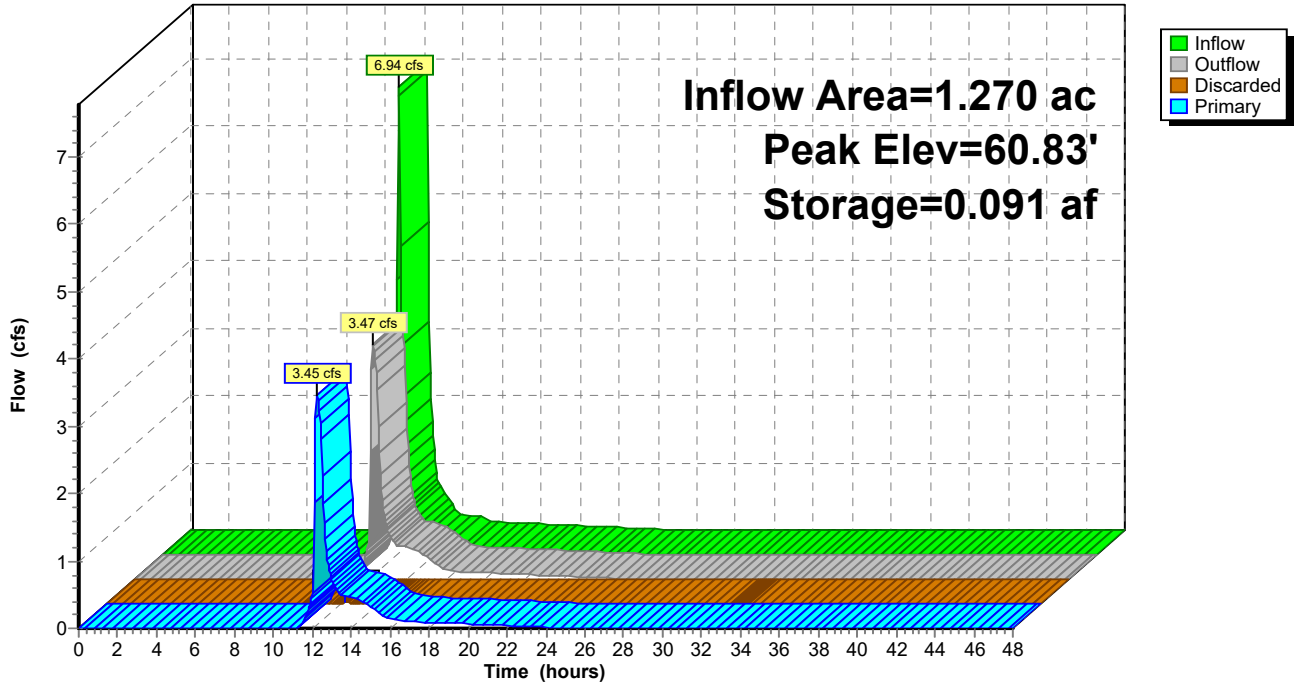

**Summary for Pond 100B: Rain Garden**

Inflow Area = 2.120 ac, 26.42% Impervious, Inflow Depth = 3.04" for 100 yr event  
 Inflow = 9.98 cfs @ 12.17 hrs, Volume= 0.538 af  
 Outflow = 4.23 cfs @ 12.36 hrs, Volume= 0.538 af, Atten= 58%, Lag= 11.2 min  
 Discarded = 0.02 cfs @ 12.36 hrs, Volume= 0.025 af  
 Primary = 4.20 cfs @ 12.36 hrs, Volume= 0.513 af

Routing by Dyn-Stor-Ind method, Time Span= 0.00-48.00 hrs, dt= 0.05 hrs  
 Peak Elev= 56.14' @ 12.36 hrs Surf.Area= 0.135 ac Storage= 0.169 af

Plug-Flow detention time= 54.2 min calculated for 0.538 af (100% of inflow)  
 Center-of-Mass det. time= 54.0 min ( 865.7 - 811.7 )

Volume	Invert	Avail.Storage	Storage Description		
#1	53.50'	0.494 af	<b>Custom Stage Data (Conic)</b> Listed below (Recalc)		
Elevation (feet)	Surf.Area (acres)	Voids (%)	Inc.Store (acre-feet)	Cum.Store (acre-feet)	Wet.Area (acres)
53.50	0.090	0.0	0.000	0.000	0.090
54.00	0.090	30.0	0.013	0.013	0.093
55.00	0.090	30.0	0.027	0.040	0.098
56.00	0.130	100.0	0.109	0.150	0.138
57.00	0.170	100.0	0.150	0.299	0.179
58.00	0.220	100.0	0.194	0.494	0.229

Device	Routing	Invert	Outlet Devices
#1	Discarded	53.50'	<b>0.130 in/hr Exfiltration over Wetted area</b> Conductivity to Groundwater Elevation = 42.00' Phase-In= 0.01'
#2	Primary	53.75'	<b>4.0" Vert. Orifice/Grate</b> C= 0.600
#3	Primary	55.25'	<b>12.0" Horiz. Orifice/Grate</b> C= 0.600 Limited to weir flow at low heads
#4	Primary	56.50'	<b>10.0' long x 10.0' breadth Broad-Crested Rectangular Weir</b> Head (feet) 0.20 0.40 0.60 0.80 1.00 1.20 1.40 1.60 Coef. (English) 2.49 2.56 2.70 2.69 2.68 2.69 2.67 2.64

**Discarded OutFlow** Max=0.02 cfs @ 12.36 hrs HW=56.14' (Free Discharge)  
 ↑1=Exfiltration ( Controls 0.02 cfs)

**Primary OutFlow** Max=4.20 cfs @ 12.36 hrs HW=56.14' TW=0.00' (Dynamic Tailwater)  
 ↑2=Orifice/Grate (Orifice Controls 0.63 cfs @ 7.18 fps)  
 ↑3=Orifice/Grate (Orifice Controls 3.57 cfs @ 4.55 fps)  
 ↑4=Broad-Crested Rectangular Weir( Controls 0.00 cfs)

### Pond 100B: Rain Garden

Hydrograph

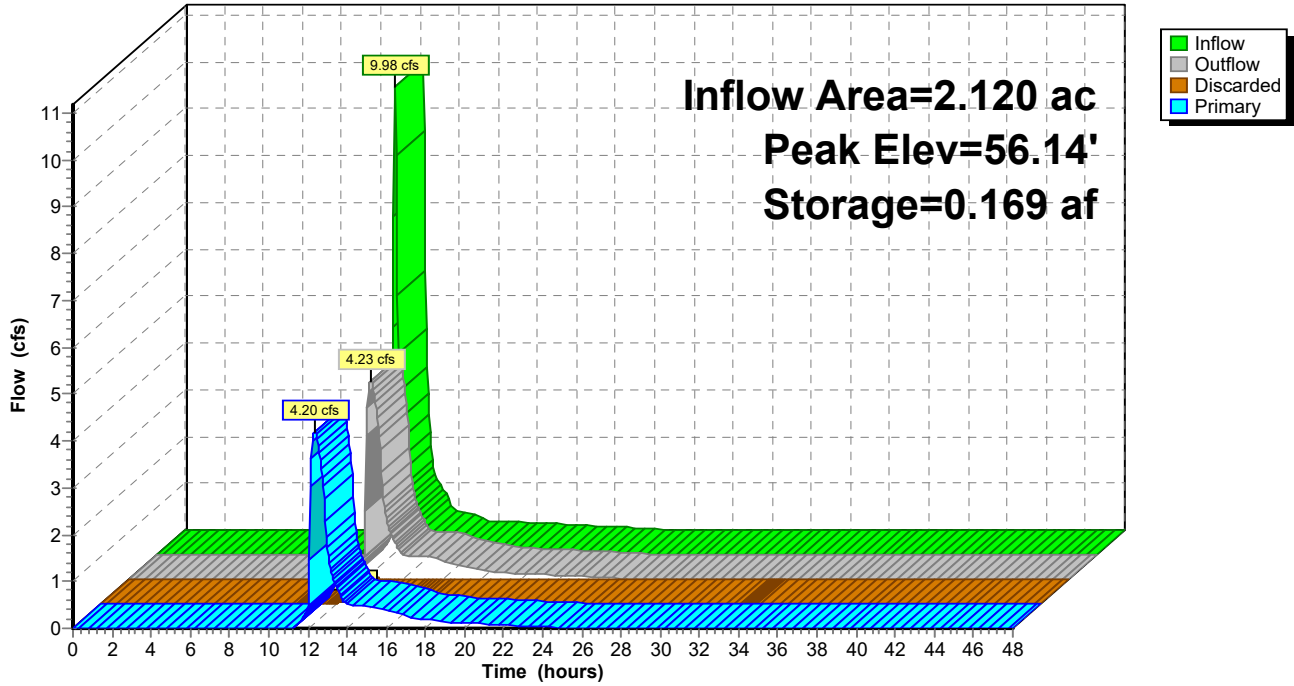

### Summary for Link 65L: West Development

Inflow Area = 44.320 ac, 39.89% Impervious, Inflow Depth > 2.97" for 100 yr event  
Inflow = 27.94 cfs @ 12.15 hrs, Volume= 10.957 af  
Primary = 27.94 cfs @ 12.15 hrs, Volume= 10.957 af, Atten= 0%, Lag= 0.0 min

Primary outflow = Inflow, Time Span= 0.00-48.00 hrs, dt= 0.05 hrs

### Link 65L: West Development

Hydrograph

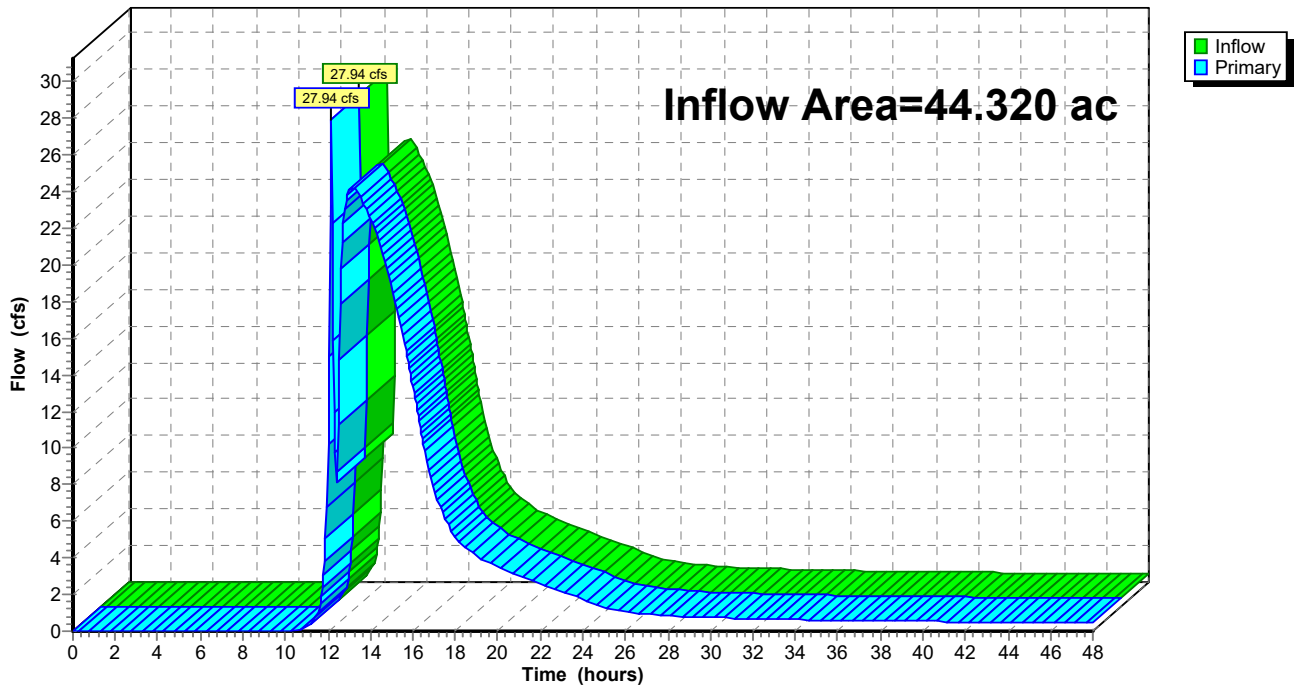



### Summary for Link 105L: East Development

Inflow Area = 13.050 ac, 39.54% Impervious, Inflow Depth = 3.44" for 100 yr event  
Inflow = 33.35 cfs @ 12.49 hrs, Volume= 3.743 af  
Primary = 33.35 cfs @ 12.49 hrs, Volume= 3.743 af, Atten= 0%, Lag= 0.0 min

Primary outflow = Inflow, Time Span= 0.00-48.00 hrs, dt= 0.05 hrs

### Link 105L: East Development

Hydrograph

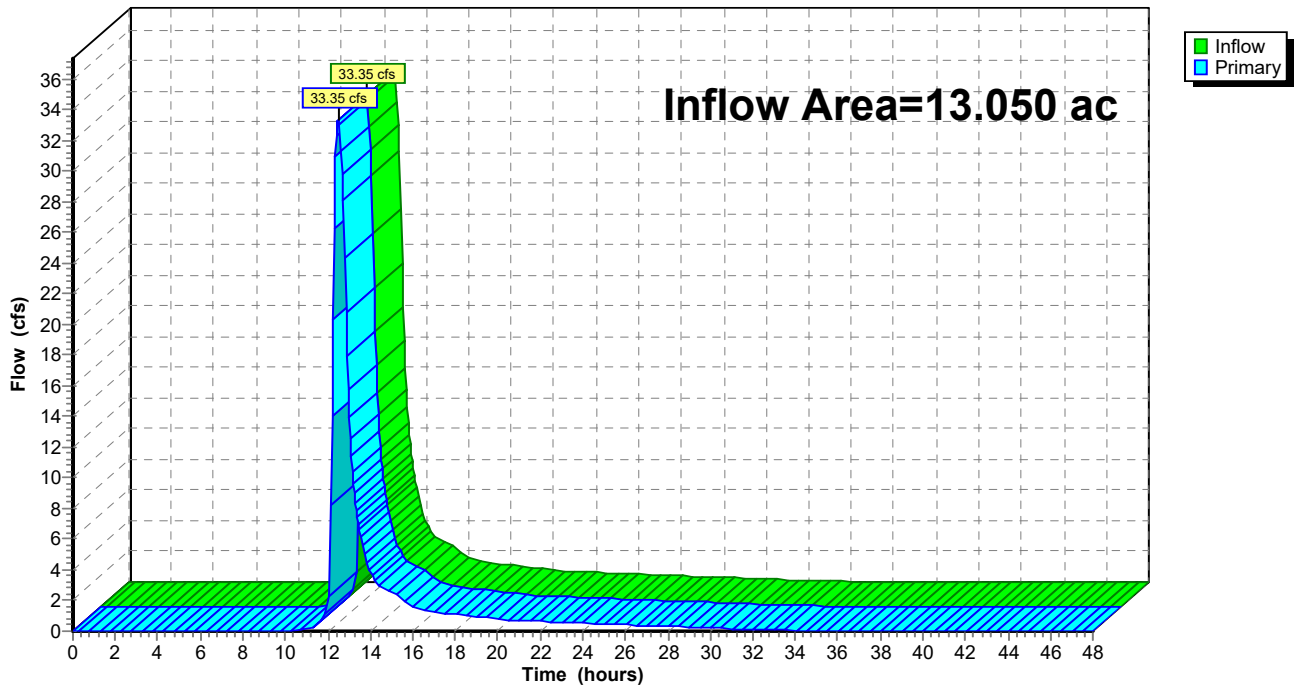

### Summary for Link 110L: Post-Development Outflow

Inflow Area = 57.370 ac, 39.81% Impervious, Inflow Depth > 3.07" for 100 yr event  
Inflow = 51.18 cfs @ 12.67 hrs, Volume= 14.700 af  
Primary = 51.18 cfs @ 12.67 hrs, Volume= 14.700 af, Atten= 0%, Lag= 0.0 min

Primary outflow = Inflow, Time Span= 0.00-48.00 hrs, dt= 0.05 hrs

### Link 110L: Post-Development Outflow

Hydrograph

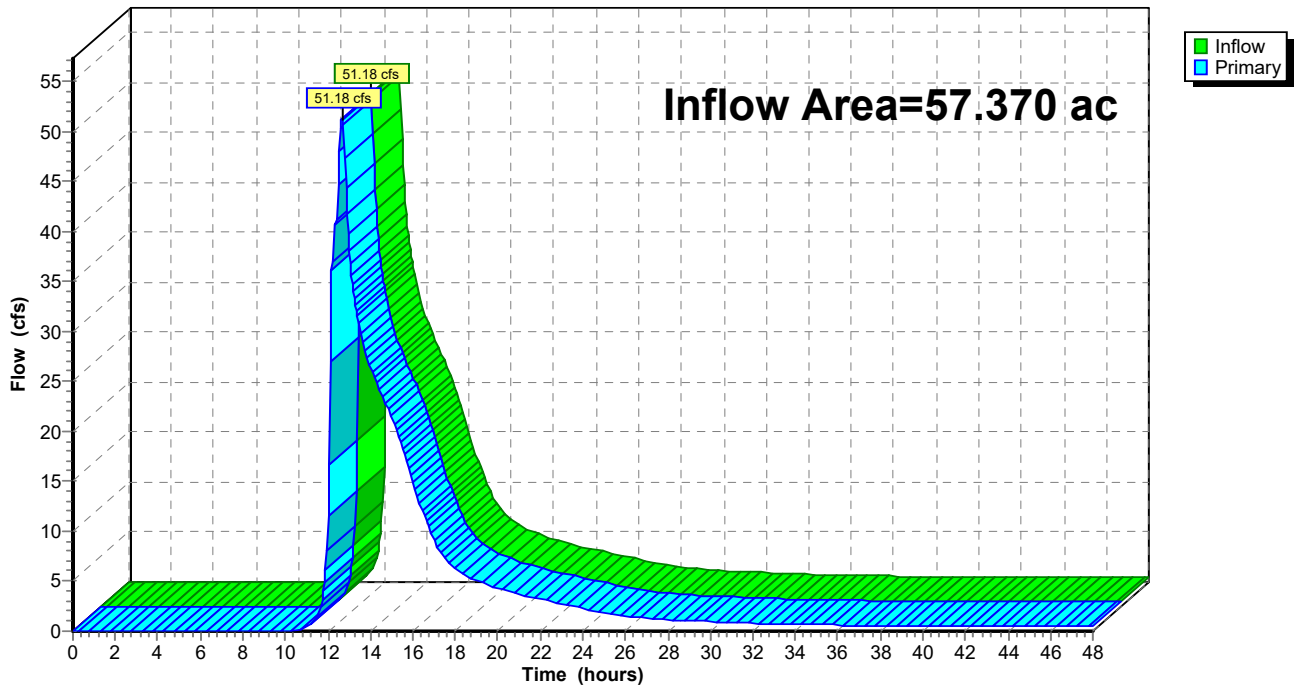

# APPENDIX C

## WinSLAMM Treatment Analysis

# WinSLAMM Analysis

WinSLAMM v 10 Data File: [D:\Jobs\2020\2020-012\_Standing Stone - TRIO\Project\_Information\Calcs\SLAMM\Proposed\_Disconnected\_2020-012.mdb] - [Land Use Model]

File Current File Data Pollutants Tools Run Utilities Help



Control Practice:



Land Use #	Land Use Type	Land Use Label	Land Use Area (acres)
1	Residential	Subarea 10	5.430
2	Residential	Subarea 20	6.860
3	Residential	Subarea 30	17.030
4	Residential	Subarea 40	3.950
5	Residential	Subarea 45	2.400
6	Residential	Subarea 50	0.780
7	Residential	Subarea 60	0.390
8	Residential	Subarea 70	2.690
9	Residential	Subarea 80	9.660
10	Residential	Subarea 90	1.270
11	Residential	Subarea 100	2.120

CP #	Control Practice Type	Control Practice Name or Location
1	Wet Detention Pond	Future Pond 10
2	Wet Detention Pond	Pond 20
3	Wet Detention Pond	Pond 30
4	Wet Detention Pond	Pond 40
5	Biofilter	Infiltration Basin 45
6	Catchbasin Cleaning	SA Device, LU# 6 ,SA# 37
7	Wet Detention Pond	Dry Pond 70
8	Wet Detention Pond	Pond 80
9	Biofilter	Bio 90
10	Biofilter	Bio 100

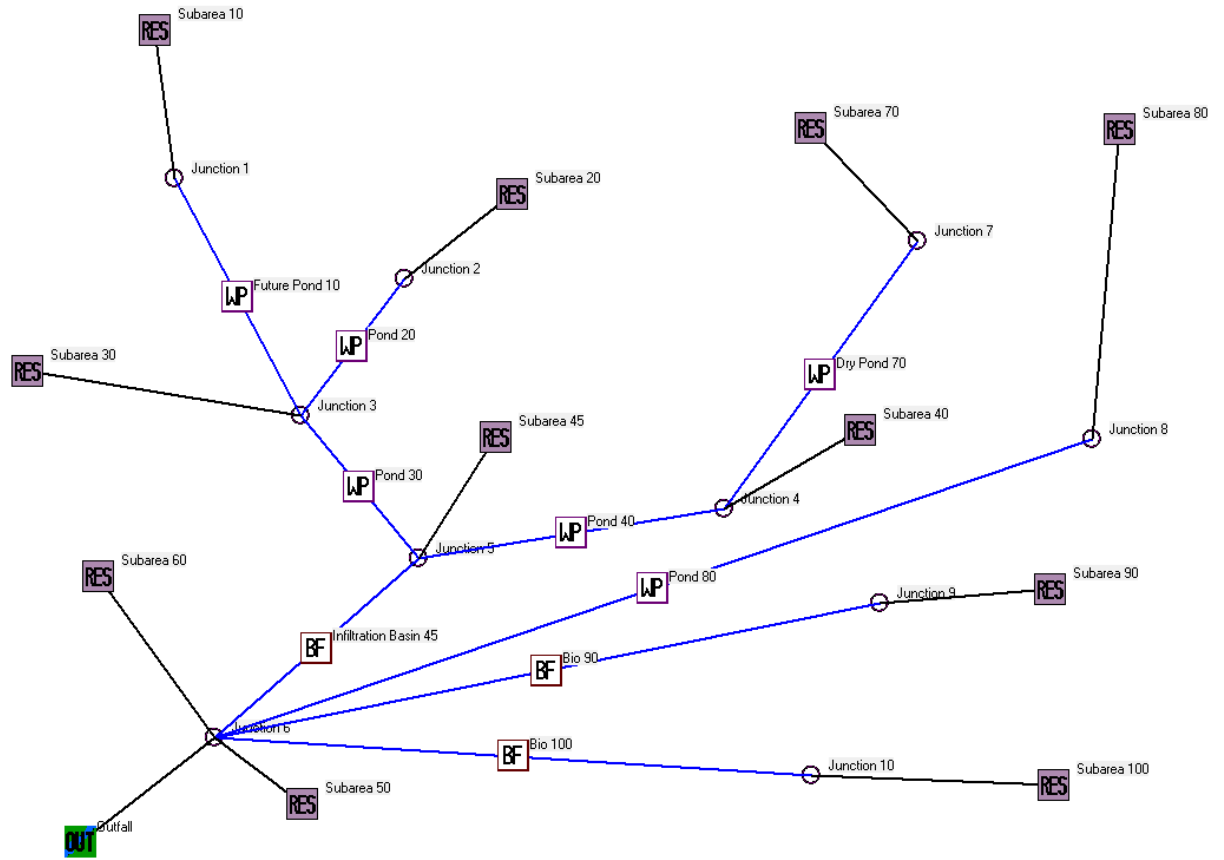

SLAMM for Windows Version 10.4.1

(c) Copyright Robert Pitt and John Voorhees 2019, All Rights Reserved

Data file name: D:\Jobs\2020\2020-012\_Standing Stone -

TRIO\Project\_Information\Calcs\SLAMM\Proposed\_Disconnected\_2020-012.mdb

Data file description:

Rain file name: C:\WinSLAMM Files\Rain Files\WisReg - Milwaukee WI 1969.RAN

Particulate Solids Concentration file name: C:\WinSLAMM Files\v10.1 WI\_AVG01.pscx

Runoff Coefficient file name: C:\WinSLAMM Files\WI\_SL06 Dec06.rsvx

Pollutant Relative Concentration file name: C:\WinSLAMM Files\WI\_GEO03.ppdX

Residential Street Delivery file name: C:\WinSLAMM Files\WI\_Res and Other Urban Dec06.std

Institutional Street Delivery file name: C:\WinSLAMM Files\WI\_Com Inst Indust Dec06.std

Commercial Street Delivery file name: C:\WinSLAMM Files\WI\_Com Inst Indust Dec06.std

Industrial Street Delivery file name: C:\WinSLAMM Files\WI\_Com Inst Indust Dec06.std

Other Urban Street Delivery file name: C:\WinSLAMM Files\WI\_Res and Other Urban Dec06.std

Freeway Street Delivery file name: C:\WinSLAMM Files\Freeway Dec06.std

Apply Street Delivery Files to Adjust the After Event Load Street Dirt Mass Balance: False

Source Area PSD and Peak to Average Flow Ratio File: C:\WinSLAMM Files\NURP Source Area PSD Files.csv

Cost Data file name:

If Other Device Pollutant Load Reduction Values = 1, Off-site Pollutant Loads are Removed from Pollutant Load % Reduction calculations

Seed for random number generator: -42

Start of Winter Season: 12/06 End of Winter Season: 03/28

Model Run Start Date: 01/05/69 Model Run End Date: 12/31/69

Date of run: 11-11-2020 Time of run: 20:51:48

Total Area Modeled (acres): 52.580

Years in Model Run: 0.99

	Runoff Volume (cu ft)	Percent Runoff Volume Reduction	Particulate Solids Conc. (mg/L)	Particulate Solids Yield (lbs)	Percent Particulate Solids Reduction
Total of all Land Uses without Controls:	2.087E+06	-	99.59	12976	-
Outfall Total with Controls:	1.569E+06	24.82%	26.42	2588	80.06%
Annualized Total After Outfall Controls:	1.591E+06			2624	

Data file name: D:\Jobs\2020\2020-012\_Standing Stone -  
 TRIO\Project\_Information\Calcs\SLAMM\Proposed\_Disconnected\_2020-012.mdb  
 WinSLAMM Version 10.4.1  
 Rain file name: C:\WinSLAMM Files\Rain Files\WisReg - Milwaukee WI 1969.RAN  
 Particulate Solids Concentration file name: C:\WinSLAMM Files\v10.1 WI\_AVG01.pscx  
 Runoff Coefficient file name: C:\WinSLAMM Files\WI\_SL06 Dec06.rsvx  
 Residential Street Delivery file name: C:\WinSLAMM Files\WI\_Res and Other Urban Dec06.std  
 Institutional Street Delivery file name: C:\WinSLAMM Files\WI\_Com Inst Indust Dec06.std  
 Commercial Street Delivery file name: C:\WinSLAMM Files\WI\_Com Inst Indust Dec06.std  
 Industrial Street Delivery file name: C:\WinSLAMM Files\WI\_Com Inst Indust Dec06.std  
 Other Urban Street Delivery file name: C:\WinSLAMM Files\WI\_Res and Other Urban Dec06.std  
 Freeway Street Delivery file name: C:\WinSLAMM Files\Freeway Dec06.std  
 Apply Street Delivery Files to Adjust the After Event Load Street Dirt Mass Balance: False  
 Pollutant Relative Concentration file name: C:\WinSLAMM Files\WI\_GEO03.ppdx  
 Source Area PSD and Peak to Average Flow Ratio File: C:\WinSLAMM Files\NURP Source Area PSD Files.csv  
 Cost Data file name:  
 If Other Device Pollutant Load Reduction Values = 1, Off-site Pollutant Loads are Removed from Pollutant Load  
 % Reduction calculations  
 Seed for random number generator: -42  
 Study period starting date: 01/05/69                      Study period ending date: 12/31/69  
 Start of Winter Season: 12/06                              End of Winter Season: 03/28  
 Date: 11-11-2020    Time: 20:51:56  
 Site information:

LU# 1 - Residential: Subarea 10                      Total area (ac): 5.430  
     1 - Roofs 1: 1.160 ac.                      Pitched                      Connected                      Source Area PSD File: C:\WinSLAMM Files\NURP.cpz  
     13 - Paved Parking 1: 0.970 ac.                      Connected                      Source Area PSD File: C:\WinSLAMM Files\NURP.cpz  
     45 - Large Landscaped Areas 1: 3.170 ac.                      Normal Silty                      Source Area PSD File: C:\WinSLAMM  
 Files\NURP.cpz  
     70 - Water Body Areas: 0.130 ac.                      Source Area PSD File:

LU# 2 - Residential: Subarea 20                      Total area (ac): 6.860  
     1 - Roofs 1: 0.650 ac.                      Pitched                      Connected                      Source Area PSD File: C:\WinSLAMM Files\NURP.cpz  
     25 - Driveways 1: 0.270 ac.                      Connected                      Source Area PSD File: C:\WinSLAMM Files\NURP.cpz  
     31 - Sidewalks 1: 0.740 ac.                      Connected                      Source Area PSD File: C:\WinSLAMM Files\NURP.cpz  
     37 - Streets 1: 1.010 ac.                      Smooth                      Street Length = 0.427 curb-mi                      Street Width (assuming two curb-  
 mi per street mile) = 39.0281 ft  
     Default St. Dirt Accum.                      Annual Winter Load = 2500 lbs                      Source Area PSD File: C:\WinSLAMM  
 Files\NURP.cpz

45 - Large Landscaped Areas 1: 3.850 ac. Normal Silty Source Area PSD File: C:\WinSLAMM  
 Files\NURP.cpz  
 69 - Isolated Areas: 0.020 ac. Source Area PSD File:  
 70 - Water Body Areas: 0.320 ac. Source Area PSD File:  
 LU# 3 - Residential: Subarea 30 Total area (ac): 17.030  
 1 - Roofs 1: 2.250 ac. Pitched Connected Source Area PSD File: C:\WinSLAMM Files\NURP.cpz  
 2 - Roofs 2: 0.880 ac. Pitched Connected Source Area PSD File: C:\WinSLAMM Files\NURP.cpz  
 25 - Driveways 1: 1.610 ac. Connected Source Area PSD File: C:\WinSLAMM Files\NURP.cpz  
 26 - Driveways 2: 0.240 ac. Connected Source Area PSD File: C:\WinSLAMM Files\NURP.cpz  
 31 - Sidewalks 1: 0.430 ac. Connected Source Area PSD File: C:\WinSLAMM Files\NURP.cpz  
 32 - Sidewalks 2: 0.330 ac. Connected Source Area PSD File: C:\WinSLAMM Files\NURP.cpz  
 37 - Streets 1: 1.310 ac. Smooth Street Length = 0.554 curb-mi Street Width (assuming two curb-  
 mi per street mile) = 39.01624 ft  
 Default St. Dirt Accum. Annual Winter Load = 2500 lbs Source Area PSD File: C:\WinSLAMM  
 Files\NURP.cpz  
 38 - Streets 2: 0.730 ac. Smooth Street Length = 0.309 curb-mi Street Width (assuming two curb-  
 mi per street mile) = 38.98059 ft  
 Default St. Dirt Accum. Annual Winter Load = 2500 lbs Source Area PSD File: C:\WinSLAMM  
 Files\NURP.cpz  
 45 - Large Landscaped Areas 1: 8.850 ac. Normal Silty Source Area PSD File: C:\WinSLAMM  
 Files\NURP.cpz  
 70 - Water Body Areas: 0.400 ac. Source Area PSD File:  
 LU# 4 - Residential: Subarea 40 Total area (ac): 3.950  
 1 - Roofs 1: 0.470 ac. Pitched Connected Source Area PSD File: C:\WinSLAMM Files\NURP.cpz  
 25 - Driveways 1: 0.310 ac. Connected Source Area PSD File: C:\WinSLAMM Files\NURP.cpz  
 31 - Sidewalks 1: 0.300 ac. Connected Source Area PSD File: C:\WinSLAMM Files\NURP.cpz  
 37 - Streets 1: 0.930 ac. Smooth Street Length = 0.393 curb-mi Street Width (assuming two curb-  
 mi per street mile) = 39.0458 ft  
 Default St. Dirt Accum. Annual Winter Load = 2500 lbs Source Area PSD File: C:\WinSLAMM  
 Files\NURP.cpz  
 45 - Large Landscaped Areas 1: 1.800 ac. Normal Silty Source Area PSD File: C:\WinSLAMM  
 Files\NURP.cpz  
 70 - Water Body Areas: 0.140 ac. Source Area PSD File:  
 LU# 5 - Residential: Subarea 45 Total area (ac): 2.400  
 1 - Roofs 1: 0.310 ac. Pitched Connected Source Area PSD File: C:\WinSLAMM Files\NURP.cpz  
 31 - Sidewalks 1: 0.110 ac. Connected Source Area PSD File: C:\WinSLAMM Files\NURP.cpz  
 45 - Large Landscaped Areas 1: 1.980 ac. Normal Silty Source Area PSD File: C:\WinSLAMM  
 Files\NURP.cpz

LU# 6 - Residential: Subarea 50 Total area (ac): 0.780  
 1 - Roofs 1: 0.060 ac. Pitched Disconnected Normal Silty Source Area PSD File: C:\WinSLAMM  
 Files\NURP.cpz  
 25 - Driveways 1: 0.020 ac. Disconnected Normal Silty Source Area PSD File: C:\WinSLAMM  
 Files\NURP.cpz  
 31 - Sidewalks 1: 0.040 ac. Disconnected Normal Silty Source Area PSD File: C:\WinSLAMM  
 Files\NURP.cpz  
 32 - Sidewalks 2: 0.130 ac. Connected Source Area PSD File: C:\WinSLAMM Files\NURP.cpz  
 37 - Streets 1: 0.530 ac. Smooth Street Length = 0.224 curb-mi Street Width (assuming two curb-  
 mi per street mile) = 39.04018 ft  
 Default St. Dirt Accum. Annual Winter Load = 2500 lbs Source Area PSD File: C:\WinSLAMM  
 Files\NURP.cpz CB-CP#6  
 LU# 7 - Residential: Subarea 60 Total area (ac): 0.390  
 1 - Roofs 1: 0.200 ac. Pitched Disconnected Normal Silty Source Area PSD File: C:\WinSLAMM  
 Files\NURP.cpz  
 31 - Sidewalks 1: 0.190 ac. Disconnected Normal Silty Source Area PSD File: C:\WinSLAMM  
 Files\NURP.cpz  
 LU# 8 - Residential: Subarea 70 Total area (ac): 2.690  
 1 - Roofs 1: 0.480 ac. Pitched Disconnected Normal Silty Source Area PSD File: C:\WinSLAMM  
 Files\NURP.cpz  
 31 - Sidewalks 1: 0.010 ac. Disconnected Normal Silty Source Area PSD File: C:\WinSLAMM  
 Files\NURP.cpz  
 45 - Large Landscaped Areas 1: 2.200 ac. Normal Silty Source Area PSD File: C:\WinSLAMM  
 Files\NURP.cpz  
 LU# 9 - Residential: Subarea 80 Total area (ac): 9.660  
 1 - Roofs 1: 0.720 ac. Pitched Connected Source Area PSD File: C:\WinSLAMM Files\NURP.cpz  
 2 - Roofs 2: 0.310 ac. Pitched Connected Source Area PSD File: C:\WinSLAMM Files\NURP.cpz  
 25 - Driveways 1: 1.430 ac. Connected Source Area PSD File: C:\WinSLAMM Files\NURP.cpz  
 31 - Sidewalks 1: 0.370 ac. Connected Source Area PSD File: C:\WinSLAMM Files\NURP.cpz  
 37 - Streets 1: 1.280 ac. Smooth Street Length = 0.542 curb-mi Street Width (assuming two curb-  
 mi per street mile) = 38.96679 ft  
 Default St. Dirt Accum. Annual Winter Load = 2500 lbs Source Area PSD File: C:\WinSLAMM  
 Files\NURP.cpz  
 45 - Large Landscaped Areas 1: 5.420 ac. Normal Silty Source Area PSD File: C:\WinSLAMM  
 Files\NURP.cpz  
 70 - Water Body Areas: 0.130 ac. Source Area PSD File:  
 LU# 10 - Residential: Subarea 90 Total area (ac): 1.270  
 1 - Roofs 1: 0.360 ac. Pitched Connected Source Area PSD File: C:\WinSLAMM Files\NURP.cpz



45 - Large Landscaped Areas 1: 0.910 ac. Normal Silty Source Area PSD File: C:\WinSLAMM Files\NURP.cpz  
 LU# 11 - Residential: Subarea 100 Total area (ac): 2.120  
 1 - Roofs 1: 0.560 ac. Pitched Connected Source Area PSD File: C:\WinSLAMM Files\NURP.cpz  
 45 - Large Landscaped Areas 1: 1.560 ac. Normal Silty Source Area PSD File: C:\WinSLAMM Files\NURP.cpz

Control Practice 1: Wet Detention Pond CP# 1 (DS) - Future Pond 10  
 Particle Size Distribution file name: Not needed - calculated by program  
 Initial stage elevation (ft): 5  
 Peak to Average Flow Ratio: 3.8  
 Maximum flow allowed into pond (cfs): No maximum value entered

Outlet Characteristics:

- Outlet type: Orifice 1
  - 1. Orifice diameter (ft): 0.25
  - 2. Number of orifices: 1
  - 3. Invert elevation above datum (ft): 5
- Outlet type: Orifice 2
  - 1. Orifice diameter (ft): 0.92
  - 2. Number of orifices: 1
  - 3. Invert elevation above datum (ft): 6.25
- Outlet type: Broad Crested Weir
  - 1. Weir crest length (ft): 10
  - 2. Weir crest width (ft): 10
  - 3. Height from datum to bottom of weir opening: 9

Pond stage and surface area

Entry Number	Stage (ft)	Pond Area (acres)	Natural Seepage (in/hr)	Other Outflow (cfs)
0	0.00	0.0000	0.00	0.00
1	0.01	0.0200	0.00	0.00
2	1.00	0.0300	0.00	0.00
3	3.00	0.0500	0.00	0.00
4	4.00	0.0700	0.00	0.00
5	5.00	0.1300	0.00	0.00
6	7.00	0.1800	0.00	0.00
7	9.00	0.2400	0.00	0.00
8	10.00	0.2800	0.00	0.00

Control Practice 2: Wet Detention Pond CP# 2 (DS) - Pond 20

Particle Size Distribution file name: Not needed - calculated by program

Initial stage elevation (ft): 8

Peak to Average Flow Ratio: 3.8

Maximum flow allowed into pond (cfs): No maximum value entered

Outlet Characteristics:

Outlet type: Orifice 1

1. Orifice diameter (ft): 0.25
2. Number of orifices: 1
3. Invert elevation above datum (ft): 8

Outlet type: Broad Crested Weir

1. Weir crest length (ft): 10
2. Weir crest width (ft): 10
3. Height from datum to bottom of weir opening: 10

Outlet type: Vertical Stand Pipe

1. Stand pipe diameter (ft): 1.5
2. Stand pipe height above datum (ft): 8.75

Pond stage and surface area

Entry Number	Stage (ft)	Pond Area (acres)	Natural Seepage (in/hr)	Other Outflow (cfs)
0	0.00	0.0000	0.00	0.00
1	0.01	0.0800	0.00	0.00
2	1.00	0.1000	0.00	0.00
3	2.00	0.1200	0.00	0.00
4	3.00	0.1400	0.00	0.00
5	4.00	0.1500	0.00	0.00
6	5.00	0.1700	0.00	0.00
7	6.00	0.1900	0.00	0.00
8	7.00	0.2100	0.00	0.00
9	8.00	0.3200	0.00	0.00
10	9.00	0.4900	0.00	0.00
11	10.00	0.6100	0.00	0.00
12	11.00	0.7300	0.00	0.00
13	12.00	0.8700	0.00	0.00

Control Practice 3: Wet Detention Pond CP# 3 (DS) - Pond 30

Particle Size Distribution file name: Not needed - calculated by program

Initial stage elevation (ft): 6

Peak to Average Flow Ratio: 3.8  
Maximum flow allowed into pond (cfs): No maximum value entered

Outlet Characteristics:

Outlet type: Orifice 1

1. Orifice diameter (ft): 0.25
2. Number of orifices: 1
3. Invert elevation above datum (ft): 6

Outlet type: Broad Crested Weir

1. Weir crest length (ft): 10
2. Weir crest width (ft): 10
3. Height from datum to bottom of weir opening: 8

Pond stage and surface area

Entry Number	Stage (ft)	Pond Area (acres)	Natural Seepage (in/hr)	Other Outflow (cfs)
0	0.00	0.0000	0.00	0.00
1	0.01	0.1100	0.00	0.00
2	1.00	0.1300	0.00	0.00
3	2.00	0.1600	0.00	0.00
4	3.00	0.1800	0.00	0.00
5	4.00	0.2100	0.00	0.00
6	5.00	0.2500	0.00	0.00
7	6.00	0.4000	0.00	0.00
8	7.00	0.4700	0.00	0.00
9	8.00	0.5300	0.00	0.00
10	9.00	0.6200	0.00	0.00
11	10.00	0.7100	0.00	0.00
12	11.00	0.8300	0.00	0.00

Control Practice 4: Wet Detention Pond CP# 4 (DS) - Pond 40

Particle Size Distribution file name: Not needed - calculated by program

Initial stage elevation (ft): 5

Peak to Average Flow Ratio: 3.8

Maximum flow allowed into pond (cfs): No maximum value entered

Outlet Characteristics:

Outlet type: Orifice 1

1. Orifice diameter (ft): 0.25
2. Number of orifices: 1
3. Invert elevation above datum (ft): 5

Outlet type: Broad Crested Weir

1. Weir crest length (ft): 10
2. Weir crest width (ft): 10
3. Height from datum to bottom of weir opening: 8.6

Pond stage and surface area

Entry Number	Stage (ft)	Pond Area (acres)	Natural Seepage (in/hr)	Other Outflow (cfs)
0	0.00	0.0000	0.00	0.00
1	0.01	0.0100	0.00	0.00
2	1.00	0.0200	0.00	0.00
3	2.00	0.0250	0.00	0.00
4	3.00	0.0300	0.00	0.00
5	4.00	0.0500	0.00	0.00
6	5.00	0.1300	0.00	0.00
7	6.00	0.1800	0.00	0.00
8	7.00	0.2500	0.00	0.00
9	8.00	0.3300	0.00	0.00
10	9.00	0.4000	0.00	0.00
11	10.00	0.4900	0.00	0.00

Control Practice 5: Biofilter CP# 1 (DS) - Infiltration Basin 45

1. Top area (square feet) = 30500
2. Bottom area (square feet) = 13453
3. Depth (ft): 6
4. Biofilter width (ft) - for Cost Purposes Only: 10
5. Infiltration rate (in/hr) = 0.13
6. Random infiltration rate generation? No
7. Infiltration rate fraction (side): 1
8. Infiltration rate fraction (bottom): 1
9. Depth of biofilter that is rock filled (ft) 0
10. Porosity of rock filled volume = 0
11. Engineered soil infiltration rate: 0
12. Engineered soil depth (ft) = 0
13. Engineered soil porosity = 0
14. Percent solids reduction due to flow through engineered soil = 0
15. Biofilter peak to average flow ratio = 3.8
16. Number of biofiltration control devices = 1
17. Particle size distribution file: Not needed - calculated by program

18. Initial water surface elevation (ft): 0  
Soil Data                                  Soil Type Fraction in Eng. Soil  
Biofilter Outlet/Discharge Characteristics:

Outlet type: Broad Crested Weir  
    1. Weir crest length (ft): 10  
    2. Weir crest width (ft): 10  
    3. Height of datum to bottom of weir opening: 5  
Outlet type: Surface Discharge Pipe  
    1. Surface discharge pipe outlet diameter (ft): 0.25  
    2. Pipe invert elevation above datum (ft): 0.25  
    3. Number of surface pipe outlets: 1

Outlet type: Other Outlet

Stage Number	Stage (ft)	Discharge Rate (cfs)
2	1.00	0.000
3	2.00	0.390
4	3.00	7.860
5	4.00	16.910
6	5.00	22.690
7	6.00	27.270

Control Practice 6: Catchbasin Cleaning CP# 1 (SA) - SA Device, LU# 6 ,SA# 37

1. Fraction of area served by catchbasins = 1.00
2. Number of catchbasins = 2
3. Average sump depth below catchbasin outlet invert (feet) = 3
4. Depth of sediment in catchbasin sump at beginning of study period (ft) = 0
5. Typical outlet pipe diameter (ft) = 1
6. Typical outlet pipe Mannings n = 0.013
7. Typical outlet pipe slope (ft/ft) = 0.02
8. Typical catchbasin sump surface area (square feet) = 16
9. Total catchbasin depth (feet) = 8
10. Inflow hydrograph peak to average flow ratio = 3.8
11. Leakage rate through sump bottom (in/hr) = 0
12. Catchbasin Critical Particle Size File Name: Not needed - calculated by program
13. Catchbasin cleaning frequency: Annually

Control Practice 7: Wet Detention Pond CP# 5 (DS) - Dry Pond 70

Particle Size Distribution file name: Not needed - calculated by program

Initial stage elevation (ft): 0  
 Peak to Average Flow Ratio: 3.8  
 Maximum flow allowed into pond (cfs): No maximum value entered  
 Outlet Characteristics:

- Outlet type: Orifice 1
  - 1. Orifice diameter (ft): 0.33
  - 2. Number of orifices: 1
  - 3. Invert elevation above datum (ft): 0
- Outlet type: Broad Crested Weir
  - 1. Weir crest length (ft): 10
  - 2. Weir crest width (ft): 10
  - 3. Height from datum to bottom of weir opening: 2.5
- Outlet type: Vertical Stand Pipe
  - 1. Stand pipe diameter (ft): 1
  - 2. Stand pipe height above datum (ft): 2

Pond stage and surface area

Entry Number	Stage (ft)	Pond Area (acres)	Natural Seepage (in/hr)	Other Outflow (cfs)
0	0.00	0.0000	0.00	0.00
1	0.01	0.0300	0.00	0.00
2	0.50	0.1600	0.00	0.00
3	1.50	0.2000	0.00	0.00
4	2.50	0.2300	0.00	0.00
5	3.50	0.2900	0.00	0.00

Control Practice 8: Wet Detention Pond CP# 6 (DS) - Pond 80

Particle Size Distribution file name: Not needed - calculated by program  
 Initial stage elevation (ft): 5  
 Peak to Average Flow Ratio: 3.8  
 Maximum flow allowed into pond (cfs): No maximum value entered  
 Outlet Characteristics:

- Outlet type: Orifice 1
  - 1. Orifice diameter (ft): 0.33
  - 2. Number of orifices: 1
  - 3. Invert elevation above datum (ft): 5
- Outlet type: Broad Crested Weir
  - 1. Weir crest length (ft): 10
  - 2. Weir crest width (ft): 10

3. Height from datum to bottom of weir opening: 8.25

Outlet type: Vertical Stand Pipe

1. Stand pipe diameter (ft): 2.5

2. Stand pipe height above datum (ft): 6.83

Pond stage and surface area

Entry Number	Stage (ft)	Pond Area (acres)	Natural Seepage (in/hr)	Other Outflow (cfs)
0	0.00	0.0000	0.00	0.00
1	0.01	0.0300	0.00	0.00
2	1.00	0.0400	0.00	0.00
3	2.00	0.0500	0.00	0.00
4	3.00	0.0600	0.00	0.00
5	4.00	0.0700	0.00	0.00
6	5.00	0.1300	0.00	0.00
7	5.50	0.1400	0.00	0.00
8	6.50	0.1700	0.00	0.00
9	7.50	0.2100	0.00	0.00
10	8.50	0.2400	0.00	0.00
11	9.00	0.2800	0.00	0.00

Control Practice 9: Biofilter CP# 2 (DS) - Bio 90

1. Top area (square feet) = 7466

2. Bottom area (square feet) = 2451

3. Depth (ft): 3.4

4. Biofilter width (ft) - for Cost Purposes Only: 10

5. Infiltration rate (in/hr) = 0.13

6. Random infiltration rate generation? No

7. Infiltration rate fraction (side): 1

8. Infiltration rate fraction (bottom): 1

9. Depth of biofilter that is rock filled (ft) 0

10. Porosity of rock filled volume = 0

11. Engineered soil infiltration rate: 3.6

12. Engineered soil depth (ft) = 1.5

13. Engineered soil porosity = 0.26

14. Percent solids reduction due to flow through engineered soil = 80

15. Biofilter peak to average flow ratio = 3.8

16. Number of biofiltration control devices = 1

17. Particle size distribution file: Not needed - calculated by program

18. Initial water surface elevation (ft): 0  
Soil Data Soil Type Fraction in Eng. Soil  
User-Defined Soil Type 1.000  
Biofilter Outlet/Discharge Characteristics:  
Outlet type: Broad Crested Weir  
1. Weir crest length (ft): 10  
2. Weir crest width (ft): 10  
3. Height of datum to bottom of weir opening: 2.4  
Outlet type: Vertical Stand Pipe  
1. Stand pipe diameter (ft): 1  
2. Stand pipe height above datum (ft): 1.75  
Outlet type: Drain Tile/Underdrain  
1. Underdrain outlet diameter (ft): 0.33  
2. Invert elevation above datum (ft): 0.25  
3. Number of underdrain outlets: 1

Control Practice 10: Biofilter CP# 3 (DS) - Bio 100

1. Top area (square feet) = 9713  
2. Bottom area (square feet) = 4069  
3. Depth (ft): 5.5  
4. Biofilter width (ft) - for Cost Purposes Only: 10  
5. Infiltration rate (in/hr) = 0.13  
6. Random infiltration rate generation? No  
7. Infiltration rate fraction (side): 1  
8. Infiltration rate fraction (bottom): 1  
9. Depth of biofilter that is rock filled (ft) 0  
10. Porosity of rock filled volume = 0  
11. Engineered soil infiltration rate: 3.6  
12. Engineered soil depth (ft) = 1.5  
13. Engineered soil porosity = 0.26  
14. Percent solids reduction due to flow through engineered soil = 80  
15. Biofilter peak to average flow ratio = 3.8  
16. Number of biofiltration control devices = 1  
17. Particle size distribution file: Not needed - calculated by program  
18. Initial water surface elevation (ft): 0  
Soil Data Soil Type Fraction in Eng. Soil  
User-Defined Soil Type 1.000  
Biofilter Outlet/Discharge Characteristics:



Outlet type: Broad Crested Weir  
1. Weir crest length (ft): 10  
2. Weir crest width (ft): 10  
3. Height of datum to bottom of weir opening: 3

Outlet type: Vertical Stand Pipe  
1. Stand pipe diameter (ft): 1  
2. Stand pipe height above datum (ft): 1.75

Outlet type: Drain Tile/Underdrain  
1. Underdrain outlet diameter (ft): 0.33  
2. Invert elevation above datum (ft): 0.25  
3. Number of underdrain outlets: 1

# APPENDIX D

WinSLAMM Infiltration Analysis

# INFILTRATION

## INFILTRATION SUMMARY

### PRE-DEVELOPMENT

Area = 57.37 acres (2,499,037 sf)

Average Annual Rainfall (Milwaukee) = 29.02 inches (2.42 ft)

Total Rainfall Volume =  $2,499,037 \times 2.42 = 6,047,669$  cu-ft

Total Runoff = 317,396 cu-ft (from SLAMM Output)

Total Pre-Development Infiltrated Volume =  $6,047,669 - 317,396 = 5,730,273$  cu-ft

### POST-DEVELOPMENT

Total Runoff = 1,594,000 cu-ft (from SLAMM Output)

Total Post-Development Infiltration Volume =  $6,047,669 - 1,594,000 = 4,453,669$  cu-ft

### PERCENT INFILTRATED

Post Infiltration Vol / Pre Infiltration Vol =  $(4,453,669 / 5,730,273) \times 100 = 78\%$

SLAMM for Windows Version 10.4.1

(c) Copyright Robert Pitt and John Voorhees 2019, All Rights Reserved

Data file name: D:\Jobs\2020\2020-012\_Standing Stone - TRIO\Project\_Information\Calcs\SLAMM\Infiltration\Pre-Development\_Infiltration\_2020-012.mdb

Data file description:

Rain file name: C:\WinSLAMM Files\Rain Files\WI Milwaukee 69.RAN

Particulate Solids Concentration file name: C:\WinSLAMM Files\v10.1 WI\_AVG01.pscx

Runoff Coefficient file name: C:\WinSLAMM Files\WI\_SL06 Dec06.rsvx

Pollutant Relative Concentration file name: C:\WinSLAMM Files\WI\_GEO03.ppdx

Residential Street Delivery file name: C:\WinSLAMM Files\WI\_Res and Other Urban Dec06.std

Institutional Street Delivery file name: C:\WinSLAMM Files\WI\_Com Inst Indust Dec06.std

Commercial Street Delivery file name: C:\WinSLAMM Files\WI\_Com Inst Indust Dec06.std

Industrial Street Delivery file name: C:\WinSLAMM Files\WI\_Com Inst Indust Dec06.std

Other Urban Street Delivery file name: C:\WinSLAMM Files\WI\_Res and Other Urban Dec06.std

Freeway Street Delivery file name: C:\WinSLAMM Files\Freeway Dec06.std

Apply Street Delivery Files to Adjust the After Event Load Street Dirt Mass Balance: False

Source Area PSD and Peak to Average Flow Ratio File: C:\WinSLAMM Files\NURP Source Area PSD Files.csv

Cost Data file name:

If Other Device Pollutant Load Reduction Values = 1, Off-site Pollutant Loads are Removed from Pollutant Load % Reduction calculations

Seed for random number generator: -42

Start of Winter Season: 12/06 End of Winter Season: 03/28

Model Run Start Date: 01/05/69 Model Run End Date: 12/31/69

Date of run: 11-11-2020 Time of run: 21:00:41

Total Area Modeled (acres): 57.370

Years in Model Run: 0.99

	Runoff Volume (cu ft)	Percent Runoff Volume Reduction	Particulate Solids Conc. (mg/L)	Particulate Solids Yield (lbs)	Percent Particulate Solids Reduction
Total of all Land Uses without Controls:	317397	-	23.37	463.0	-
Outfall Total with Controls:	317396	0.00%	23.37	463.0	0.00%
Annualized Total After Outfall Controls:	321804			469.4	

Data file name: D:\Jobs\2020\2020-012\_Standing Stone - TRIO\Project\_Information\Calcs\SLAMM\Infiltration\Pre-Development\_Infiltration\_2020-012.mdb

WinSLAMM Version 10.4.1

Rain file name: C:\WinSLAMM Files\Rain Files\WI Milwaukee 69.RAN

Particulate Solids Concentration file name: C:\WinSLAMM Files\v10.1 WI\_AVG01.pscx

Runoff Coefficient file name: C:\WinSLAMM Files\WI\_SL06 Dec06.rsvx

Residential Street Delivery file name: C:\WinSLAMM Files\WI\_Res and Other Urban Dec06.std

Institutional Street Delivery file name: C:\WinSLAMM Files\WI\_Com Inst Indust Dec06.std

Commercial Street Delivery file name: C:\WinSLAMM Files\WI\_Com Inst Indust Dec06.std

Industrial Street Delivery file name: C:\WinSLAMM Files\WI\_Com Inst Indust Dec06.std

Other Urban Street Delivery file name: C:\WinSLAMM Files\WI\_Res and Other Urban Dec06.std

Freeway Street Delivery file name: C:\WinSLAMM Files\Freeway Dec06.std

Apply Street Delivery Files to Adjust the After Event Load Street Dirt Mass Balance: False

Pollutant Relative Concentration file name: C:\WinSLAMM Files\WI\_GEO03.ppdx

Source Area PSD and Peak to Average Flow Ratio File: C:\WinSLAMM Files\NURP Source Area PSD Files.csv

Cost Data file name:

If Other Device Pollutant Load Reduction Values = 1, Off-site Pollutant Loads are Removed from Pollutant Load % Reduction calculations

Seed for random number generator: -42

Study period starting date: 01/05/69

Study period ending date: 12/31/69

Start of Winter Season: 12/06

End of Winter Season: 03/28

Date: 11-11-2020

Time: 21:00:49

Site information:

LU# 1 - Residential: Pre-Development Total area (ac): 57.370

37 - Streets 1: 0.200 ac. Smooth Street Length = 0.085 curb-mi Street Width (assuming two curb-mi per street mile) = 38.82353 ft

Default St. Dirt Accum. Annual Winter Load = 2500 lbs Source Area PSD File: C:\WinSLAMM Files\NURP.cpz

57 - Undeveloped Areas 1: 57.170 ac. Normal Silty Source Area PSD File: C:\WinSLAMM Files\NURP.cpz

SLAMM for Windows Version 10.4.1

(c) Copyright Robert Pitt and John Voorhees 2019, All Rights Reserved

Data file name: D:\Jobs\2020\2020-012\_Standing Stone -  
TRIO\Project\_Information\Calcs\SLAMM\Infiltration\Proposed\_Disconnected\_2020-012.mdb

Data file description:

Rain file name: C:\WinSLAMM Files\Rain Files\WisReg - Milwaukee WI 1969.RAN

Particulate Solids Concentration file name: C:\WinSLAMM Files\v10.1 WI\_AVG01.pscx

Runoff Coefficient file name: C:\WinSLAMM Files\WI\_SL06 Dec06.rsvx

Pollutant Relative Concentration file name: C:\WinSLAMM Files\WI\_GEO03.ppdx

Residential Street Delivery file name: C:\WinSLAMM Files\WI\_Res and Other Urban Dec06.std

Institutional Street Delivery file name: C:\WinSLAMM Files\WI\_Com Inst Indust Dec06.std

Commercial Street Delivery file name: C:\WinSLAMM Files\WI\_Com Inst Indust Dec06.std

Industrial Street Delivery file name: C:\WinSLAMM Files\WI\_Com Inst Indust Dec06.std

Other Urban Street Delivery file name: C:\WinSLAMM Files\WI\_Res and Other Urban Dec06.std

Freeway Street Delivery file name: C:\WinSLAMM Files\Freeway Dec06.std

Apply Street Delivery Files to Adjust the After Event Load Street Dirt Mass Balance: False

Source Area PSD and Peak to Average Flow Ratio File: C:\WinSLAMM Files\NURP Source Area PSD Files.csv

Cost Data file name:

If Other Device Pollutant Load Reduction Values = 1, Off-site Pollutant Loads are Removed from Pollutant Load  
% Reduction calculations

Seed for random number generator: -42

Start of Winter Season: 12/06 End of Winter Season: 03/28

Model Run Start Date: 01/05/69 Model Run End Date: 12/31/69

Date of run: 11-11-2020 Time of run: 21:09:27

Total Area Modeled (acres): 57.370

Years in Model Run: 0.99

	Runoff Volume (cu ft)	Percent Runoff Volume Reduction	Particulate Solids Conc. (mg/L)	Particulate Solids Yield (lbs)	Percent Particulate Solids Reduction
Total of all Land Uses without Controls:	2.112E+06	-	101.1	13332	-
Outfall Total with Controls:	1.594E+06	24.53%	29.58	2944	77.92%
Annualized Total After Outfall Controls:	1.616E+06			2985	

Data file name: D:\Jobs\2020\2020-012\_Standing Stone -  
TRIO\Project\_Information\Calcs\SLAMM\Infiltration\Proposed\_Disconnected\_2020-012.mdb  
WinSLAMM Version 10.4.1  
Rain file name: C:\WinSLAMM Files\Rain Files\WisReg - Milwaukee WI 1969.RAN  
Particulate Solids Concentration file name: C:\WinSLAMM Files\v10.1 WI\_AVG01.pscx  
Runoff Coefficient file name: C:\WinSLAMM Files\WI\_SL06 Dec06.rsvx  
Residential Street Delivery file name: C:\WinSLAMM Files\WI\_Res and Other Urban Dec06.std  
Institutional Street Delivery file name: C:\WinSLAMM Files\WI\_Com Inst Indust Dec06.std  
Commercial Street Delivery file name: C:\WinSLAMM Files\WI\_Com Inst Indust Dec06.std  
Industrial Street Delivery file name: C:\WinSLAMM Files\WI\_Com Inst Indust Dec06.std  
Other Urban Street Delivery file name: C:\WinSLAMM Files\WI\_Res and Other Urban Dec06.std  
Freeway Street Delivery file name: C:\WinSLAMM Files\Freeway Dec06.std  
Apply Street Delivery Files to Adjust the After Event Load Street Dirt Mass Balance: False  
Pollutant Relative Concentration file name: C:\WinSLAMM Files\WI\_GEO03.ppdx  
Source Area PSD and Peak to Average Flow Ratio File: C:\WinSLAMM Files\NURP Source Area PSD Files.csv  
Cost Data file name:  
If Other Device Pollutant Load Reduction Values = 1, Off-site Pollutant Loads are Removed from Pollutant Load  
% Reduction calculations  
Seed for random number generator: -42  
Study period starting date: 01/05/69 Study period ending date: 12/31/69  
Start of Winter Season: 12/06 End of Winter Season: 03/28  
Date: 11-11-2020 Time: 21:09:35  
Site information:

LU# 1 - Residential: Subarea 10 Total area (ac): 5.430  
1 - Roofs 1: 1.160 ac. Pitched Connected Source Area PSD File: C:\WinSLAMM Files\NURP.cpz  
13 - Paved Parking 1: 0.970 ac. Connected Source Area PSD File: C:\WinSLAMM Files\NURP.cpz  
45 - Large Landscaped Areas 1: 3.170 ac. Normal Silty Source Area PSD File: C:\WinSLAMM  
Files\NURP.cpz  
70 - Water Body Areas: 0.130 ac. Source Area PSD File:

LU# 2 - Residential: Subarea 20 Total area (ac): 6.860  
1 - Roofs 1: 0.650 ac. Pitched Connected Source Area PSD File: C:\WinSLAMM Files\NURP.cpz  
25 - Driveways 1: 0.270 ac. Connected Source Area PSD File: C:\WinSLAMM Files\NURP.cpz  
31 - Sidewalks 1: 0.740 ac. Connected Source Area PSD File: C:\WinSLAMM Files\NURP.cpz  
37 - Streets 1: 1.010 ac. Smooth Street Length = 0.427 curb-mi Street Width (assuming two curb-  
mi per street mile) = 39.0281 ft  
Default St. Dirt Accum. Annual Winter Load = 2500 lbs Source Area PSD File: C:\WinSLAMM  
Files\NURP.cpz

45 - Large Landscaped Areas 1: 3.850 ac. Normal Silty Source Area PSD File: C:\WinSLAMM  
 Files\NURP.cpz  
 69 - Isolated Areas: 0.020 ac. Source Area PSD File:  
 70 - Water Body Areas: 0.320 ac. Source Area PSD File:  
 LU# 3 - Residential: Subarea 30 Total area (ac): 17.030  
 1 - Roofs 1: 2.250 ac. Pitched Connected Source Area PSD File: C:\WinSLAMM Files\NURP.cpz  
 2 - Roofs 2: 0.880 ac. Pitched Connected Source Area PSD File: C:\WinSLAMM Files\NURP.cpz  
 25 - Driveways 1: 1.610 ac. Connected Source Area PSD File: C:\WinSLAMM Files\NURP.cpz  
 26 - Driveways 2: 0.240 ac. Connected Source Area PSD File: C:\WinSLAMM Files\NURP.cpz  
 31 - Sidewalks 1: 0.430 ac. Connected Source Area PSD File: C:\WinSLAMM Files\NURP.cpz  
 32 - Sidewalks 2: 0.330 ac. Connected Source Area PSD File: C:\WinSLAMM Files\NURP.cpz  
 37 - Streets 1: 1.310 ac. Smooth Street Length = 0.554 curb-mi Street Width (assuming two curb-  
 mi per street mile) = 39.01624 ft  
 Default St. Dirt Accum. Annual Winter Load = 2500 lbs Source Area PSD File: C:\WinSLAMM  
 Files\NURP.cpz  
 38 - Streets 2: 0.730 ac. Smooth Street Length = 0.309 curb-mi Street Width (assuming two curb-  
 mi per street mile) = 38.98059 ft  
 Default St. Dirt Accum. Annual Winter Load = 2500 lbs Source Area PSD File: C:\WinSLAMM  
 Files\NURP.cpz  
 45 - Large Landscaped Areas 1: 8.850 ac. Normal Silty Source Area PSD File: C:\WinSLAMM  
 Files\NURP.cpz  
 70 - Water Body Areas: 0.400 ac. Source Area PSD File:  
 LU# 4 - Residential: Subarea 40 Total area (ac): 3.950  
 1 - Roofs 1: 0.470 ac. Pitched Connected Source Area PSD File: C:\WinSLAMM Files\NURP.cpz  
 25 - Driveways 1: 0.310 ac. Connected Source Area PSD File: C:\WinSLAMM Files\NURP.cpz  
 31 - Sidewalks 1: 0.300 ac. Connected Source Area PSD File: C:\WinSLAMM Files\NURP.cpz  
 37 - Streets 1: 0.930 ac. Smooth Street Length = 0.393 curb-mi Street Width (assuming two curb-  
 mi per street mile) = 39.0458 ft  
 Default St. Dirt Accum. Annual Winter Load = 2500 lbs Source Area PSD File: C:\WinSLAMM  
 Files\NURP.cpz  
 45 - Large Landscaped Areas 1: 1.800 ac. Normal Silty Source Area PSD File: C:\WinSLAMM  
 Files\NURP.cpz  
 70 - Water Body Areas: 0.140 ac. Source Area PSD File:  
 LU# 5 - Residential: Subarea 45 Total area (ac): 2.400  
 1 - Roofs 1: 0.310 ac. Pitched Connected Source Area PSD File: C:\WinSLAMM Files\NURP.cpz  
 31 - Sidewalks 1: 0.110 ac. Connected Source Area PSD File: C:\WinSLAMM Files\NURP.cpz  
 45 - Large Landscaped Areas 1: 1.980 ac. Normal Silty Source Area PSD File: C:\WinSLAMM  
 Files\NURP.cpz



LU# 6 - Residential: Subarea 50 Total area (ac): 3.630  
 1 - Roofs 1: 0.060 ac. Pitched Disconnected Normal Silty Source Area PSD File: C:\WinSLAMM  
 Files\NURP.cpz  
 25 - Driveways 1: 0.020 ac. Disconnected Normal Silty Source Area PSD File: C:\WinSLAMM  
 Files\NURP.cpz  
 31 - Sidewalks 1: 0.040 ac. Disconnected Normal Silty Source Area PSD File: C:\WinSLAMM  
 Files\NURP.cpz  
 32 - Sidewalks 2: 0.130 ac. Connected Source Area PSD File: C:\WinSLAMM Files\NURP.cpz  
 37 - Streets 1: 0.530 ac. Smooth Street Length = 0.224 curb-mi Street Width (assuming two curb-  
 mi per street mile) = 39.04018 ft  
 Default St. Dirt Accum. Annual Winter Load = 2500 lbs Source Area PSD File: C:\WinSLAMM  
 Files\NURP.cpz CB-CP#6  
 45 - Large Landscaped Areas 1: 2.850 ac. Normal Silty Source Area PSD File: C:\WinSLAMM  
 Files\NURP.cpz  
 LU# 7 - Residential: Subarea 60 Total area (ac): 2.330  
 1 - Roofs 1: 0.200 ac. Pitched Disconnected Normal Silty Source Area PSD File: C:\WinSLAMM  
 Files\NURP.cpz  
 31 - Sidewalks 1: 0.190 ac. Disconnected Normal Silty Source Area PSD File: C:\WinSLAMM  
 Files\NURP.cpz  
 45 - Large Landscaped Areas 1: 1.940 ac. Normal Silty Source Area PSD File: C:\WinSLAMM  
 Files\NURP.cpz  
 LU# 8 - Residential: Subarea 70 Total area (ac): 2.690  
 1 - Roofs 1: 0.480 ac. Pitched Disconnected Normal Silty Source Area PSD File: C:\WinSLAMM  
 Files\NURP.cpz  
 31 - Sidewalks 1: 0.010 ac. Disconnected Normal Silty Source Area PSD File: C:\WinSLAMM  
 Files\NURP.cpz  
 45 - Large Landscaped Areas 1: 2.200 ac. Normal Silty Source Area PSD File: C:\WinSLAMM  
 Files\NURP.cpz  
 LU# 9 - Residential: Subarea 80 Total area (ac): 9.660  
 1 - Roofs 1: 0.720 ac. Pitched Connected Source Area PSD File: C:\WinSLAMM Files\NURP.cpz  
 2 - Roofs 2: 0.310 ac. Pitched Connected Source Area PSD File: C:\WinSLAMM Files\NURP.cpz  
 25 - Driveways 1: 1.430 ac. Connected Source Area PSD File: C:\WinSLAMM Files\NURP.cpz  
 31 - Sidewalks 1: 0.370 ac. Connected Source Area PSD File: C:\WinSLAMM Files\NURP.cpz  
 37 - Streets 1: 1.280 ac. Smooth Street Length = 0.542 curb-mi Street Width (assuming two curb-  
 mi per street mile) = 38.96679 ft  
 Default St. Dirt Accum. Annual Winter Load = 2500 lbs Source Area PSD File: C:\WinSLAMM  
 Files\NURP.cpz

45 - Large Landscaped Areas 1: 5.420 ac. Normal Silty Source Area PSD File: C:\WinSLAMM Files\NURP.cpz  
 70 - Water Body Areas: 0.130 ac. Source Area PSD File:  
 LU# 10 - Residential: Subarea 90 Total area (ac): 1.270  
 1 - Roofs 1: 0.360 ac. Pitched Connected Source Area PSD File: C:\WinSLAMM Files\NURP.cpz  
 45 - Large Landscaped Areas 1: 0.910 ac. Normal Silty Source Area PSD File: C:\WinSLAMM Files\NURP.cpz  
 LU# 11 - Residential: Subarea 100 Total area (ac): 2.120  
 1 - Roofs 1: 0.560 ac. Pitched Connected Source Area PSD File: C:\WinSLAMM Files\NURP.cpz  
 45 - Large Landscaped Areas 1: 1.560 ac. Normal Silty Source Area PSD File: C:\WinSLAMM Files\NURP.cpz

Control Practice 1: Wet Detention Pond CP# 1 (DS) - Future Pond 10

Particle Size Distribution file name: Not needed - calculated by program

Initial stage elevation (ft): 5

Peak to Average Flow Ratio: 3.8

Maximum flow allowed into pond (cfs): No maximum value entered

Outlet Characteristics:

Outlet type: Orifice 1

1. Orifice diameter (ft): 0.25
2. Number of orifices: 1
3. Invert elevation above datum (ft): 5

Outlet type: Orifice 2

1. Orifice diameter (ft): 0.92
2. Number of orifices: 1
3. Invert elevation above datum (ft): 6.25

Outlet type: Broad Crested Weir

1. Weir crest length (ft): 10
2. Weir crest width (ft): 10
3. Height from datum to bottom of weir opening: 9

Pond stage and surface area

Entry Number	Stage (ft)	Pond Area (acres)	Natural Seepage (in/hr)	Other Outflow (cfs)
0	0.00	0.0000	0.00	0.00
1	0.01	0.0200	0.00	0.00
2	1.00	0.0300	0.00	0.00
3	3.00	0.0500	0.00	0.00
4	4.00	0.0700	0.00	0.00

5	5.00	0.1300	0.00	0.00
6	7.00	0.1800	0.00	0.00
7	9.00	0.2400	0.00	0.00
8	10.00	0.2800	0.00	0.00

Control Practice 2: Wet Detention Pond CP# 2 (DS) - Pond 20

Particle Size Distribution file name: Not needed - calculated by program

Initial stage elevation (ft): 8

Peak to Average Flow Ratio: 3.8

Maximum flow allowed into pond (cfs): No maximum value entered

Outlet Characteristics:

Outlet type: Orifice 1

1. Orifice diameter (ft): 0.25
2. Number of orifices: 1
3. Invert elevation above datum (ft): 8

Outlet type: Broad Crested Weir

1. Weir crest length (ft): 10
2. Weir crest width (ft): 10
3. Height from datum to bottom of weir opening: 10

Outlet type: Vertical Stand Pipe

1. Stand pipe diameter (ft): 1.5
2. Stand pipe height above datum (ft): 8.75

Pond stage and surface area

Entry Number	Stage (ft)	Pond Area (acres)	Natural Seepage (in/hr)	Other Outflow (cfs)
0	0.00	0.0000	0.00	0.00
1	0.01	0.0800	0.00	0.00
2	1.00	0.1000	0.00	0.00
3	2.00	0.1200	0.00	0.00
4	3.00	0.1400	0.00	0.00
5	4.00	0.1500	0.00	0.00
6	5.00	0.1700	0.00	0.00
7	6.00	0.1900	0.00	0.00
8	7.00	0.2100	0.00	0.00
9	8.00	0.3200	0.00	0.00
10	9.00	0.4900	0.00	0.00
11	10.00	0.6100	0.00	0.00
12	11.00	0.7300	0.00	0.00

13                    12.00                    0.8700                    0.00                    0.00

Control Practice 3: Wet Detention Pond CP# 3 (DS) - Pond 30

Particle Size Distribution file name: Not needed - calculated by program

Initial stage elevation (ft): 6

Peak to Average Flow Ratio: 3.8

Maximum flow allowed into pond (cfs): No maximum value entered

Outlet Characteristics:

Outlet type: Orifice 1

1. Orifice diameter (ft): 0.25
2. Number of orifices: 1
3. Invert elevation above datum (ft): 6

Outlet type: Broad Crested Weir

1. Weir crest length (ft): 10
2. Weir crest width (ft): 10
3. Height from datum to bottom of weir opening: 8

Pond stage and surface area

Entry Number	Stage (ft)	Pond Area (acres)	Natural Seepage (in/hr)	Other Outflow (cfs)
0	0.00	0.0000	0.00	0.00
1	0.01	0.1100	0.00	0.00
2	1.00	0.1300	0.00	0.00
3	2.00	0.1600	0.00	0.00
4	3.00	0.1800	0.00	0.00
5	4.00	0.2100	0.00	0.00
6	5.00	0.2500	0.00	0.00
7	6.00	0.4000	0.00	0.00
8	7.00	0.4700	0.00	0.00
9	8.00	0.5300	0.00	0.00
10	9.00	0.6200	0.00	0.00
11	10.00	0.7100	0.00	0.00
12	11.00	0.8300	0.00	0.00

Control Practice 4: Wet Detention Pond CP# 4 (DS) - Pond 40

Particle Size Distribution file name: Not needed - calculated by program

Initial stage elevation (ft): 5

Peak to Average Flow Ratio: 3.8

Maximum flow allowed into pond (cfs): No maximum value entered

Outlet Characteristics:

Outlet type: Orifice 1

1. Orifice diameter (ft): 0.25
2. Number of orifices: 1
3. Invert elevation above datum (ft): 5

Outlet type: Broad Crested Weir

1. Weir crest length (ft): 10
2. Weir crest width (ft): 10
3. Height from datum to bottom of weir opening: 8.6

Pond stage and surface area

Entry Number	Stage (ft)	Pond Area (acres)	Natural Seepage (in/hr)	Other Outflow	(cfs)
0	0.00	0.0000	0.00		0.00
1	0.01	0.0100	0.00		0.00
2	1.00	0.0200	0.00		0.00
3	2.00	0.0250	0.00		0.00
4	3.00	0.0300	0.00		0.00
5	4.00	0.0500	0.00		0.00
6	5.00	0.1300	0.00		0.00
7	6.00	0.1800	0.00		0.00
8	7.00	0.2500	0.00		0.00
9	8.00	0.3300	0.00		0.00
10	9.00	0.4000	0.00		0.00
11	10.00	0.4900	0.00		0.00

Control Practice 5: Biofilter CP# 1 (DS) - Infiltration Basin 45

1. Top area (square feet) = 30500
2. Bottom area (square feet) = 13453
3. Depth (ft): 6
4. Biofilter width (ft) - for Cost Purposes Only: 10
5. Infiltration rate (in/hr) = 0.13
6. Random infiltration rate generation? No
7. Infiltration rate fraction (side): 1
8. Infiltration rate fraction (bottom): 1
9. Depth of biofilter that is rock filled (ft) 0
10. Porosity of rock filled volume = 0
11. Engineered soil infiltration rate: 0
12. Engineered soil depth (ft) = 0

- 13. Engineered soil porosity = 0
- 14. Percent solids reduction due to flow through engineered soil = 0
- 15. Biofilter peak to average flow ratio = 3.8
- 16. Number of biofiltration control devices = 1
- 17. Particle size distribution file: Not needed - calculated by program
- 18. Initial water surface elevation (ft): 0

Soil Data    Soil Type Fraction in Eng. Soil

Biofilter Outlet/Discharge Characteristics:

- Outlet type: Broad Crested Weir
  - 1. Weir crest length (ft): 10
  - 2. Weir crest width (ft): 10
  - 3. Height of datum to bottom of weir opening: 5
- Outlet type: Surface Discharge Pipe
  - 1. Surface discharge pipe outlet diameter (ft): 0.25
  - 2. Pipe invert elevation above datum (ft): 0.25
  - 3. Number of surface pipe outlets: 1

Outlet type: Other Outlet

Stage Number	Stage (ft)	Discharge Rate (cfs)
2	1.00	0.000
3	2.00	0.390
4	3.00	7.860
5	4.00	16.910
6	5.00	22.690
7	6.00	27.270

Control Practice 6: Catchbasin Cleaning CP# 1 (SA) - SA Device, LU# 6 ,SA# 37

- 1. Fraction of area served by catchbasins = 1.00
- 2. Number of catchbasins = 2
- 3. Average sump depth below catchbasin outlet invert (feet) = 3
- 4. Depth of sediment in catchbasin sump at beginning of study period (ft) = 0
- 5. Typical outlet pipe diameter (ft) = 1
- 6. Typical outlet pipe Mannings n = 0.013
- 7. Typical outlet pipe slope (ft/ft) = 0.02
- 8. Typical catchbasin sump surface area (square feet) = 16
- 9. Total catchbasin depth (feet) = 8
- 10. Inflow hydrograph peak to average flow ratio = 3.8
- 11. Leakage rate through sump bottom (in/hr) = 0

- 12. Catchbasin Critical Particle Size File Name: Not needed - calculated by program
- 13. Catchbasin cleaning frequency: Annually

Control Practice 7: Wet Detention Pond CP# 5 (DS) - Dry Pond 70

Particle Size Distribution file name: Not needed - calculated by program

Initial stage elevation (ft): 0

Peak to Average Flow Ratio: 3.8

Maximum flow allowed into pond (cfs): No maximum value entered

Outlet Characteristics:

Outlet type: Orifice 1

- 1. Orifice diameter (ft): 0.33
- 2. Number of orifices: 1
- 3. Invert elevation above datum (ft): 0

Outlet type: Broad Crested Weir

- 1. Weir crest length (ft): 10
- 2. Weir crest width (ft): 10
- 3. Height from datum to bottom of weir opening: 2.5

Outlet type: Vertical Stand Pipe

- 1. Stand pipe diameter (ft): 1
- 2. Stand pipe height above datum (ft): 2

Pond stage and surface area

Entry Number	Stage (ft)	Pond Area (acres)	Natural Seepage (in/hr)	Other Outflow (cfs)
0	0.00	0.0000	0.00	0.00
1	0.01	0.0300	0.00	0.00
2	0.50	0.1600	0.00	0.00
3	1.50	0.2000	0.00	0.00
4	2.50	0.2300	0.00	0.00
5	3.50	0.2900	0.00	0.00

Control Practice 8: Wet Detention Pond CP# 6 (DS) - Pond 80

Particle Size Distribution file name: Not needed - calculated by program

Initial stage elevation (ft): 5

Peak to Average Flow Ratio: 3.8

Maximum flow allowed into pond (cfs): No maximum value entered

Outlet Characteristics:

Outlet type: Orifice 1

- 1. Orifice diameter (ft): 0.33

- 2. Number of orifices: 1
- 3. Invert elevation above datum (ft): 5
- Outlet type: Broad Crested Weir
  - 1. Weir crest length (ft): 10
  - 2. Weir crest width (ft): 10
  - 3. Height from datum to bottom of weir opening: 8.25
- Outlet type: Vertical Stand Pipe
  - 1. Stand pipe diameter (ft): 2.5
  - 2. Stand pipe height above datum (ft): 6.83

Pond stage and surface area

Entry Number	Stage (ft)	Pond Area (acres)	Natural Seepage (in/hr)	Other Outflow (cfs)
0	0.00	0.0000	0.00	0.00
1	0.01	0.0300	0.00	0.00
2	1.00	0.0400	0.00	0.00
3	2.00	0.0500	0.00	0.00
4	3.00	0.0600	0.00	0.00
5	4.00	0.0700	0.00	0.00
6	5.00	0.1300	0.00	0.00
7	5.50	0.1400	0.00	0.00
8	6.50	0.1700	0.00	0.00
9	7.50	0.2100	0.00	0.00
10	8.50	0.2400	0.00	0.00
11	9.00	0.2800	0.00	0.00

Control Practice 9: Biofilter CP# 2 (DS) - Bio 90

- 1. Top area (square feet) = 7466
- 2. Bottom area (square feet) = 2451
- 3. Depth (ft): 3.4
- 4. Biofilter width (ft) - for Cost Purposes Only: 10
- 5. Infiltration rate (in/hr) = 0.13
- 6. Random infiltration rate generation? No
- 7. Infiltration rate fraction (side): 1
- 8. Infiltration rate fraction (bottom): 1
- 9. Depth of biofilter that is rock filled (ft) 0
- 10. Porosity of rock filled volume = 0
- 11. Engineered soil infiltration rate: 3.6
- 12. Engineered soil depth (ft) = 1.5



13. Engineered soil porosity = 0.26
14. Percent solids reduction due to flow through engineered soil = 80
15. Biofilter peak to average flow ratio = 3.8
16. Number of biofiltration control devices = 1
17. Particle size distribution file: Not needed - calculated by program
18. Initial water surface elevation (ft): 0

Soil Data    Soil Type Fraction in Eng. Soil

User-Defined Soil Type                          1.000

Biofilter Outlet/Discharge Characteristics:

Outlet type: Broad Crested Weir

1. Weir crest length (ft): 10
2. Weir crest width (ft): 10
3. Height of datum to bottom of weir opening: 2.4

Outlet type: Vertical Stand Pipe

1. Stand pipe diameter (ft): 1
2. Stand pipe height above datum (ft): 1.75

Outlet type: Drain Tile/Underdrain

1. Underdrain outlet diameter (ft): 0.33
2. Invert elevation above datum (ft): 0.25
3. Number of underdrain outlets: 1

Control Practice 10: Biofilter CP# 3 (DS) - Bio 100

1. Top area (square feet) = 9713
2. Bottom area (square feet) = 4069
3. Depth (ft): 5.5
4. Biofilter width (ft) - for Cost Purposes Only: 10
5. Infiltration rate (in/hr) = 0.13
6. Random infiltration rate generation? No
7. Infiltration rate fraction (side): 1
8. Infiltration rate fraction (bottom): 1
9. Depth of biofilter that is rock filled (ft) 0
10. Porosity of rock filled volume = 0
11. Engineered soil infiltration rate: 3.6
12. Engineered soil depth (ft) = 1.5
13. Engineered soil porosity = 0.26
14. Percent solids reduction due to flow through engineered soil = 80
15. Biofilter peak to average flow ratio = 3.8
16. Number of biofiltration control devices = 1

17. Particle size distribution file: Not needed - calculated by program

18. Initial water surface elevation (ft): 0

Soil Data    Soil Type Fraction in Eng. Soil

    User-Defined Soil Type                          1.000

Biofilter Outlet/Discharge Characteristics:

    Outlet type: Broad Crested Weir

        1. Weir crest length (ft): 10

        2. Weir crest width (ft): 10

        3. Height of datum to bottom of weir opening: 3

    Outlet type: Vertical Stand Pipe

        1. Stand pipe diameter (ft): 1

        2. Stand pipe height above datum (ft): 1.75

    Outlet type: Drain Tile/Underdrain

        1. Underdrain outlet diameter (ft): 0.33

        2. Invert elevation above datum (ft): 0.25

        3. Number of underdrain outlets: 1

# APPENDIX E

NRCS Soil Survey

Hydrologic Soil Group—Milwaukee and Waukesha Counties, Wisconsin

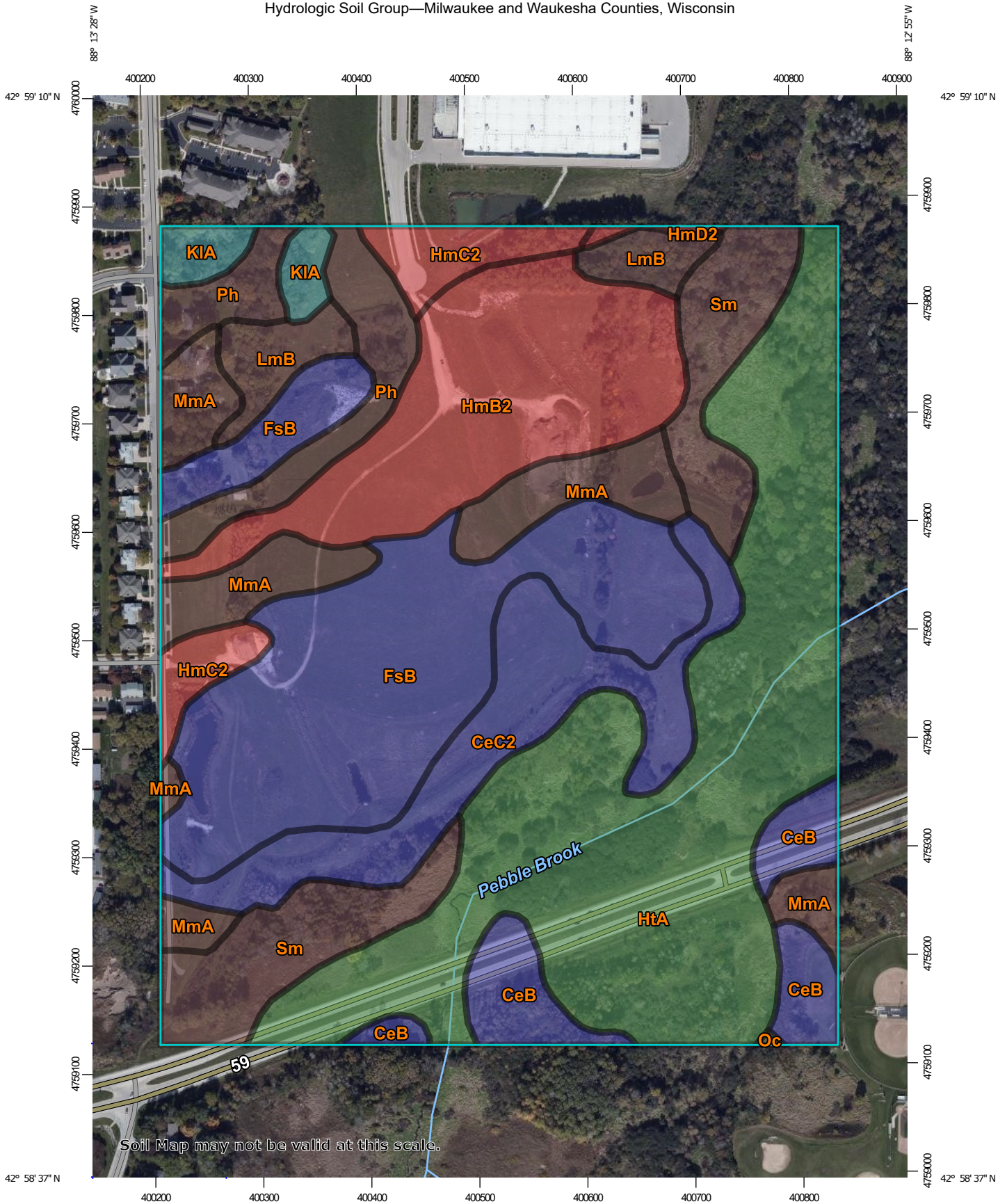

## MAP LEGEND

### Area of Interest (AOI)









 Area of Interest (AOI)

### Soils

#### Soil Rating Polygons





 A  
 A/D  
 B  
 B/D  
 C  
 C/D  
 D  
 Not rated or not available

#### Soil Rating Lines

 A  
 A/D  
 B  
 B/D  
 C  
 C/D  
 D  
 Not rated or not available

#### Soil Rating Points





 A  
 A/D  
 B  
 B/D

 C  
 C/D  
 D  
 Not rated or not available

### Water Features

 Streams and Canals

### Transportation

 Rails  
 Interstate Highways  
 US Routes  
 Major Roads  
 Local Roads

### Background

 Aerial Photography

## MAP INFORMATION

The soil surveys that comprise your AOI were mapped at 1:15,800.

**Warning:** Soil Map may not be valid at this scale.

Enlargement of maps beyond the scale of mapping can cause misunderstanding of the detail of mapping and accuracy of soil line placement. The maps do not show the small areas of contrasting soils that could have been shown at a more detailed scale.

Please rely on the bar scale on each map sheet for map measurements.

Source of Map: Natural Resources Conservation Service  
 Web Soil Survey URL:  
 Coordinate System: Web Mercator (EPSG:3857)

Maps from the Web Soil Survey are based on the Web Mercator projection, which preserves direction and shape but distorts distance and area. A projection that preserves area, such as the Albers equal-area conic projection, should be used if more accurate calculations of distance or area are required.

This product is generated from the USDA-NRCS certified data as of the version date(s) listed below.

Soil Survey Area: Milwaukee and Waukesha Counties, Wisconsin  
 Survey Area Data: Version 16, Jun 8, 2020

Soil map units are labeled (as space allows) for map scales 1:50,000 or larger.

Date(s) aerial images were photographed: Aug 1, 2019—Oct 20, 2019

The orthophoto or other base map on which the soil lines were compiled and digitized probably differs from the background imagery displayed on these maps. As a result, some minor shifting of map unit boundaries may be evident.

## Hydrologic Soil Group

Map unit symbol	Map unit name	Rating	Acres in AOI	Percent of AOI
CeB	Casco loam, 2 to 6 percent slopes	B	5.4	4.6%
CeC2	Casco loam, 6 to 12 percent slopes, eroded	B	9.7	8.3%
FsB	Fox silt loam, 2 to 6 percent slopes	B	22.1	18.8%
HmB2	Hochheim loam, 2 to 6 percent slopes, eroded	D	14.3	12.2%
HmC2	Hochheim loam, 6 to 12 percent slopes, eroded	D	3.5	3.0%
HmD2	Hochheim loam, 12 to 20 percent slopes, eroded	D	0.2	0.2%
HtA	Houghton muck, 0 to 2 percent slopes	A/D	33.0	28.0%
KIA	Kendall silt loam, 1 to 3 percent slopes	C	1.8	1.5%
LmB	Lamartine silt loam, 0 to 3 percent slopes	B/D	3.3	2.8%
MmA	Matherton silt loam, 1 to 3 percent slopes	B/D	8.8	7.5%
Oc	Ogden muck	C/D	0.0	0.0%
Ph	Pella silt loam, 0 to 2 percent slopes	B/D	5.6	4.8%
Sm	Sebewa silt loam, 0 to 2 percent slopes	B/D	9.7	8.3%
<b>Totals for Area of Interest</b>			<b>117.5</b>	<b>100.0%</b>

## Description

Hydrologic soil groups are based on estimates of runoff potential. Soils are assigned to one of four groups according to the rate of water infiltration when the soils are not protected by vegetation, are thoroughly wet, and receive precipitation from long-duration storms.

The soils in the United States are assigned to four groups (A, B, C, and D) and three dual classes (A/D, B/D, and C/D). The groups are defined as follows:

Group A. Soils having a high infiltration rate (low runoff potential) when thoroughly wet. These consist mainly of deep, well drained to excessively drained sands or gravelly sands. These soils have a high rate of water transmission.

Group B. Soils having a moderate infiltration rate when thoroughly wet. These consist chiefly of moderately deep or deep, moderately well drained or well drained soils that have moderately fine texture to moderately coarse texture. These soils have a moderate rate of water transmission.

Group C. Soils having a slow infiltration rate when thoroughly wet. These consist chiefly of soils having a layer that impedes the downward movement of water or soils of moderately fine texture or fine texture. These soils have a slow rate of water transmission.

Group D. Soils having a very slow infiltration rate (high runoff potential) when thoroughly wet. These consist chiefly of clays that have a high shrink-swell potential, soils that have a high water table, soils that have a claypan or clay layer at or near the surface, and soils that are shallow over nearly impervious material. These soils have a very slow rate of water transmission.

If a soil is assigned to a dual hydrologic group (A/D, B/D, or C/D), the first letter is for drained areas and the second is for undrained areas. Only the soils that in their natural condition are in group D are assigned to dual classes.

## Rating Options

*Aggregation Method:* Dominant Condition

*Component Percent Cutoff:* None Specified

*Tie-break Rule:* Higher