

E-WFG Series

LED Full Cutoff Architectural Wall Pack
Replaces up to 250W MH



If Indiana Jones was a wall pack.

Okay, not exactly. But these LED Architectural Wall Packs sure are tall, dark, and affordable.

Recommended Use

- Security
- Pathways
- Perimeter Lighting

Input Voltage

- Universal (120V through 277V Operation)

Benefits

- Multiple output options in the same form factor and family style allow for a similar look that meets the needs of your whole facility
- Complete offering in 3000K, 4000K, and 5000K

Certifications



*See output specifications



WARNING: Cancer and Reproductive Harm - www.p65warnings.ca.gov



E-WFG Series

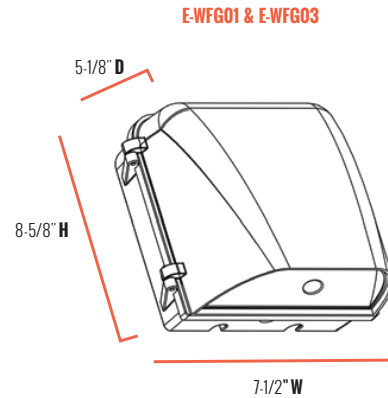
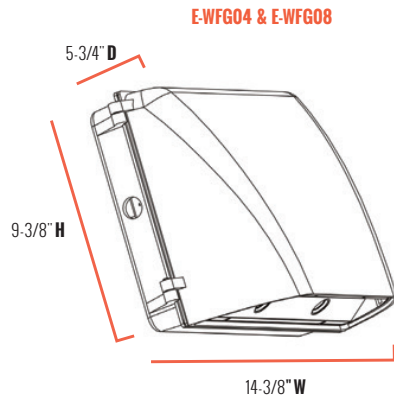

Series Overview

DIMENSIONS	PRODUCT WEIGHT	MOUNTING HEIGHT	SPACING
E-WFG04 & E-WFG08 14-3/8" W X 9-3/8" H X 5-3/4" D	8.6 lbs.	10 to 20 feet	2 to 3 times the mounting height
E-WFG01 & E-WFG03 7-1/2" W X 8-5/8" H X 5-1/8" D	4.8 lbs.	8 to 15 feet	

Fixture Specifications

HOUSING	Durable, die cast aluminum heat sink & housing UV stabilized dark bronze polyester powder-coat finish
LENS ASSEMBLY	Impact resistant tempered glass, metal reflector
MOUNTING	Included mounting plate allows for simple installation on j-box or surface. Threaded conduit plugs for surface conduit entry on both sides and top.

Electrical Performance

OPERATING RANGE	LIFESPAN <small>L70 AT 25°C (77°F)</small>	POWER FACTOR	TOTAL HARMONIC DISTORTION	DIMMABLE
-40°C (-40°F)	Estimated >100,000 Hours	> 0.9	< 20%	No
INPUT VOLTAGE <small>Current Draw (Amps)</small>	120V	208V	240V	277V
E-WFG08A	0.61A	0.35A	0.30A	0.26A
E-WFG04A	0.29A	0.17A	0.15A	0.13A
E-WFG03A	0.23A	0.13A	0.12A	0.10A
E-WFG01A	0.09A	0.05A	0.05A	0.04A

CORRELATED COLOR TEMPERATURE (CCT)

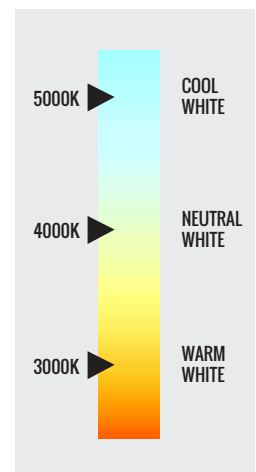













E-WFG Series

Warranty & Certifications

WARRANTY	cULus LISTED	DLC
5-Year Limited	Wet Locations	Yes, See output specifications

Output Specifications

SKU	REPLACES	LIGHT OUTPUT	COLOR TEMP	POWER CONSUMPTION	COLOR ACCURACY	DLC
E-WFG08A-F50UZ	250W MH	8900 Lumens	Cool White (5000K)	73W	≥ 70 CRII	
E-WFG08A-F40UZ			Neutral White (4000K)			
E-WFG08A-F30UZ			Warm White (3000K)			
E-WFG04A-F50UZ	150W PSMH	4900 Lumens	Cool White (5000K)			
E-WFG04A-F40UZ			Neutral White (4000K)			
E-WFG04A-F30UZ			Warm White (3000K)			
E-WFG03A-F50UZ	100W PSMH	3100 Lumens	Cool White (5000K)	28W		
E-WFG03A-F40UZ			Neutral White (4000K)			
E-WFG03A-F30UZ			Warm White (3000K)			
E-WFG01A-F50UZ	50W MH	1500 Lumens	Cool White (5000K)	11W		
E-WFG01A-F40UZ			Neutral White (4000K)			
E-WFG01A-F30UZ			Warm White (3000K)			

Accessories



Photocell - Button, 120V/208V/240V/277V

SKU: E-ACP1 (120V)

E-ACP2 (208/240/277V)

Use: Photocell is field installed. For use with 2" adjustable fitter mount.

Due to continuous product improvement, information in this document is subject to change. The cULus logo is a registered trademark of UL LLC. The DLC QPL logo and the DLC QPL Premium logo are registered trademarks of Northeast Efficiency Partnerships, Inc.

Revision Date: 02/18/20

1501 96th Street, Sturtevant, WI 53177 | Phone (888) 243-9445 | Fax (262) 504-5409 | www.e-conolight.com

