

# TIMBER VIEW ESTATES

BEING A REDIVISION OF PART OF LOT 1 AND PART OF LOT 2, CERTIFIED SURVEY MAP NO. 9681,  
 LOCATED IN THE SW 1/4 OF THE NW 1/4 AND THE NW 1/4 AND NE 1/4 OF THE SW 1/4  
 OF SECTION 22, TOWN 6 NORTH, RANGE 19 EAST, IN THE CITY OF WAUKESHA,  
 WAUKESHA COUNTY, WISCONSIN

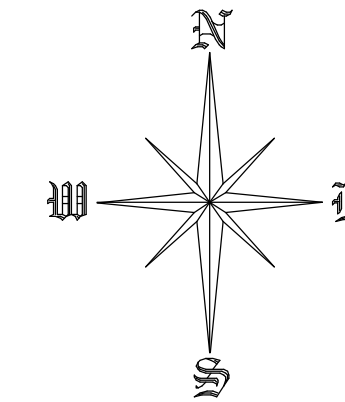

BEARINGS ARE REFERENCED TO THE WISCONSIN STATE  
 PLANE COORDINATE SYSTEM SOUTH ZONE (NAD 1927)  
 THE WEST LINE OF THE SW 1/4 OF SEC. 22 T6N. R19E.  
 AS S 00°09'06" E

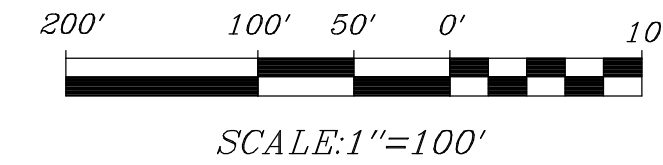

## LOCALITY MAP

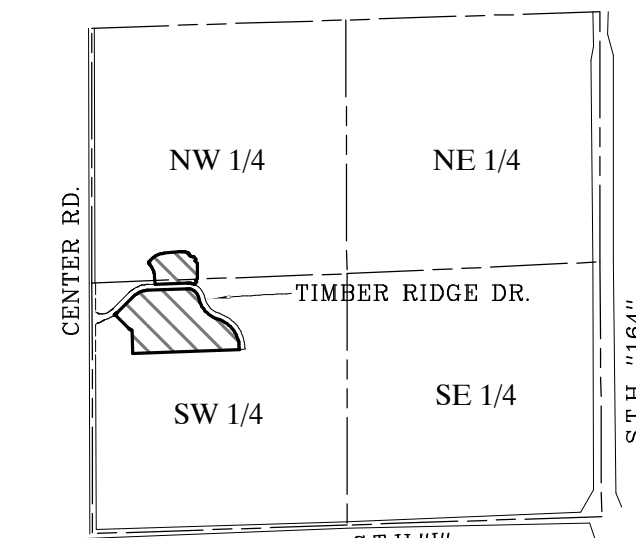

SEC. 22-6-19  
 1"=2000'

**BUILDING SETBACKS**

Lot	front	side	rear
1-10	25	10	75
11-14	25	10	40
15	25	10	40/75
16-18	25	10	75
19-29	25	10	40
30	25	10	75
31	25	10	45
32-35	40	10	50
36	40	10	40/50
37	40	10	40

## TYPICAL SIDEWALK CORNER EASEMENT (SCE)

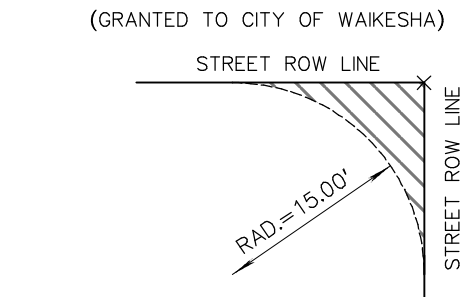

There are no objections to this plat with respect to  
 Secs. 236.15, 236.16, 236.20 and 236.21(1) and (2),  
 Wis. Stats. as provided by s. 236.12, Wis. Stats.

Certified \_\_\_\_\_, 20\_\_

Department of Administration

## LEGEND:

- X - Chiseled (X) on concrete set
  - o - 1 1/4" X 18" Iron Rod Weighing 4.17 lbs/ft set
  - - 3/4" Iron Rod Found
- All Other Lot, Outlot and Meander Corners  
 3/4" X 18" Iron Rod 1.50 lbs/in ft Set

ALL LINEAL MEASUREMENTS HAVE BEEN MADE TO THE NEAREST ONE-HUNDREDTH  
 OF A FOOT. ALL ANGULAR MEASUREMENTS HAVE BEEN MADE TO THE NEAREST  
 SECOND AND COMPUTED TO THE NEAREST ONE-HALF SECOND.

## NOTES:

1. THE SIDEWALK LOCATED IN THE EASEMENT ON LOTS 33-35  
 WILL BE MAINTAINED BY THE TIMBERVIEW ESTATES  
 HOMEOWNERS ASSOCIATION.
2. THERE SHALL BE A 10 FOOT WIDE TEMPORARY SLOPE EASEMENT  
 ACROSS THE BENNETT DRIVE FRONTAGE OF LOTS 1-11, 14-22  
 AND ACROSS MARIE CIRCLE FRONTAGE OF LOTS 32-37, SAID  
 EASEMENT TO BE IN EFFECT UNTIL SIDEWALK IS INSTALLED.
3. THE WATERMAIN AND STORM SEWER EASEMENTS SHOWN ARE RECORDED  
 ON CSM NO. 9681 AND AMENDED IN AFFIDAVIT OF CORRECTION  
 RECORDED IN DOCUMENT NO. 3203488.
4. PART OF THE LANDS IN THIS SUBDIVISION WERE TERMINATED AS  
 PART OF COTTAGES AT TIMBER RIDGE CONDOMINIUM IN DOCUMENT  
 NUMBERS 3833819, 3833820, 3833821 AND 3833822.
5. LOTS 32-36 SHALL HAVE NO ACCESS TO THE PRIVATE DRIVES  
 (ELISE DRIVE AND ELISE COURT)

BASEMENT RESTRICTION - GROUNDWATER  
 Although all lots in the Subdivision have been reviewed and approved for development with  
 single-family residential use in accordance with Section 236 Wisconsin Statutes, some lots  
 contain soil conditions that, due to the possible presence of groundwater near the surface, may  
 require additional soil engineering and foundation design with regard to basement construction.  
 It is recommended that either a licensed professional engineer or other soils expert design a  
 basement and foundation that will be suitable to withstand the various problems associated with  
 saturated soil conditions on basement walls or floors or that other special measures be taken. Soil  
 conditions should be subject to each owner's special investigation prior to construction and no  
 specific representation is made herein.

- EASEMENT NOTES:**
1. No building or fence shall be constructed in sanitary sewer, storm sewer, drainage and water main-easements. No trees or  
 bushes which would grow to more than 4' in height shall be planted within said easement without approval of the City of  
 Waukesha Engineering Department and the Waukesha Water Utility.
  2. In the event the water utility finds it necessary to disturb the premises in the exercise of its duties and responsibilities (future  
 repairs, if necessary), The Utility agrees to restore the premises of the Grantor, as nearly as is reasonably possible, to the  
 condition existing prior to such disturbance, however, not including the replacement of pavement, trees, shrubbery and other  
 items existing on or within the described easement.
  3. Grade changes within the Permanent Water Main Easements which exceed 12" (one foot) shall not be made without prior  
 written approval of the Waukesha Water Utility.



DATED THIS 16TH DAY OF MAY, 2011.  
 REV. 5/31/11  
 REV. 7/22/11  
 REV. 9/6/11  
 REV. 3/11/11

**KW SURVEYING, INC.**  
 725 PALMYRA STREET  
 P.O. BOX 32  
 Sullivan, WI. 53178  
 (262)-593-5800

THIS INSTRUMENT WAS DRAFTED BY KENNETH J. WILKOWSKI, S-1841

SHEET 1 OF 2

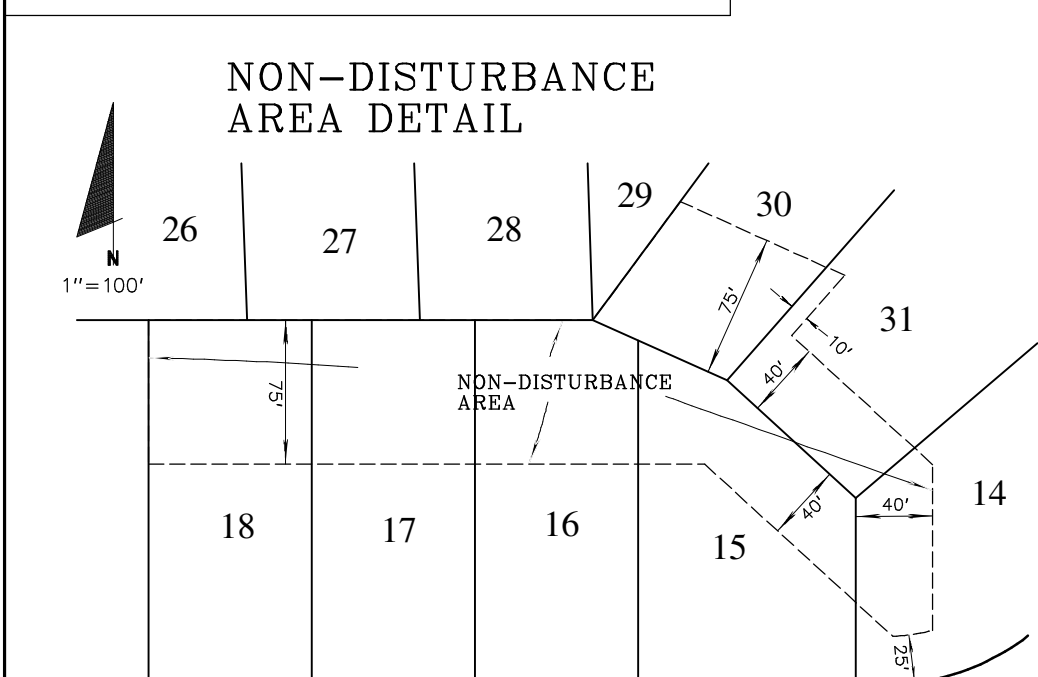
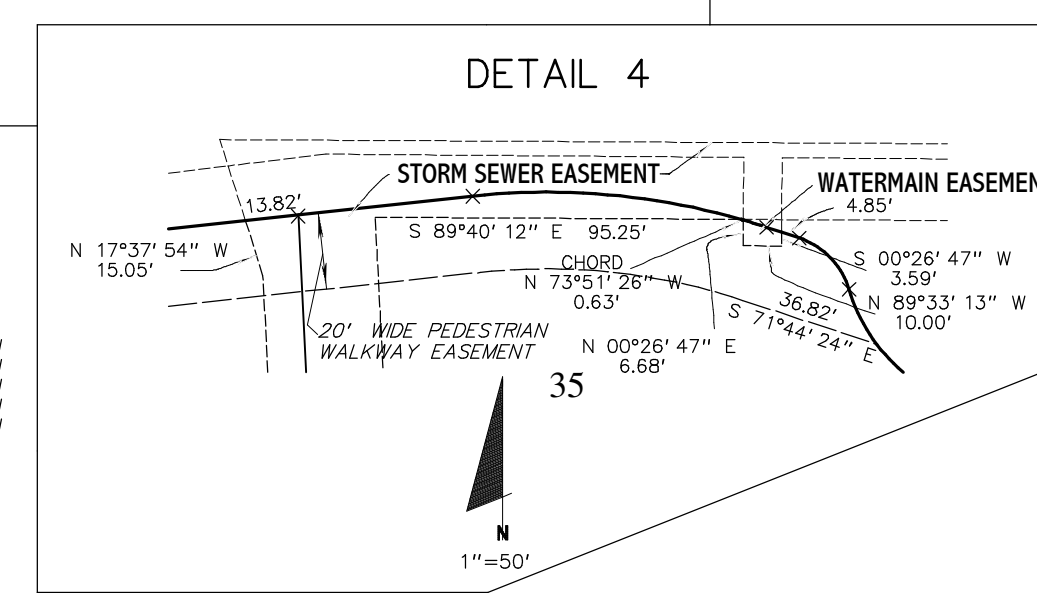
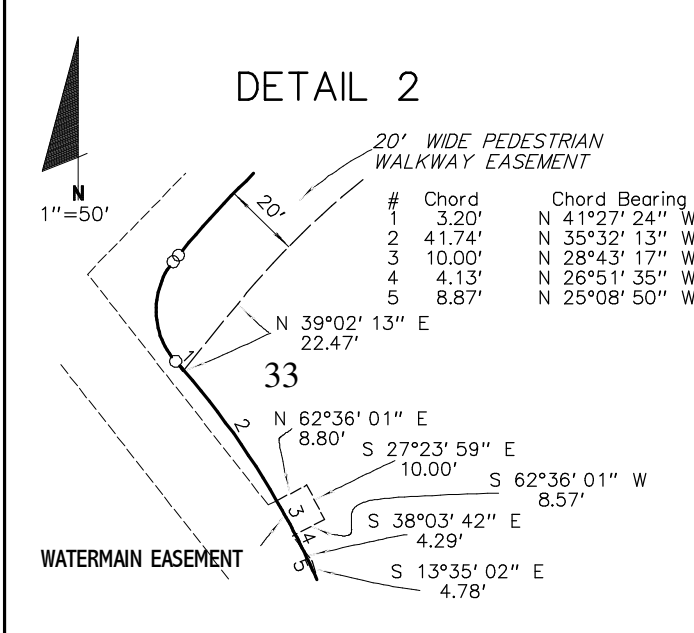
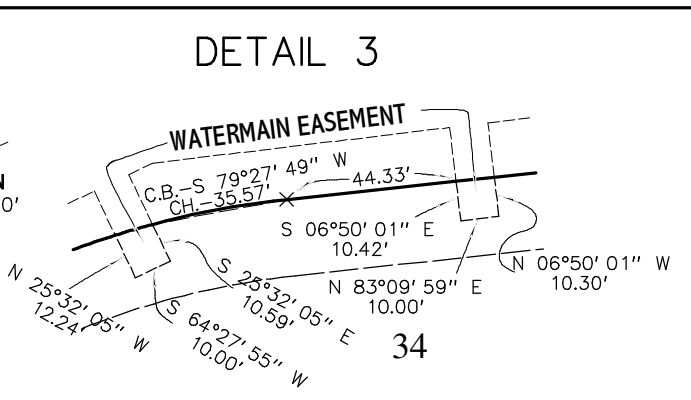
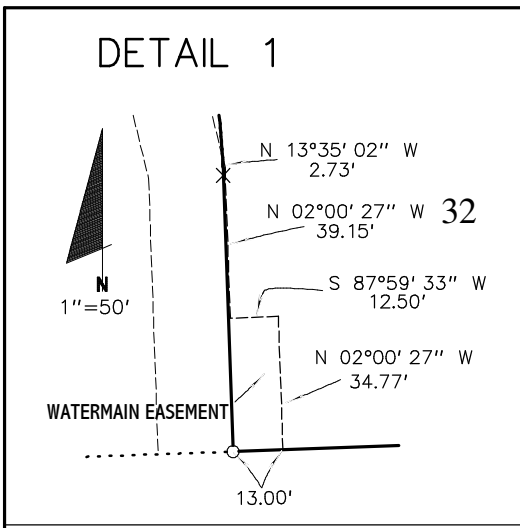

LOTS INCLUDED IN ISOLATED NATURAL RESOURCE AREA  
 SEE NOTE SHEET 2

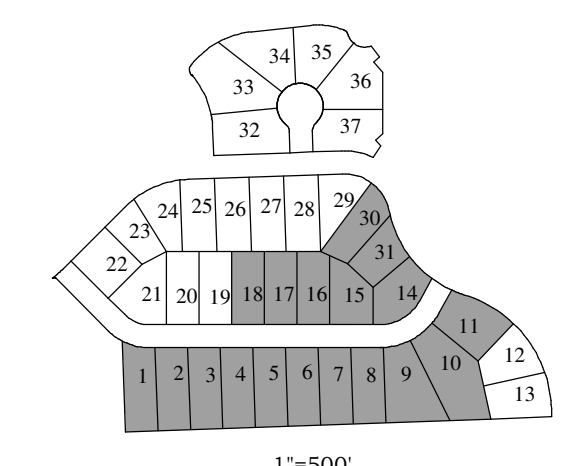

NW COR SW 1/4  
 SEC. 22-6-19  
 CONC. MONU  
 /BRASS CAP  
 N 357.119.82  
 E 2,469.035.42

SW COR SW 1/4  
 SEC. 22-6-19  
 CONC. MONU  
 /BRASS CAP  
 N 354.507.90  
 E 2,469.042.33