



# D-Series Size 1 LED Wall Luminaire



Catalog Number

Notes

Type

Hit the Tab key or mouse over the page to see all interactive elements.

d#series

## Specifications Luminaire

<b>Width:</b>	13-3/4" (34.9 cm)	<b>Weight:</b>	12 lbs (5.4 kg)
<b>Depth:</b>	10" (25.4 cm)		
<b>Height:</b>	6-3/8" (16.2 cm)		

## Back Box (BBW, ELCW)

<b>Width:</b>	13-3/4" (34.9 cm)	<b>BBW Weight:</b>	5 lbs (2.3 kg)
<b>Depth:</b>	4" (10.2 cm)	<b>ELCW Weight:</b>	10 lbs (4.5 kg)
<b>Height:</b>	6-3/8" (16.2 cm)		

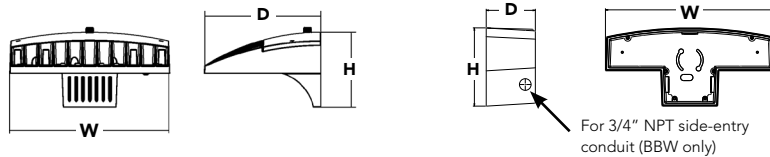

## Introduction

The D-Series Wall luminaire is a stylish, fully integrated LED solution for building-mount applications. It features a sleek, modern design and is carefully engineered to provide long-lasting, energy-efficient lighting with a variety of optical and control options for customized performance.

With an expected service life of over 20 years of nighttime use and up to 74% in energy savings over comparable 250W metal halide luminaires, the D-Series Wall is a reliable, low-maintenance lighting solution that produces sites that are exceptionally illuminated.

## Ordering Information

EXAMPLE: DSXW1 LED 20C 1000 40K T3M MVOLT DBBTD

Series	LEDs	Drive Current	Color temperature	Distribution	Voltage	Mounting	Control Options
<b>DSXW1 LED</b>	<b>10C</b> 10 LEDs (one engine) <b>20C</b> 20 LEDs (two engines) <sup>1</sup>	<b>350</b> 350 mA <b>530</b> 530 mA <b>700</b> 700 mA <b>1000</b> 1000 mA (1 A) <sup>1</sup>	<b>30K</b> 3000 K <b>40K</b> 4000 K <b>50K</b> 5000 K <b>AMBPC</b> Amber phosphor converted	<b>T2S</b> Type II Short <b>T2M</b> Type II Medium <b>T3S</b> Type III Short <b>T3M</b> Type III Medium <b>T4M</b> Type IV Medium <b>TFTM</b> Forward Throw Medium	<b>MVOLT</b> <sup>2</sup> <b>120</b> <sup>3</sup> <b>208</b> <sup>3</sup> <b>240</b> <sup>3</sup> <b>277</b> <sup>3</sup> <b>347</b> <sup>3,4</sup> <b>480</b> <sup>3,4</sup>	<b>Shipped included</b> (blank) Surface mounting bracket <b>BBW</b> Surface-mounted back box (for conduit entry) <sup>5</sup>	<b>Shipped installed</b> <b>PE</b> Photoelectric cell, button type <sup>6</sup> <b>DMG</b> 0-10v dimming wires pulled outside fixture (for use with an external control, ordered separately) <b>PIR</b> 180° motion/ambient light sensor, <15' mtg ht <sup>1,7</sup> <b>PIRH</b> 180° motion/ambient light sensor, 15-30' mtg ht <sup>1,7</sup> <b>PIR1FC3V</b> Motion/ambient sensor, 8-15' mounting height, ambient sensor enabled at 1fc <sup>1,7</sup> <b>PIRH1FC3V</b> Motion/ambient sensor, 15-30' mounting height, ambient sensor enabled at 1fc <sup>1,7</sup> <b>ELCW</b> Emergency battery backup (includes external component enclosure), CA Title 20 Noncompliant <sup>8,9</sup>

### Other Options

### Finish (required)

#### Shipped installed

<b>SF</b> Single fuse (120, 277 or 347V) <sup>3,10</sup>	<b>DF</b> Double fuse (208, 240 or 480V) <sup>3,10</sup>	<b>HS</b> House-side shield <sup>11</sup>	<b>SPD</b> Separate surge protection <sup>12</sup>
--	--	---	--

#### Shipped separately<sup>11</sup>

<b>BSW</b> Bird-deterrent spikes	<b>WG</b> Wire guard	<b>VG</b> Vandal guard	<b>DDL</b> Diffused drop lens
----------------------------------	----------------------	------------------------	-------------------------------

<b>DDBXD</b> Dark bronze	<b>DBLXD</b> Black	<b>DNAXD</b> Natural aluminum	<b>DWHXD</b> White
<b>DSSXD</b> Sandstone	<b>DBBTD</b> Textured dark bronze	<b>DBLBXD</b> Textured black	<b>DNATXD</b> Textured natural aluminum

<b>DWHGXD</b> Textured white	<b>DSSTXD</b> Textured sandstone
------------------------------	----------------------------------

## Accessories

Ordered and shipped separately.

DSXWHS U	House-side shield (one per light engine)
DSXWBSW U	Bird-deterrent spikes
DSXW1WG U	Wire guard accessory
DSXW1VG U	Vandal guard accessory

### NOTES

- 20C 1000 is not available with PIR, PIRH, PIR1FC3V or PIRH1FC3V.
- MVOLT driver operates on any line voltage from 120-277V (50/60 Hz).
- Single fuse (SF) requires 120, 277 or 347 voltage option. Double fuse (DF) requires 208, 240 or 480 voltage option.
- Only available with 20C, 700mA or 1000mA. Not available with PIR or PIRH.
- Back box ships installed on fixture. Cannot be field installed. Cannot be ordered as an accessory.
- Photocontrol (PE) requires 120, 208, 240, 277 or 347 voltage option. Not available with motion/ambient light sensors (PIR or PIRH).
- Reference Motion Sensor table on page 3.
- Cold weather (-20C) rated. Not compatible with conduit entry applications. Not available with BBW mounting option. Not available with fusing. Not available with 347 or 480 voltage options. Emergency components located in back box housing. Emergency mode IES files located on product page at [www.lithonia.com](http://www.lithonia.com)
- Not available with SPD.
- Not available with ELCW.
- Also available as a separate accessory; see Accessories information.
- Not available with ELCW.



# Performance Data

## Lumen Output

Lumen values are from photometric tests performed in accordance with IESNA LM-79-08. Data is considered to be representative of the configurations shown, within the tolerances allowed by Lighting Facts. Contact factory for performance data on any configurations not shown here.

LEDs	Drive Current (mA)	System Watts	Dist. Type	30K (3000 K, 70CRI)					40K (4000 K, 70CRI)					50K (5000 K, 70CRI)					AMBPC (Amber Phosphor Converted)				
				Lumens	B	U	G	LPW	Lumens	B	U	G	LPW	Lumens	B	U	G	LPW	Lumens	B	U	G	LPW
(10 LEDs)	350mA	13W	T2S	1,415	0	0	1	109	1,520	0	0	1	117	1,530	0	0	1	118	894	0	0	1	69
			T2M	1,349	0	0	1	104	1,448	0	0	1	111	1,458	0	0	1	112	852	0	0	1	66
			T3S	1,399	0	0	1	108	1,503	0	0	1	116	1,512	0	0	1	116	884	0	0	1	68
			T3M	1,385	0	0	1	107	1,488	0	0	1	114	1,497	0	0	1	115	876	0	0	1	67
			T4M	1,357	0	0	1	104	1,458	0	0	1	112	1,467	0	0	1	113	858	0	0	1	66
			TFTM	1,411	0	0	1	109	1,515	0	0	1	117	1,525	0	0	1	117	892	0	0	1	69
	ASDYF	1,262	1	0	1	97	1,354	1	0	1	104	1,363	1	0	1	105	797	0	0	1	61		
	530 mA	19W	T2S	2,053	1	0	1	108	2,205	1	0	1	116	2,220	1	0	1	117	1,264	0	0	1	67
			T2M	1,957	1	0	1	103	2,102	1	0	1	111	2,115	1	0	1	111	1,205	0	0	1	63
			T3S	2,031	1	0	1	107	2,181	1	0	1	115	2,194	1	0	1	115	1,250	0	0	1	66
			T3M	2,010	1	0	1	106	2,159	1	0	1	114	2,172	1	0	1	114	1,237	0	0	1	65
			T4M	1,970	1	0	1	104	2,115	1	0	1	111	2,129	1	0	1	112	1,212	0	0	1	64
			TFTM	2,047	0	0	1	108	2,198	1	0	1	116	2,212	1	0	1	116	1,260	0	0	1	66
	ASDYF	1,831	1	0	1	96	1,966	1	0	1	103	1,978	1	0	1	104	1,127	0	0	1	59		
	700 mA	26W	T2S	2,623	1	0	1	101	2,816	1	0	1	108	2,834	1	0	1	109	1,544	0	0	1	59
			T2M	2,499	1	0	1	96	2,684	1	0	1	103	2,701	1	0	1	104	1,472	0	0	1	57
			T3S	2,593	1	0	1	100	2,785	1	0	1	107	2,802	1	0	1	108	1,527	0	0	1	59
			T3M	2,567	1	0	1	99	2,757	1	0	1	106	2,774	1	0	1	107	1,512	0	0	1	58
			T4M	2,515	1	0	1	97	2,701	1	0	1	104	2,718	1	0	1	105	1,481	0	0	1	57
			TFTM	2,614	1	0	1	101	2,808	1	0	1	108	2,825	1	0	1	109	1,539	0	0	1	59
	ASDYF	2,337	1	0	1	90	2,510	1	0	1	97	2,525	1	0	1	97	1,376	1	0	1	53		
	1000 mA	39W	T2S	3,685	1	0	1	94	3,957	1	0	1	101	3,982	1	0	1	102	2,235	1	0	1	57
			T2M	3,512	1	0	1	90	3,771	1	0	1	97	3,794	1	0	1	97	2,130	1	0	1	55
			T3S	3,644	1	0	1	93	3,913	1	0	1	100	3,938	1	0	1	101	2,210	1	0	1	57
T3M			3,607	1	0	1	92	3,873	1	0	1	99	3,898	1	0	1	100	2,187	1	0	1	56	
T4M			3,534	1	0	2	91	3,796	1	0	2	97	3,819	1	0	2	98	2,143	1	0	1	55	
TFTM			3,673	1	0	1	94	3,945	1	0	1	101	3,969	1	0	1	102	2,228	1	0	1	57	
ASDYF	3,284	1	0	2	84	3,527	1	0	2	90	3,549	1	0	2	91	1,992	1	0	1	51			
(20 LEDs)	350mA	23W	T2S	2,820	1	0	1	123	3,028	1	0	1	132	3,047	1	0	1	132	1,777	1	0	1	77
			T2M	2,688	1	0	1	117	2,886	1	0	1	125	2,904	1	0	1	126	1,693	1	0	1	74
			T3S	2,789	1	0	1	121	2,994	1	0	1	130	3,014	1	0	1	131	1,757	0	0	1	76
			T3M	2,760	1	0	1	120	2,965	1	0	1	129	2,983	1	0	1	130	1,739	1	0	1	76
			T4M	2,704	1	0	1	118	2,905	1	0	1	126	2,922	1	0	1	127	1,704	1	0	1	74
			TFTM	2,811	1	0	1	122	3,019	1	0	1	131	3,038	1	0	1	132	1,771	0	0	1	77
	ASDYF	2,514	1	0	1	109	2,699	1	0	1	117	2,716	1	0	1	118	1,584	1	0	1	69		
	530 mA	35W	T2S	4,079	1	0	1	117	4,380	1	0	1	125	4,407	1	0	1	126	2,504	1	0	1	72
			T2M	3,887	1	0	1	111	4,174	1	0	1	119	4,201	1	0	1	120	2,387	1	0	1	68
			T3S	4,033	1	0	1	115	4,331	1	0	1	124	4,359	1	0	1	125	2,477	1	0	1	71
			T3M	3,993	1	0	2	114	4,288	1	0	2	123	4,315	1	0	2	123	2,451	1	0	1	70
			T4M	3,912	1	0	2	112	4,201	1	0	2	120	4,227	1	0	2	121	2,402	1	0	1	69
			TFTM	4,066	1	0	2	116	4,366	1	0	2	125	4,394	1	0	2	126	2,496	1	0	1	71
	ASDYF	3,636	1	0	2	104	3,904	1	0	2	112	3,928	1	0	2	112	2,232	1	0	1	64		
	700 mA	46W	T2S	5,188	1	0	1	113	5,572	1	0	1	121	5,607	1	0	1	122	3,065	1	0	1	67
			T2M	4,945	1	0	2	108	5,309	1	0	2	115	5,343	1	0	2	116	2,921	1	0	1	64
			T3S	5,131	1	0	2	112	5,510	1	0	2	120	5,544	1	0	2	121	3,031	1	0	1	66
			T3M	5,078	1	0	2	110	5,454	1	0	2	119	5,487	1	0	2	119	3,000	1	0	1	65
			T4M	4,975	1	0	2	108	5,343	1	0	2	116	5,376	1	0	2	117	2,939	1	0	1	64
			TFTM	5,172	1	0	2	112	5,554	1	0	2	121	5,589	1	0	2	122	3,055	1	0	1	66
	ASDYF	4,624	1	0	2	101	4,965	1	0	2	108	4,996	1	0	2	109	2,732	1	0	1	59		
	1000 mA	73W	T2S	7,204	1	0	2	99	7,736	2	0	2	106	7,784	2	0	2	107	4,429	1	0	1	61
			T2M	6,865	1	0	2	94	7,373	2	0	2	101	7,419	2	0	2	102	4,221	1	0	1	58
			T3S	7,125	1	0	2	98	7,651	1	0	2	105	7,698	1	0	2	105	4,380	1	0	1	60
T3M			7,052	1	0	2	97	7,573	2	0	2	104	7,620	2	0	2	104	4,335	1	0	2	59	
T4M			6,909	1	0	2	95	7,420	1	0	2	102	7,466	1	0	2	102	4,248	1	0	2	58	
TFTM			7,182	1	0	2	98	7,712	1	0	2	106	7,761	1	0	2	106	4,415	1	0	2	60	
ASDYF	6,421	2	0	2	88	6,896	2	0	3	94	6,938	2	0	3	95	3,947	1	0	2	54			

## Performance Data

### Lumen Ambient Temperature (LAT) Multipliers

Use these factors to determine relative lumen output for average ambient temperatures from 0-40°C (32-104°F).

Ambient		Lumen Multiplier
0°C	32°F	1.02
10°C	50°F	1.01
20°C	68°F	1.00
25°C	77°F	1.00
30°C	86°F	1.00
40°C	104°F	0.98

### Projected LED Lumen Maintenance

Data references the extrapolated performance projections for the DSXW1 LED 20C 1000 platform in a 25°C ambient, based on 10,000 hours of LED testing (tested per IESNA LM-80-08 and projected per IESNA TM-21-11).

To calculate LLF, use the lumen maintenance factor that corresponds to the desired number of operating hours below. For other lumen maintenance values, contact factory.

Operating Hours	0	25,000	50,000	100,000
Lumen Maintenance Factor	1.0	0.95	0.93	0.88

### Electrical Load

LEDs	Drive Current (mA)	System Watts	Current (A)					
			120V	208V	240V	277V	347V	480V
10C	350	14 W	0.13	0.07	0.06	0.06	-	-
	530	20 W	0.19	0.11	0.09	0.08	-	-
	700	27 W	0.25	0.14	0.13	0.11	-	-
	1000	40 W	0.37	0.21	0.19	0.16	-	-
20C	350	24 W	0.23	0.13	0.12	0.10	-	-
	530	36 W	0.33	0.19	0.17	0.14	-	-
	700	47 W	0.44	0.25	0.22	0.19	0.15	0.11
	1000	74 W	0.69	0.40	0.35	0.30	0.23	0.17

### Motion Sensor Default Settings

Option	Dimmed State	High Level (when triggered)	Photocell Operation	Dwell Time	Ramp-up Time	Ramp-down Time
*PIR or PIRH	3V (37%) Output	10V (100%) Output	Enabled @ 5FC	5 min	3 sec	5 min
PIR1FC3V or PIRH1FC3V	3V (37%) Output	10V (100%) Output	Enabled @ 1FC	5 min	3 sec	5 min

\*for use with Inline Dusk to Dawn or timer

## Photometric Diagrams

To see complete photometric reports or download .ies files for this product, visit Lithonia Lighting's [D-Series Wall Size 1 homepage](#).

Isofootcandle plots for the DSXW1 LED 20C 1000 40K. Distances are in units of mounting height (15').

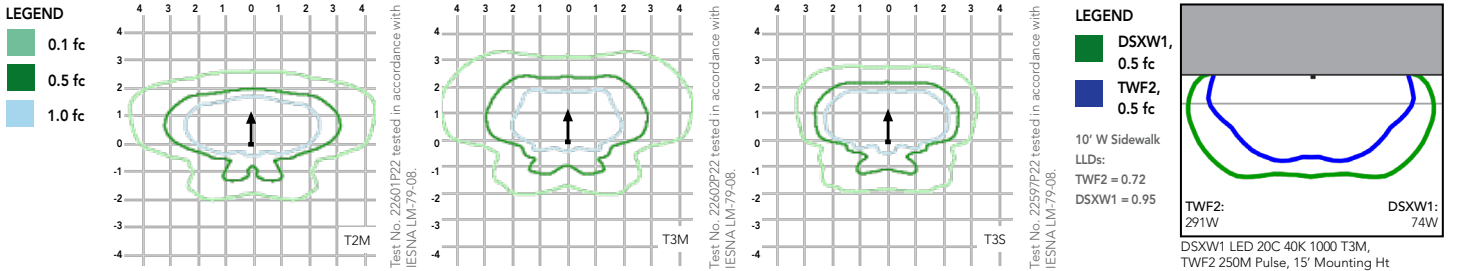

## Options and Accessories



T3M (left), ASYDF (right) lenses



HS - House-side shields



BSW - Bird-deterrent spikes



WG - Wire guard



VG - Vandal guard



DDL - Diffused drop lens

## FEATURES & SPECIFICATIONS

### INTENDED USE

The energy savings, long life and easy-to-install design of the D-Series Wall Size 1 make it the smart choice for building-mounted doorway and pathway illumination for nearly any facility.

### CONSTRUCTION

Two-piece die-cast aluminum housing has integral heat sink fins to optimize thermal management through conductive and convective cooling. Modular design allows for ease of maintenance. The LED driver is mounted to the door to thermally isolate it from the light engines for low operating temperature and long life. Housing is completely sealed against moisture and environmental contaminants (IP65).

### FINISH

Exterior parts are protected by a zinc-infused Super Durable TGIC thermoset powder coat finish that provides superior resistance to corrosion and weathering. A tightly controlled multi-stage process ensures a minimum 3 mils thickness for a finish that can withstand extreme climate changes without cracking or peeling. Available in textured and non-textured finishes.

### OPTICS

Precision-molded proprietary acrylic lenses provide multiple photometric distributions tailored specifically to building mounted applications. Light engines are available in 3000 K (70 min. CRI), 4000 K (70 min. CRI) or 5000 K (70 min. CRI) configurations.

### ELECTRICAL

Light engine(s) consist of 10 high-efficacy LEDs mounted to a metal-core circuit board to maximize heat dissipation and promote long life (L88/100,000 hrs at 25°C). Class 1 electronic drivers have a power factor >90%, THD <20%, and a minimum 2.5KV surge rating. When ordering the SPD option, a separate surge protection device is installed within the luminaire which meets a minimum Category C Low (per ANSI/IEEE C62.41.2).

### INSTALLATION

Included universal mounting bracket attaches securely to any 4" round or square outlet box for quick and easy installation. Luminaire has a slotted gasket wireway and attaches to the mounting bracket via corrosion-resistant screws.

### LISTINGS

CSA certified to U.S. and Canadian standards. Rated for -40°C minimum ambient.

DesignLights Consortium® (DLC) qualified product. Not all versions of this product may be DLC qualified. Please check the DLC Qualified Products List at [www.designlights.org/QPL](http://www.designlights.org/QPL) to confirm which versions are qualified.

### WARRANTY

Five-year limited warranty. Complete warranty terms located at: [www.acuitybrands.com/resources/terms-and-conditions](http://www.acuitybrands.com/resources/terms-and-conditions)

**Note:** Actual performance may differ as a result of end-user environment and application. All values are design or typical values, measured under laboratory conditions at 25 °C. Specifications subject to change without notice.





# D-Series Size 1 LED Wall Luminaire



Catalog Number

Notes

Type

Hit the Tab key or mouse over the page to see all interactive elements.

d#series

## Specifications Luminaire

<b>Width:</b>	13-3/4" (34.9 cm)	<b>Weight:</b>	12 lbs (5.4 kg)
<b>Depth:</b>	10" (25.4 cm)		
<b>Height:</b>	6-3/8" (16.2 cm)		

## Back Box (BBW, ELCW)

<b>Width:</b>	13-3/4" (34.9 cm)	<b>BBW Weight:</b>	5 lbs (2.3 kg)
<b>Depth:</b>	4" (10.2 cm)	<b>ELCW Weight:</b>	10 lbs (4.5 kg)
<b>Height:</b>	6-3/8" (16.2 cm)		

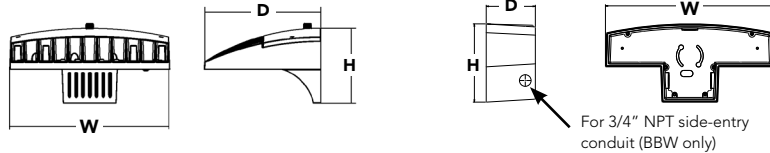

## Introduction

The D-Series Wall luminaire is a stylish, fully integrated LED solution for building-mount applications. It features a sleek, modern design and is carefully engineered to provide long-lasting, energy-efficient lighting with a variety of optical and control options for customized performance.

With an expected service life of over 20 years of nighttime use and up to 74% in energy savings over comparable 250W metal halide luminaires, the D-Series Wall is a reliable, low-maintenance lighting solution that produces sites that are exceptionally illuminated.

## Ordering Information

EXAMPLE: DSXW1 LED 20C 1000 40K T3M MVOLT DBBTD

Series	LEDs	Drive Current	Color temperature	Distribution	Voltage	Mounting	Control Options
<b>DSXW1 LED</b>	<b>10C</b> 10 LEDs (one engine) <b>20C</b> 20 LEDs (two engines) <sup>1</sup>	350 350 mA 530 530 mA <b>700</b> 700 mA 1000 1000 mA (1 A) <sup>1</sup>	30K 3000 K 40K 4000 K <b>50K</b> 5000 K AMBPC Amber phosphor converted	T2S Type II Short T2M Type II Medium T3S Type III Short <b>T3M</b> Type III Medium T4M Type IV Medium TFTM Forward Throw Medium	<b>MVOLT</b> <sup>2</sup> 120 <sup>3</sup> 208 <sup>3</sup> 240 <sup>3</sup> 277 <sup>3</sup> 347 <sup>3,4</sup> 480 <sup>3,4</sup>	<b>Shipped included</b> (blank) Surface mounting bracket <b>BBW</b> Surface-mounted back box (for conduit entry) <sup>5</sup>	<b>Shipped installed</b> PE Photoelectric cell, button type <sup>6</sup> DMG 0-10v dimming wires pulled outside fixture (for use with an external control, ordered separately) PIR 180° motion/ambient light sensor, <15' mtg ht <sup>1,7</sup> PIRH 180° motion/ambient light sensor, 15-30' mtg ht <sup>1,7</sup> PIR1FC3V Motion/ambient sensor, 8-15' mounting height, ambient sensor enabled at 1fc <sup>1,7</sup> PIRH1FC3V Motion/ambient sensor, 15-30' mounting height, ambient sensor enabled at 1fc <sup>1,7</sup> ELCW Emergency battery backup (includes external component enclosure), CA Title 20 Noncompliant <sup>8,9</sup>

Other Options	Finish (required)
<b>Shipped installed</b> SF Single fuse (120, 277 or 347V) <sup>3,10</sup> DF Double fuse (208, 240 or 480V) <sup>3,10</sup> HS House-side shield <sup>11</sup> SPD Separate surge protection <sup>12</sup>	DDBXD Dark bronze DBLXD Black DNAXD Natural aluminum DWHXD White DSSXD Sandstone DBBTD Textured dark bronze DBLBXD Textured black DNATXD Textured natural aluminum DWHGXD Textured white DSSTXD Textured sandstone

## Accessories

Ordered and shipped separately.

DSXWHS U	House-side shield (one per light engine)
DSXWBSW U	Bird-deterrent spikes
DSXW1WG U	Wire guard accessory
DSXW1VG U	Vandal guard accessory

## NOTES

- 20C 1000 is not available with PIR, PIRH, PIR1FC3V or PIRH1FC3V.
- MVOLT driver operates on any line voltage from 120-277V (50/60 Hz).
- Single fuse (SF) requires 120, 277 or 347 voltage option. Double fuse (DF) requires 208, 240 or 480 voltage option.
- Only available with 20C, 700mA or 1000mA. Not available with PIR or PIRH.
- Back box ships installed on fixture. Cannot be field installed. Cannot be ordered as an accessory.
- Photocontrol (PE) requires 120, 208, 240, 277 or 347 voltage option. Not available with motion/ambient light sensors (PIR or PIRH).
- Reference Motion Sensor table on page 3.
- Cold weather (-20C) rated. Not compatible with conduit entry applications. Not available with BBW mounting option. Not available with fusing. Not available with 347 or 480 voltage options. Emergency components located in back box housing. Emergency mode IES files located on product page at [www.lithonia.com](http://www.lithonia.com)
- Not available with SPD.
- Not available with ELCW.
- Also available as a separate accessory; see Accessories information.
- Not available with ELCW.





# Performance Data

## Lumen Output

Lumen values are from photometric tests performed in accordance with IESNA LM-79-08. Data is considered to be representative of the configurations shown, within the tolerances allowed by Lighting Facts. Contact factory for performance data on any configurations not shown here.

LEDs	Drive Current (mA)	System Watts	Dist. Type	30K (3000 K, 70CRI)					40K (4000 K, 70CRI)					50K (5000 K, 70CRI)					AMBPC (Amber Phosphor Converted)				
				Lumens	B	U	G	LPW	Lumens	B	U	G	LPW	Lumens	B	U	G	LPW	Lumens	B	U	G	LPW
(10 LEDs)	350mA	13W	T2S	1,415	0	0	1	109	1,520	0	0	1	117	1,530	0	0	1	118	894	0	0	1	69
			T2M	1,349	0	0	1	104	1,448	0	0	1	111	1,458	0	0	1	112	852	0	0	1	66
			T3S	1,399	0	0	1	108	1,503	0	0	1	116	1,512	0	0	1	116	884	0	0	1	68
			T3M	1,385	0	0	1	107	1,488	0	0	1	114	1,497	0	0	1	115	876	0	0	1	67
			T4M	1,357	0	0	1	104	1,458	0	0	1	112	1,467	0	0	1	113	858	0	0	1	66
			TFTM	1,411	0	0	1	109	1,515	0	0	1	117	1,525	0	0	1	117	892	0	0	1	69
	530 mA	19W	ASYDF	1,262	1	0	1	97	1,354	1	0	1	104	1,363	1	0	1	105	797	0	0	1	61
			T2S	2,053	1	0	1	108	2,205	1	0	1	116	2,220	1	0	1	117	1,264	0	0	1	67
			T2M	1,957	1	0	1	103	2,102	1	0	1	111	2,115	1	0	1	111	1,205	0	0	1	63
			T3S	2,031	1	0	1	107	2,181	1	0	1	115	2,194	1	0	1	115	1,250	0	0	1	66
			T3M	2,010	1	0	1	106	2,159	1	0	1	114	2,172	1	0	1	114	1,237	0	0	1	65
			T4M	1,970	1	0	1	104	2,115	1	0	1	111	2,129	1	0	1	112	1,212	0	0	1	64
	700 mA	26W	TFTM	2,047	0	0	1	108	2,198	1	0	1	116	2,212	1	0	1	116	1,260	0	0	1	66
			ASYDF	1,831	1	0	1	96	1,966	1	0	1	103	1,978	1	0	1	104	1,127	0	0	1	59
			T2S	2,623	1	0	1	101	2,816	1	0	1	108	2,834	1	0	1	109	1,544	0	0	1	59
			T2M	2,499	1	0	1	96	2,684	1	0	1	103	2,701	1	0	1	104	1,472	0	0	1	57
			T3S	2,593	1	0	1	100	2,785	1	0	1	107	2,802	1	0	1	108	1,527	0	0	1	59
			T3M	2,567	1	0	1	99	2,757	1	0	1	106	2,774	1	0	1	107	1,512	0	0	1	58
	1000 mA	39W	T4M	2,515	1	0	1	97	2,701	1	0	1	104	2,718	1	0	1	105	1,481	0	0	1	57
			TFTM	2,614	1	0	1	101	2,808	1	0	1	108	2,825	1	0	1	109	1,539	0	0	1	59
			ASYDF	2,337	1	0	1	90	2,510	1	0	1	97	2,525	1	0	1	97	1,376	1	0	1	53
			T2S	3,685	1	0	1	94	3,957	1	0	1	101	3,982	1	0	1	102	2,235	1	0	1	57
			T2M	3,512	1	0	1	90	3,771	1	0	1	97	3,794	1	0	1	97	2,130	1	0	1	55
			T3S	3,644	1	0	1	93	3,913	1	0	1	100	3,938	1	0	1	101	2,210	1	0	1	57
(20 LEDs)	350mA	23W	T3M	3,607	1	0	1	92	3,873	1	0	1	99	3,898	1	0	1	100	2,187	1	0	1	56
			T4M	3,534	1	0	2	91	3,796	1	0	2	97	3,819	1	0	2	98	2,143	1	0	1	55
			TFTM	3,673	1	0	1	94	3,945	1	0	1	101	3,969	1	0	1	102	2,228	1	0	1	57
			ASYDF	3,284	1	0	2	84	3,527	1	0	2	90	3,549	1	0	2	91	1,992	1	0	1	51
			T2S	2,820	1	0	1	123	3,028	1	0	1	132	3,047	1	0	1	132	1,777	1	0	1	77
			T2M	2,688	1	0	1	117	2,886	1	0	1	125	2,904	1	0	1	126	1,693	1	0	1	74
	530 mA	35W	T3S	2,789	1	0	1	121	2,994	1	0	1	130	3,014	1	0	1	131	1,757	0	0	1	76
			T3M	2,760	1	0	1	120	2,965	1	0	1	129	2,983	1	0	1	130	1,739	1	0	1	76
			T4M	2,704	1	0	1	118	2,905	1	0	1	126	2,922	1	0	1	127	1,704	1	0	1	74
			TFTM	2,811	1	0	1	122	3,019	1	0	1	131	3,038	1	0	1	132	1,771	0	0	1	77
			ASYDF	2,514	1	0	1	109	2,699	1	0	1	117	2,716	1	0	1	118	1,584	1	0	1	69
			T2S	4,079	1	0	1	117	4,380	1	0	1	125	4,407	1	0	1	126	2,504	1	0	1	72
	700 mA	46W	T2M	3,887	1	0	1	111	4,174	1	0	1	119	4,201	1	0	1	120	2,387	1	0	1	68
			T3S	4,033	1	0	1	115	4,331	1	0	1	124	4,359	1	0	1	125	2,477	1	0	1	71
			T3M	3,993	1	0	2	114	4,288	1	0	2	123	4,315	1	0	2	123	2,451	1	0	1	70
			T4M	3,912	1	0	2	112	4,201	1	0	2	120	4,227	1	0	2	121	2,402	1	0	1	69
			TFTM	4,066	1	0	2	116	4,366	1	0	2	125	4,394	1	0	2	126	2,496	1	0	1	71
			ASYDF	3,636	1	0	2	104	3,904	1	0	2	112	3,928	1	0	2	112	2,232	1	0	1	64
	1000 mA	73W	T2S	5,188	1	0	1	113	5,572	1	0	1	121	5,607	1	0	1	122	3,065	1	0	1	67
			T2M	4,945	1	0	2	108	5,309	1	0	2	115	5,343	1	0	2	116	2,921	1	0	1	64
			T3S	5,131	1	0	2	112	5,510	1	0	2	120	5,544	1	0	2	121	3,031	1	0	1	66
			T3M	5,078	1	0	2	110	5,454	1	0	2	119	5,487	1	0	2	119	3,000	1	0	1	65
			T4M	4,975	1	0	2	108	5,343	1	0	2	116	5,376	1	0	2	117	2,939	1	0	1	64
			TFTM	5,172	1	0	2	112	5,554	1	0	2	121	5,589	1	0	2	122	3,055	1	0	1	66
1000 mA	73W	ASYDF	4,624	1	0	2	101	4,965	1	0	2	108	4,996	1	0	2	109	2,732	1	0	1	59	
		T2S	7,204	1	0	2	99	7,736	2	0	2	106	7,784	2	0	2	107	4,429	1	0	1	61	
		T2M	6,865	1	0	2	94	7,373	2	0	2	101	7,419	2	0	2	102	4,221	1	0	1	58	
		T3S	7,125	1	0	2	98	7,651	1	0	2	105	7,698	1	0	2	105	4,380	1	0	1	60	
		T3M	7,052	1	0	2	97	7,573	2	0	2	104	7,620	2	0	2	104	4,335	1	0	2	59	
		T4M	6,909	1	0	2	95	7,420	1	0	2	102	7,466	1	0	2	102	4,248	1	0	2	58	
1000 mA	73W	TFTM	7,182	1	0	2	98	7,712	1	0	2	106	7,761	1	0	2	106	4,415	1	0	2	60	
		ASYDF	6,421	2	0	2	88	6,896	2	0	3	94	6,938	2	0	3	95	3,947	1	0	2	54	



## Performance Data

### Lumen Ambient Temperature (LAT) Multipliers

Use these factors to determine relative lumen output for average ambient temperatures from 0-40°C (32-104°F).

Ambient		Lumen Multiplier
0°C	32°F	1.02
10°C	50°F	1.01
20°C	68°F	1.00
25°C	77°F	1.00
30°C	86°F	1.00
40°C	104°F	0.98

### Projected LED Lumen Maintenance

Data references the extrapolated performance projections for the DSXW1 LED 20C 1000 platform in a 25°C ambient, based on 10,000 hours of LED testing (tested per IESNA LM-80-08 and projected per IESNA TM-21-11).

To calculate LLF, use the lumen maintenance factor that corresponds to the desired number of operating hours below. For other lumen maintenance values, contact factory.

Operating Hours	0	25,000	50,000	100,000
Lumen Maintenance Factor	1.0	0.95	0.93	0.88

### Electrical Load

LEDs	Drive Current (mA)	System Watts	Current (A)					
			120V	208V	240V	277V	347V	480V
10C	350	14 W	0.13	0.07	0.06	0.06	-	-
	530	20 W	0.19	0.11	0.09	0.08	-	-
	700	27 W	0.25	0.14	0.13	0.11	-	-
	1000	40 W	0.37	0.21	0.19	0.16	-	-
20C	350	24 W	0.23	0.13	0.12	0.10	-	-
	530	36 W	0.33	0.19	0.17	0.14	-	-
	700	47 W	0.44	0.25	0.22	0.19	0.15	0.11
	1000	74 W	0.69	0.40	0.35	0.30	0.23	0.17

### Motion Sensor Default Settings

Option	Dimmed State	High Level (when triggered)	Photocell Operation	Dwell Time	Ramp-up Time	Ramp-down Time
*PIR or PIRH	3V (37%) Output	10V (100%) Output	Enabled @ 5FC	5 min	3 sec	5 min
PIR1FC3V or PIRH1FC3V	3V (37%) Output	10V (100%) Output	Enabled @ 1FC	5 min	3 sec	5 min

\*for use with Inline Dusk to Dawn or timer

## Photometric Diagrams

To see complete photometric reports or download .ies files for this product, visit Lithonia Lighting's [D-Series Wall Size 1 homepage](#).

Isfootcandle plots for the DSXW1 LED 20C 1000 40K. Distances are in units of mounting height (15').

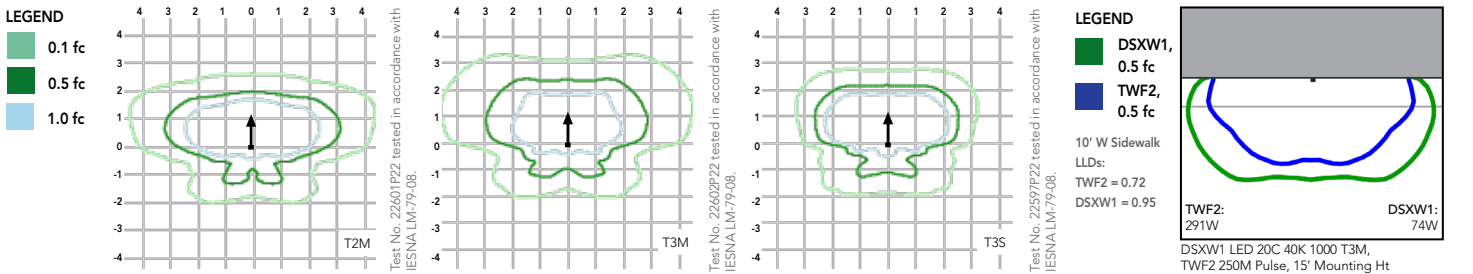

## Options and Accessories



T3M (left), ASYDF (right) lenses



HS - House-side shields



BSW - Bird-deterrent spikes



WG - Wire guard



VG - Vandal guard



DDL - Diffused drop lens

## FEATURES & SPECIFICATIONS

### INTENDED USE

The energy savings, long life and easy-to-install design of the D-Series Wall Size 1 make it the smart choice for building-mounted doorway and pathway illumination for nearly any facility.

### CONSTRUCTION

Two-piece die-cast aluminum housing has integral heat sink fins to optimize thermal management through conductive and convective cooling. Modular design allows for ease of maintenance. The LED driver is mounted to the door to thermally isolate it from the light engines for low operating temperature and long life. Housing is completely sealed against moisture and environmental contaminants (IP65).

### FINISH

Exterior parts are protected by a zinc-infused Super Durable TGIC thermoset powder coat finish that provides superior resistance to corrosion and weathering. A tightly controlled multi-stage process ensures a minimum 3 mils thickness for a finish that can withstand extreme climate changes without cracking or peeling. Available in textured and non-textured finishes.

### OPTICS

Precision-molded proprietary acrylic lenses provide multiple photometric distributions tailored specifically to building mounted applications. Light engines are available in 3000 K (70 min. CRI), 4000 K (70 min. CRI) or 5000 K (70 min. CRI) configurations.

### ELECTRICAL

Light engine(s) consist of 10 high-efficacy LEDs mounted to a metal-core circuit board to maximize heat dissipation and promote long life (L88/100,000 hrs at 25°C). Class 1 electronic drivers have a power factor >90%, THD <20%, and a minimum 2.5KV surge rating. When ordering the SPD option, a separate surge protection device is installed within the luminaire which meets a minimum Category C Low (per ANSI/IEEE C62.41.2).

### INSTALLATION

Included universal mounting bracket attaches securely to any 4" round or square outlet box for quick and easy installation. Luminaire has a slotted gasket wireway and attaches to the mounting bracket via corrosion-resistant screws.

### LISTINGS

CSA certified to U.S. and Canadian standards. Rated for -40°C minimum ambient.

DesignLights Consortium® (DLC) qualified product. Not all versions of this product may be DLC qualified. Please check the DLC Qualified Products List at [www.designlights.org/QPL](http://www.designlights.org/QPL) to confirm which versions are qualified.

### WARRANTY

Five-year limited warranty. Complete warranty terms located at: [www.acuitybrands.com/resources/terms-and-conditions](http://www.acuitybrands.com/resources/terms-and-conditions)

**Note:** Actual performance may differ as a result of end-user environment and application. All values are design or typical values, measured under laboratory conditions at 25 °C. Specifications subject to change without notice.





# D-Series Size 1 LED Wall Luminaire



Catalog Number

Notes

Type

Hit the Tab key or mouse over the page to see all interactive elements.

d#series

## Specifications Luminaire

<b>Width:</b>	13-3/4" (34.9 cm)	<b>Weight:</b>	12 lbs (5.4 kg)
<b>Depth:</b>	10" (25.4 cm)		
<b>Height:</b>	6-3/8" (16.2 cm)		

## Back Box (BBW, ELCW)

<b>Width:</b>	13-3/4" (34.9 cm)	<b>BBW Weight:</b>	5 lbs (2.3 kg)
<b>Depth:</b>	4" (10.2 cm)	<b>ELCW Weight:</b>	10 lbs (4.5 kg)
<b>Height:</b>	6-3/8" (16.2 cm)		

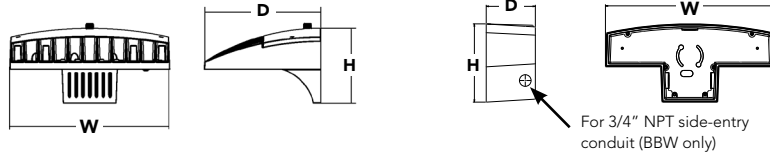

## Introduction

The D-Series Wall luminaire is a stylish, fully integrated LED solution for building-mount applications. It features a sleek, modern design and is carefully engineered to provide long-lasting, energy-efficient lighting with a variety of optical and control options for customized performance.

With an expected service life of over 20 years of nighttime use and up to 74% in energy savings over comparable 250W metal halide luminaires, the D-Series Wall is a reliable, low-maintenance lighting solution that produces sites that are exceptionally illuminated.

## Ordering Information

EXAMPLE: DSXW1 LED 20C 1000 40K T3M MVOLT DBBTD

Series	LEDs	Drive Current	Color temperature	Distribution	Voltage	Mounting	Control Options
<b>DSXW1 LED</b>							
<b>DSXW1 LED</b>	10C 10 LEDs (one engine) 20C 20 LEDs (two engines) <sup>1</sup>	350 350 mA 530 530 mA 700 700 mA 1000 1000 mA (1 A) <sup>1</sup>	30K 3000 K 40K 4000 K 50K 5000 K AMBPC Amber phosphor converted	T2S Type II Short T2M Type II Medium T3S Type III Short T3M Type III Medium T4M Type IV Medium TFTM Forward Throw Medium	MVOLT <sup>2</sup> 120 <sup>3</sup> 208 <sup>3</sup> 240 <sup>3</sup> 277 <sup>3</sup> 347 <sup>3,4</sup> 480 <sup>3,4</sup>	Shipped included (blank) Surface mounting bracket BBW Surface-mounted back box (for conduit entry) <sup>5</sup>	Shipped installed PE Photoelectric cell, button type <sup>6</sup> DMG 0-10v dimming wires pulled outside fixture (for use with an external control, ordered separately) PIR 180° motion/ambient light sensor, <15' mtg ht <sup>1,7</sup> PIRH 180° motion/ambient light sensor, 15-30' mtg ht <sup>1,7</sup> PIR1FC3V Motion/ambient sensor, 8-15' mounting height, ambient sensor enabled at 1fc <sup>1,7</sup> PIRH1FC3V Motion/ambient sensor, 15-30' mounting height, ambient sensor enabled at 1fc <sup>1,7</sup> ELCW Emergency battery backup (includes external component enclosure), CA Title 20 Noncompliant <sup>8,9</sup>

Other Options	Finish (required)
<b>Shipped installed</b> SF Single fuse (120, 277 or 347V) <sup>3,10</sup> DF Double fuse (208, 240 or 480V) <sup>3,10</sup> HS House-side shield <sup>11</sup> SPD Separate surge protection <sup>12</sup>	DDBXD Dark bronze DBLXD Black DNAXD Natural aluminum DWHXD White DSSXD Sandstone DBBTD Textured dark bronze DBLBXD Textured black DNATXD Textured natural aluminum DWHGXD Textured white DSSTXD Textured sandstone

## Accessories

Ordered and shipped separately.

DSXWHS U	House-side shield (one per light engine)
DSXWBSW U	Bird-deterrent spikes
DSXW1WG U	Wire guard accessory
DSXW1VG U	Vandal guard accessory

## NOTES

- 20C 1000 is not available with PIR, PIRH, PIR1FC3V or PIRH1FC3V.
- MVOLT driver operates on any line voltage from 120-277V (50/60 Hz).
- Single fuse (SF) requires 120, 277 or 347 voltage option. Double fuse (DF) requires 208, 240 or 480 voltage option.
- Only available with 20C, 700mA or 1000mA. Not available with PIR or PIRH.
- Back box ships installed on fixture. Cannot be field installed. Cannot be ordered as an accessory.
- Photocontrol (PE) requires 120, 208, 240, 277 or 347 voltage option. Not available with motion/ambient light sensors (PIR or PIRH).
- Reference Motion Sensor table on page 3.
- Cold weather (-20C) rated. Not compatible with conduit entry applications. Not available with BBW mounting option. Not available with fusing. Not available with 347 or 480 voltage options. Emergency components located in back box housing. Emergency mode IES files located on product page at [www.lithonia.com](http://www.lithonia.com)
- Not available with SPD.
- Not available with ELCW.
- Also available as a separate accessory; see Accessories information.
- Not available with ELCW.



# Performance Data

## Lumen Output

Lumen values are from photometric tests performed in accordance with IESNA LM-79-08. Data is considered to be representative of the configurations shown, within the tolerances allowed by Lighting Facts. Contact factory for performance data on any configurations not shown here.

LEDs	Drive Current (mA)	System Watts	Dist. Type	30K (3000 K, 70CRI)					40K (4000 K, 70CRI)					50K (5000 K, 70CRI)					AMBPC (Amber Phosphor Converted)				
				Lumens	B	U	G	LPW	Lumens	B	U	G	LPW	Lumens	B	U	G	LPW	Lumens	B	U	G	LPW
(10 LEDs)	350mA	13W	T2S	1,415	0	0	1	109	1,520	0	0	1	117	1,530	0	0	1	118	894	0	0	1	69
			T2M	1,349	0	0	1	104	1,448	0	0	1	111	1,458	0	0	1	112	852	0	0	1	66
			T3S	1,399	0	0	1	108	1,503	0	0	1	116	1,512	0	0	1	116	884	0	0	1	68
			T3M	1,385	0	0	1	107	1,488	0	0	1	114	1,497	0	0	1	115	876	0	0	1	67
			T4M	1,357	0	0	1	104	1,458	0	0	1	112	1,467	0	0	1	113	858	0	0	1	66
			TFTM	1,411	0	0	1	109	1,515	0	0	1	117	1,525	0	0	1	117	892	0	0	1	69
	530 mA	19W	ASYDF	1,262	1	0	1	97	1,354	1	0	1	104	1,363	1	0	1	105	797	0	0	1	61
			T2S	2,053	1	0	1	108	2,205	1	0	1	116	2,220	1	0	1	117	1,264	0	0	1	67
			T2M	1,957	1	0	1	103	2,102	1	0	1	111	2,115	1	0	1	111	1,205	0	0	1	63
			T3S	2,031	1	0	1	107	2,181	1	0	1	115	2,194	1	0	1	115	1,250	0	0	1	66
			T3M	2,010	1	0	1	106	2,159	1	0	1	114	2,172	1	0	1	114	1,237	0	0	1	65
			T4M	1,970	1	0	1	104	2,115	1	0	1	111	2,129	1	0	1	112	1,212	0	0	1	64
	700 mA	26W	TFTM	2,047	0	0	1	108	2,198	1	0	1	116	2,212	1	0	1	116	1,260	0	0	1	66
			ASYDF	1,831	1	0	1	96	1,966	1	0	1	103	1,978	1	0	1	104	1,127	0	0	1	59
			T2S	2,623	1	0	1	101	2,816	1	0	1	108	2,834	1	0	1	109	1,544	0	0	1	59
			T2M	2,499	1	0	1	96	2,684	1	0	1	103	2,701	1	0	1	104	1,472	0	0	1	57
			T3S	2,593	1	0	1	100	2,785	1	0	1	107	2,802	1	0	1	108	1,527	0	0	1	59
			T3M	2,567	1	0	1	99	2,757	1	0	1	106	2,774	1	0	1	107	1,512	0	0	1	58
	1000 mA	39W	T4M	2,515	1	0	1	97	2,701	1	0	1	104	2,718	1	0	1	105	1,481	0	0	1	57
			TFTM	2,614	1	0	1	101	2,808	1	0	1	108	2,825	1	0	1	109	1,539	0	0	1	59
			ASYDF	2,337	1	0	1	90	2,510	1	0	1	97	2,525	1	0	1	97	1,376	1	0	1	53
			T2S	3,685	1	0	1	94	3,957	1	0	1	101	3,982	1	0	1	102	2,235	1	0	1	57
			T2M	3,512	1	0	1	90	3,771	1	0	1	97	3,794	1	0	1	97	2,130	1	0	1	55
			T3S	3,644	1	0	1	93	3,913	1	0	1	100	3,938	1	0	1	101	2,210	1	0	1	57
(20 LEDs)	350mA	23W	T3M	3,607	1	0	1	92	3,873	1	0	1	99	3,898	1	0	1	100	2,187	1	0	1	56
			T4M	3,534	1	0	2	91	3,796	1	0	2	97	3,819	1	0	2	98	2,143	1	0	1	55
			TFTM	3,673	1	0	1	94	3,945	1	0	1	101	3,969	1	0	1	102	2,228	1	0	1	57
			ASYDF	3,284	1	0	2	84	3,527	1	0	2	90	3,549	1	0	2	91	1,992	1	0	1	51
			T2S	2,820	1	0	1	123	3,028	1	0	1	132	3,047	1	0	1	132	1,777	1	0	1	77
			T2M	2,688	1	0	1	117	2,886	1	0	1	125	2,904	1	0	1	126	1,693	1	0	1	74
	530 mA	35W	T3S	2,789	1	0	1	121	2,994	1	0	1	130	3,014	1	0	1	131	1,757	0	0	1	76
			T3M	2,760	1	0	1	120	2,965	1	0	1	129	2,983	1	0	1	130	1,739	1	0	1	76
			T4M	2,704	1	0	1	118	2,905	1	0	1	126	2,922	1	0	1	127	1,704	1	0	1	74
			TFTM	2,811	1	0	1	122	3,019	1	0	1	131	3,038	1	0	1	132	1,771	0	0	1	77
			ASYDF	2,514	1	0	1	109	2,699	1	0	1	117	2,716	1	0	1	118	1,584	1	0	1	69
			T2S	4,079	1	0	1	117	4,380	1	0	1	125	4,407	1	0	1	126	2,504	1	0	1	72
	700 mA	46W	T2M	3,887	1	0	1	111	4,174	1	0	1	119	4,201	1	0	1	120	2,387	1	0	1	68
			T3S	4,033	1	0	1	115	4,331	1	0	1	124	4,359	1	0	1	125	2,477	1	0	1	71
			T3M	3,993	1	0	2	114	4,288	1	0	2	123	4,315	1	0	2	123	2,451	1	0	1	70
			T4M	3,912	1	0	2	112	4,201	1	0	2	120	4,227	1	0	2	121	2,402	1	0	1	69
			TFTM	4,066	1	0	2	116	4,366	1	0	2	125	4,394	1	0	2	126	2,496	1	0	1	71
			ASYDF	3,636	1	0	2	104	3,904	1	0	2	112	3,928	1	0	2	112	2,232	1	0	1	64
	1000 mA	73W	T2S	5,188	1	0	1	113	5,572	1	0	1	121	5,607	1	0	1	122	3,065	1	0	1	67
			T2M	4,945	1	0	2	108	5,309	1	0	2	115	5,343	1	0	2	116	2,921	1	0	1	64
			T3S	5,131	1	0	2	112	5,510	1	0	2	120	5,544	1	0	2	121	3,031	1	0	1	66
			T3M	5,078	1	0	2	110	5,454	1	0	2	119	5,487	1	0	2	119	3,000	1	0	1	65
			T4M	4,975	1	0	2	108	5,343	1	0	2	116	5,376	1	0	2	117	2,939	1	0	1	64
			TFTM	5,172	1	0	2	112	5,554	1	0	2	121	5,589	1	0	2	122	3,055	1	0	1	66
1000 mA	73W	ASYDF	4,624	1	0	2	101	4,965	1	0	2	108	4,996	1	0	2	109	2,732	1	0	1	59	
		T2S	7,204	1	0	2	99	7,736	2	0	2	106	7,784	2	0	2	107	4,429	1	0	1	61	
		T2M	6,865	1	0	2	94	7,373	2	0	2	101	7,419	2	0	2	102	4,221	1	0	1	58	
		T3S	7,125	1	0	2	98	7,651	1	0	2	105	7,698	1	0	2	105	4,380	1	0	1	60	
		T3M	7,052	1	0	2	97	7,573	2	0	2	104	7,620	2	0	2	104	4,335	1	0	2	59	
		T4M	6,909	1	0	2	95	7,420	1	0	2	102	7,466	1	0	2	102	4,248	1	0	2	58	
1000 mA	73W	TFTM	7,182	1	0	2	98	7,712	1	0	2	106	7,761	1	0	2	106	4,415	1	0	2	60	
		ASYDF	6,421	2	0	2	88	6,896	2	0	3	94	6,938	2	0	3	95	3,947	1	0	2	54	



## Performance Data

### Lumen Ambient Temperature (LAT) Multipliers

Use these factors to determine relative lumen output for average ambient temperatures from 0-40°C (32-104°F).

Ambient		Lumen Multiplier
0°C	32°F	1.02
10°C	50°F	1.01
20°C	68°F	1.00
25°C	77°F	1.00
30°C	86°F	1.00
40°C	104°F	0.98

### Projected LED Lumen Maintenance

Data references the extrapolated performance projections for the DSXW1 LED 20C 1000 platform in a 25°C ambient, based on 10,000 hours of LED testing (tested per IESNA LM-80-08 and projected per IESNA TM-21-11).

To calculate LLF, use the lumen maintenance factor that corresponds to the desired number of operating hours below. For other lumen maintenance values, contact factory.

Operating Hours	0	25,000	50,000	100,000
Lumen Maintenance Factor	1.0	0.95	0.93	0.88

### Electrical Load

LEDs	Drive Current (mA)	System Watts	Current (A)					
			120V	208V	240V	277V	347V	480V
10C	350	14 W	0.13	0.07	0.06	0.06	-	-
	530	20 W	0.19	0.11	0.09	0.08	-	-
	700	27 W	0.25	0.14	0.13	0.11	-	-
	1000	40 W	0.37	0.21	0.19	0.16	-	-
20C	350	24 W	0.23	0.13	0.12	0.10	-	-
	530	36 W	0.33	0.19	0.17	0.14	-	-
	700	47 W	0.44	0.25	0.22	0.19	0.15	0.11
	1000	74 W	0.69	0.40	0.35	0.30	0.23	0.17

### Motion Sensor Default Settings

Option	Dimmed State	High Level (when triggered)	Photocell Operation	Dwell Time	Ramp-up Time	Ramp-down Time
*PIR or PIRH	3V (37%) Output	10V (100%) Output	Enabled @ 5FC	5 min	3 sec	5 min
PIR1FC3V or PIRH1FC3V	3V (37%) Output	10V (100%) Output	Enabled @ 1FC	5 min	3 sec	5 min

\*for use with Inline Dusk to Dawn or timer

## Photometric Diagrams

To see complete photometric reports or download .ies files for this product, visit Lithonia Lighting's [D-Series Wall Size 1 homepage](#).

Isofootcandle plots for the DSXW1 LED 20C 1000 40K. Distances are in units of mounting height (15').

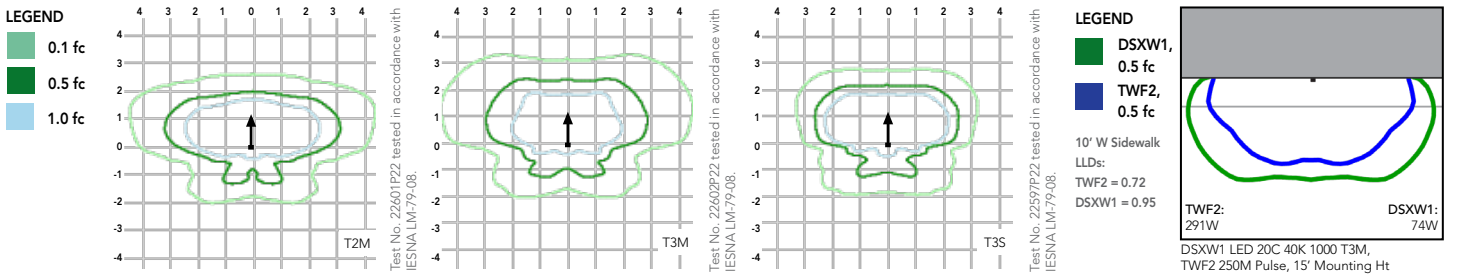

## Options and Accessories



T3M (left), ASYDF (right) lenses



HS - House-side shields



BSW - Bird-deterrent spikes



WG - Wire guard



VG - Vandal guard



DDL - Diffused drop lens

## FEATURES & SPECIFICATIONS

### INTENDED USE

The energy savings, long life and easy-to-install design of the D-Series Wall Size 1 make it the smart choice for building-mounted doorway and pathway illumination for nearly any facility.

### CONSTRUCTION

Two-piece die-cast aluminum housing has integral heat sink fins to optimize thermal management through conductive and convective cooling. Modular design allows for ease of maintenance. The LED driver is mounted to the door to thermally isolate it from the light engines for low operating temperature and long life. Housing is completely sealed against moisture and environmental contaminants (IP65).

### FINISH

Exterior parts are protected by a zinc-infused Super Durable TGIC thermoset powder coat finish that provides superior resistance to corrosion and weathering. A tightly controlled multi-stage process ensures a minimum 3 mils thickness for a finish that can withstand extreme climate changes without cracking or peeling. Available in textured and non-textured finishes.

### OPTICS

Precision-molded proprietary acrylic lenses provide multiple photometric distributions tailored specifically to building mounted applications. Light engines are available in 3000 K (70 min. CRI), 4000 K (70 min. CRI) or 5000 K (70 min. CRI) configurations.

### ELECTRICAL

Light engine(s) consist of 10 high-efficacy LEDs mounted to a metal-core circuit board to maximize heat dissipation and promote long life (L88/100,000 hrs at 25°C). Class 1 electronic drivers have a power factor >90%, THD <20%, and a minimum 2.5KV surge rating. When ordering the SPD option, a separate surge protection device is installed within the luminaire which meets a minimum Category C Low (per ANSI/IEEE C62.41.2).

### INSTALLATION

Included universal mounting bracket attaches securely to any 4" round or square outlet box for quick and easy installation. Luminaire has a slotted gasket wireway and attaches to the mounting bracket via corrosion-resistant screws.

### LISTINGS

CSA certified to U.S. and Canadian standards. Rated for -40°C minimum ambient.

DesignLights Consortium® (DLC) qualified product. Not all versions of this product may be DLC qualified. Please check the DLC Qualified Products List at [www.designlights.org/QPL](http://www.designlights.org/QPL) to confirm which versions are qualified.

### WARRANTY

Five-year limited warranty. Complete warranty terms located at: [www.acuitybrands.com/resources/terms-and-conditions](http://www.acuitybrands.com/resources/terms-and-conditions)

**Note:** Actual performance may differ as a result of end-user environment and application. All values are design or typical values, measured under laboratory conditions at 25 °C. Specifications subject to change without notice.





# D-Series Size 1 LED Wall Luminaire



Catalog Number

Notes

Type

Hit the Tab key or mouse over the page to see all interactive elements.

d#series

## Specifications Luminaire

<b>Width:</b>	13-3/4" (34.9 cm)	<b>Weight:</b>	12 lbs (5.4 kg)
<b>Depth:</b>	10" (25.4 cm)		
<b>Height:</b>	6-3/8" (16.2 cm)		

## Back Box (BBW, ELCW)

<b>Width:</b>	13-3/4" (34.9 cm)	<b>BBW Weight:</b>	5 lbs (2.3 kg)
<b>Depth:</b>	4" (10.2 cm)	<b>ELCW Weight:</b>	10 lbs (4.5 kg)
<b>Height:</b>	6-3/8" (16.2 cm)		

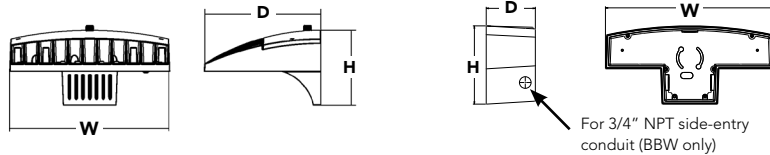

## Introduction

The D-Series Wall luminaire is a stylish, fully integrated LED solution for building-mount applications. It features a sleek, modern design and is carefully engineered to provide long-lasting, energy-efficient lighting with a variety of optical and control options for customized performance.

With an expected service life of over 20 years of nighttime use and up to 74% in energy savings over comparable 250W metal halide luminaires, the D-Series Wall is a reliable, low-maintenance lighting solution that produces sites that are exceptionally illuminated.

## Ordering Information

EXAMPLE: DSXW1 LED 20C 1000 40K T3M MVOLT DBBTD

Series	LEDs	Drive Current	Color temperature	Distribution	Voltage	Mounting	Control Options
<b>DSXW1 LED</b>							
<b>DSXW1 LED</b>	<b>10C</b> 10 LEDs (one engine) <b>20C</b> 20 LEDs (two engines) <sup>1</sup>	350 350 mA 530 530 mA <b>700</b> 700 mA 1000 1000 mA (1 A) <sup>1</sup>	30K 3000 K 40K 4000 K <b>50K</b> 5000 K AMBPC Amber phosphor converted	T2S Type II Short T2M Type II Medium T3S Type III Short T3M Type III Medium <b>T4M</b> Type IV Medium TFTM Forward Throw Medium	<b>MVOLT</b> <sup>2</sup> 120 <sup>3</sup> 208 <sup>3</sup> 240 <sup>3</sup> 277 <sup>3</sup> 347 <sup>3,4</sup> 480 <sup>3,4</sup>	<b>Shipped included</b> (blank) Surface mounting bracket <b>BBW</b> Surface-mounted back box (for conduit entry) <sup>5</sup>	<b>Shipped installed</b> PE Photoelectric cell, button type <sup>6</sup> DMG 0-10v dimming wires pulled outside fixture (for use with an external control, ordered separately) PIR 180° motion/ambient light sensor, <15' mtg ht <sup>1,7</sup> PIRH 180° motion/ambient light sensor, 15-30' mtg ht <sup>1,7</sup> PIR1FC3V Motion/ambient sensor, 8-15' mounting height, ambient sensor enabled at 1fc <sup>1,7</sup> PIRH1FC3V Motion/ambient sensor, 15-30' mounting height, ambient sensor enabled at 1fc <sup>1,7</sup> ELCW Emergency battery backup (includes external component enclosure), CA Title 20 Noncompliant <sup>8,9</sup>

### Other Options

### Finish (required)

#### Shipped installed

SF	Single fuse (120, 277 or 347V) <sup>3,10</sup>
DF	Double fuse (208, 240 or 480V) <sup>3,10</sup>
HS	House-side shield <sup>11</sup>
SPD	Separate surge protection <sup>12</sup>

#### Shipped separately<sup>11</sup>

BSW	Bird-deterrent spikes
WG	Wire guard
VG	Vandal guard
DDL	Diffused drop lens

DDBXD	Dark bronze	DSSXD	Sandstone
DBLXD	Black	DBBTD	Textured dark bronze
DNAXD	Natural aluminum	DBLBXD	Textured black
DWHXD	White	DNATXD	Textured natural aluminum

DWHGXD	Textured white
DSSTXD	Textured sandstone

## Accessories

Ordered and shipped separately.

DSXWHS U	House-side shield (one per light engine)
DSXWBSW U	Bird-deterrent spikes
DSXW1WG U	Wire guard accessory
DSXW1VG U	Vandal guard accessory

### NOTES

- 20C 1000 is not available with PIR, PIRH, PIR1FC3V or PIRH1FC3V.
- MVOLT driver operates on any line voltage from 120-277V (50/60 Hz).
- Single fuse (SF) requires 120, 277 or 347 voltage option. Double fuse (DF) requires 208, 240 or 480 voltage option.
- Only available with 20C, 700mA or 1000mA. Not available with PIR or PIRH.
- Back box ships installed on fixture. Cannot be field installed. Cannot be ordered as an accessory.
- Photocontrol (PE) requires 120, 208, 240, 277 or 347 voltage option. Not available with motion/ambient light sensors (PIR or PIRH).
- Reference Motion Sensor table on page 3.
- Cold weather (-20C) rated. Not compatible with conduit entry applications. Not available with BBW mounting option. Not available with fusing. Not available with 347 or 480 voltage options. Emergency components located in back box housing. Emergency mode IES files located on product page at [www.lithonia.com](http://www.lithonia.com)
- Not available with SPD.
- Not available with ELCW.
- Also available as a separate accessory; see Accessories information.
- Not available with ELCW.





# Performance Data

## Lumen Output

Lumen values are from photometric tests performed in accordance with IESNA LM-79-08. Data is considered to be representative of the configurations shown, within the tolerances allowed by Lighting Facts. Contact factory for performance data on any configurations not shown here.

LEDs	Drive Current (mA)	System Watts	Dist. Type	30K (3000 K, 70CRI)					40K (4000 K, 70CRI)					50K (5000 K, 70CRI)					AMBPC (Amber Phosphor Converted)				
				Lumens	B	U	G	LPW	Lumens	B	U	G	LPW	Lumens	B	U	G	LPW	Lumens	B	U	G	LPW
(10 LEDs)	350mA	13W	T2S	1,415	0	0	1	109	1,520	0	0	1	117	1,530	0	0	1	118	894	0	0	1	69
			T2M	1,349	0	0	1	104	1,448	0	0	1	111	1,458	0	0	1	112	852	0	0	1	66
			T3S	1,399	0	0	1	108	1,503	0	0	1	116	1,512	0	0	1	116	884	0	0	1	68
			T3M	1,385	0	0	1	107	1,488	0	0	1	114	1,497	0	0	1	115	876	0	0	1	67
			T4M	1,357	0	0	1	104	1,458	0	0	1	112	1,467	0	0	1	113	858	0	0	1	66
			TFTM	1,411	0	0	1	109	1,515	0	0	1	117	1,525	0	0	1	117	892	0	0	1	69
	ASDYF	1,262	1	0	1	97	1,354	1	0	1	104	1,363	1	0	1	105	797	0	0	1	61		
	530 mA	19W	T2S	2,053	1	0	1	108	2,205	1	0	1	116	2,220	1	0	1	117	1,264	0	0	1	67
			T2M	1,957	1	0	1	103	2,102	1	0	1	111	2,115	1	0	1	111	1,205	0	0	1	63
			T3S	2,031	1	0	1	107	2,181	1	0	1	115	2,194	1	0	1	115	1,250	0	0	1	66
			T3M	2,010	1	0	1	106	2,159	1	0	1	114	2,172	1	0	1	114	1,237	0	0	1	65
			T4M	1,970	1	0	1	104	2,115	1	0	1	111	2,129	1	0	1	112	1,212	0	0	1	64
			TFTM	2,047	0	0	1	108	2,198	1	0	1	116	2,212	1	0	1	116	1,260	0	0	1	66
	ASDYF	1,831	1	0	1	96	1,966	1	0	1	103	1,978	1	0	1	104	1,127	0	0	1	59		
	700 mA	26W	T2S	2,623	1	0	1	101	2,816	1	0	1	108	2,834	1	0	1	109	1,544	0	0	1	59
			T2M	2,499	1	0	1	96	2,684	1	0	1	103	2,701	1	0	1	104	1,472	0	0	1	57
			T3S	2,593	1	0	1	100	2,785	1	0	1	107	2,802	1	0	1	108	1,527	0	0	1	59
			T3M	2,567	1	0	1	99	2,757	1	0	1	106	2,774	1	0	1	107	1,512	0	0	1	58
			T4M	2,515	1	0	1	97	2,701	1	0	1	104	2,718	1	0	1	105	1,481	0	0	1	57
			TFTM	2,614	1	0	1	101	2,808	1	0	1	108	2,825	1	0	1	109	1,539	0	0	1	59
	ASDYF	2,337	1	0	1	90	2,510	1	0	1	97	2,525	1	0	1	97	1,376	1	0	1	53		
	1000 mA	39W	T2S	3,685	1	0	1	94	3,957	1	0	1	101	3,982	1	0	1	102	2,235	1	0	1	57
			T2M	3,512	1	0	1	90	3,771	1	0	1	97	3,794	1	0	1	97	2,130	1	0	1	55
			T3S	3,644	1	0	1	93	3,913	1	0	1	100	3,938	1	0	1	101	2,210	1	0	1	57
T3M			3,607	1	0	1	92	3,873	1	0	1	99	3,898	1	0	1	100	2,187	1	0	1	56	
T4M			3,534	1	0	2	91	3,796	1	0	2	97	3,819	1	0	2	98	2,143	1	0	1	55	
TFTM			3,673	1	0	1	94	3,945	1	0	1	101	3,969	1	0	1	102	2,228	1	0	1	57	
ASDYF	3,284	1	0	2	84	3,527	1	0	2	90	3,549	1	0	2	91	1,992	1	0	1	51			
(20 LEDs)	350mA	23W	T2S	2,820	1	0	1	123	3,028	1	0	1	132	3,047	1	0	1	132	1,777	1	0	1	77
			T2M	2,688	1	0	1	117	2,886	1	0	1	125	2,904	1	0	1	126	1,693	1	0	1	74
			T3S	2,789	1	0	1	121	2,994	1	0	1	130	3,014	1	0	1	131	1,757	0	0	1	76
			T3M	2,760	1	0	1	120	2,965	1	0	1	129	2,983	1	0	1	130	1,739	1	0	1	76
			T4M	2,704	1	0	1	118	2,905	1	0	1	126	2,922	1	0	1	127	1,704	1	0	1	74
			TFTM	2,811	1	0	1	122	3,019	1	0	1	131	3,038	1	0	1	132	1,771	0	0	1	77
	ASDYF	2,514	1	0	1	109	2,699	1	0	1	117	2,716	1	0	1	118	1,584	1	0	1	69		
	530 mA	35W	T2S	4,079	1	0	1	117	4,380	1	0	1	125	4,407	1	0	1	126	2,504	1	0	1	72
			T2M	3,887	1	0	1	111	4,174	1	0	1	119	4,201	1	0	1	120	2,387	1	0	1	68
			T3S	4,033	1	0	1	115	4,331	1	0	1	124	4,359	1	0	1	125	2,477	1	0	1	71
			T3M	3,993	1	0	2	114	4,288	1	0	2	123	4,315	1	0	2	123	2,451	1	0	1	70
			T4M	3,912	1	0	2	112	4,201	1	0	2	120	4,227	1	0	2	121	2,402	1	0	1	69
			TFTM	4,066	1	0	2	116	4,366	1	0	2	125	4,394	1	0	2	126	2,496	1	0	1	71
	ASDYF	3,636	1	0	2	104	3,904	1	0	2	112	3,928	1	0	2	112	2,232	1	0	1	64		
	700 mA	46W	T2S	5,188	1	0	1	113	5,572	1	0	1	121	5,607	1	0	1	122	3,065	1	0	1	67
			T2M	4,945	1	0	2	108	5,309	1	0	2	115	5,343	1	0	2	116	2,921	1	0	1	64
			T3S	5,131	1	0	2	112	5,510	1	0	2	120	5,544	1	0	2	121	3,031	1	0	1	66
			T3M	5,078	1	0	2	110	5,454	1	0	2	119	5,487	1	0	2	119	3,000	1	0	1	65
			T4M	4,975	1	0	2	108	5,343	1	0	2	116	5,376	1	0	2	117	2,939	1	0	1	64
			TFTM	5,172	1	0	2	112	5,554	1	0	2	121	5,589	1	0	2	122	3,055	1	0	1	66
	ASDYF	4,624	1	0	2	101	4,965	1	0	2	108	4,996	1	0	2	109	2,732	1	0	1	59		
	1000 mA	73W	T2S	7,204	1	0	2	99	7,736	2	0	2	106	7,784	2	0	2	107	4,429	1	0	1	61
			T2M	6,865	1	0	2	94	7,373	2	0	2	101	7,419	2	0	2	102	4,221	1	0	1	58
			T3S	7,125	1	0	2	98	7,651	1	0	2	105	7,698	1	0	2	105	4,380	1	0	1	60
T3M			7,052	1	0	2	97	7,573	2	0	2	104	7,620	2	0	2	104	4,335	1	0	2	59	
T4M			6,909	1	0	2	95	7,420	1	0	2	102	7,466	1	0	2	102	4,248	1	0	2	58	
TFTM			7,182	1	0	2	98	7,712	1	0	2	106	7,761	1	0	2	106	4,415	1	0	2	60	
ASDYF	6,421	2	0	2	88	6,896	2	0	3	94	6,938	2	0	3	95	3,947	1	0	2	54			



COMMERCIAL OUTDOOR

One Lithonia Way • Conyers, Georgia 30012 • Phone: 800.775.4378 • [www.lithonia.com](http://www.lithonia.com)  
 © 2013-2019 Acuity Brands Lighting, Inc. All rights reserved.

DSXW1-LED  
 Rev. 8/15/19

## Performance Data

### Lumen Ambient Temperature (LAT) Multipliers

Use these factors to determine relative lumen output for average ambient temperatures from 0-40°C (32-104°F).

Ambient		Lumen Multiplier
0°C	32°F	1.02
10°C	50°F	1.01
20°C	68°F	1.00
25°C	77°F	1.00
30°C	86°F	1.00
40°C	104°F	0.98

### Projected LED Lumen Maintenance

Data references the extrapolated performance projections for the DSXW1 LED 20C 1000 platform in a 25°C ambient, based on 10,000 hours of LED testing (tested per IESNA LM-80-08 and projected per IESNA TM-21-11).

To calculate LLF, use the lumen maintenance factor that corresponds to the desired number of operating hours below. For other lumen maintenance values, contact factory.

Operating Hours	0	25,000	50,000	100,000
Lumen Maintenance Factor	1.0	0.95	0.93	0.88

### Electrical Load

LEDs	Drive Current (mA)	System Watts	Current (A)					
			120V	208V	240V	277V	347V	480V
10C	350	14 W	0.13	0.07	0.06	0.06	-	-
	530	20 W	0.19	0.11	0.09	0.08	-	-
	700	27 W	0.25	0.14	0.13	0.11	-	-
	1000	40 W	0.37	0.21	0.19	0.16	-	-
20C	350	24 W	0.23	0.13	0.12	0.10	-	-
	530	36 W	0.33	0.19	0.17	0.14	-	-
	700	47 W	0.44	0.25	0.22	0.19	0.15	0.11
	1000	74 W	0.69	0.40	0.35	0.30	0.23	0.17

### Motion Sensor Default Settings

Option	Dimmed State	High Level (when triggered)	Photocell Operation	Dwell Time	Ramp-up Time	Ramp-down Time
*PIR or PIRH	3V (37%) Output	10V (100%) Output	Enabled @ 5FC	5 min	3 sec	5 min
PIR1FC3V or PIRH1FC3V	3V (37%) Output	10V (100%) Output	Enabled @ 1FC	5 min	3 sec	5 min

\*for use with Inline Dusk to Dawn or timer

## Photometric Diagrams

To see complete photometric reports or download .ies files for this product, visit Lithonia Lighting's [D-Series Wall Size 1 homepage](#).

Isfootcandle plots for the DSXW1 LED 20C 1000 40K. Distances are in units of mounting height (15').

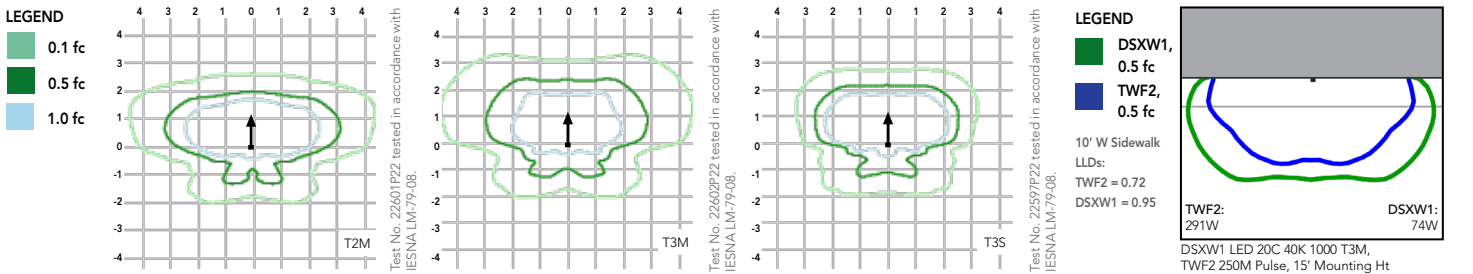

## Options and Accessories



T3M (left), ASYDF (right) lenses



HS - House-side shields



BSW - Bird-deterrent spikes



WG - Wire guard



VG - Vandal guard



DDL - Diffused drop lens

## FEATURES & SPECIFICATIONS

### INTENDED USE

The energy savings, long life and easy-to-install design of the D-Series Wall Size 1 make it the smart choice for building-mounted doorway and pathway illumination for nearly any facility.

### CONSTRUCTION

Two-piece die-cast aluminum housing has integral heat sink fins to optimize thermal management through conductive and convective cooling. Modular design allows for ease of maintenance. The LED driver is mounted to the door to thermally isolate it from the light engines for low operating temperature and long life. Housing is completely sealed against moisture and environmental contaminants (IP65).

### FINISH

Exterior parts are protected by a zinc-infused Super Durable TGIC thermoset powder coat finish that provides superior resistance to corrosion and weathering. A tightly controlled multi-stage process ensures a minimum 3 mils thickness for a finish that can withstand extreme climate changes without cracking or peeling. Available in textured and non-textured finishes.

### OPTICS

Precision-molded proprietary acrylic lenses provide multiple photometric distributions tailored specifically to building mounted applications. Light engines are available in 3000 K (70 min. CRI), 4000 K (70 min. CRI) or 5000 K (70 min. CRI) configurations.

### ELECTRICAL

Light engine(s) consist of 10 high-efficacy LEDs mounted to a metal-core circuit board to maximize heat dissipation and promote long life (L88/100,000 hrs at 25°C). Class 1 electronic drivers have a power factor >90%, THD <20%, and a minimum 2.5KV surge rating. When ordering the SPD option, a separate surge protection device is installed within the luminaire which meets a minimum Category C Low (per ANSI/IEEE C62.41.2).

### INSTALLATION

Included universal mounting bracket attaches securely to any 4" round or square outlet box for quick and easy installation. Luminaire has a slotted gasket wireway and attaches to the mounting bracket via corrosion-resistant screws.

### LISTINGS

CSA certified to U.S. and Canadian standards. Rated for -40°C minimum ambient.

DesignLights Consortium® (DLC) qualified product. Not all versions of this product may be DLC qualified. Please check the DLC Qualified Products List at [www.designlights.org/QPL](http://www.designlights.org/QPL) to confirm which versions are qualified.

### WARRANTY

Five-year limited warranty. Complete warranty terms located at: [www.acuitybrands.com/resources/terms-and-conditions](http://www.acuitybrands.com/resources/terms-and-conditions)

**Note:** Actual performance may differ as a result of end-user environment and application. All values are design or typical values, measured under laboratory conditions at 25 °C. Specifications subject to change without notice.



COMMERCIAL OUTDOOR

One Lithonia Way • Conyers, Georgia 30012 • Phone: 800.775.4378 • [www.lithonia.com](http://www.lithonia.com)  
© 2013-2019 Acuity Brands Lighting, Inc. All rights reserved.

DSXW1-LED  
Rev. 8/15/19

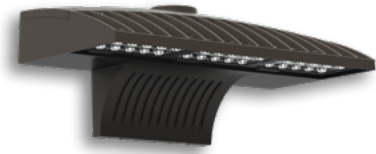

# D-Series Size 2 LED Wall Luminaire



d<sup>series</sup>

## Specifications Luminaire

**Width:** 18-1/2" (47.0 cm) **Weight:** 21 lbs (9.5 kg)  
**Depth:** 10" (25.4 cm)  
**Height:** 7-5/8" (19.4 cm)

## Back Box (BBW)

**Width:** 5-1/2" (14.0 cm) **BBW Weight:** 1 lbs (0.5 kg)  
**Depth:** 1-1/2" (3.8 cm)  
**Height:** 4" (10.2 cm)

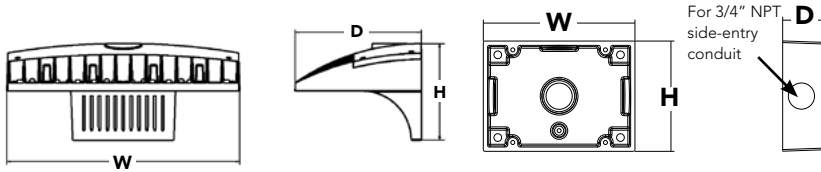

Catalog Number
Notes
Type

Hit the Tab key or mouse over the page to see all interactive elements.

## A+ Capable Luminaire

This item is an A+ capable luminaire, which has been designed and tested to provide consistent color appearance and system-level interoperability.

- All configurations of this luminaire meet the Acuity Brands' specification for chromatic consistency
- This luminaire is A+ Certified when ordered with DTL<sup>®</sup> controls marked by a shaded background. DTL DLL equipped luminaires meet the A+ specification for luminaire to photocontrol interoperability<sup>1</sup>
- This luminaire is part of an A+ Certified solution for ROAM<sup>®</sup> or XPoint<sup>™</sup> Wireless control networks, providing out-of-the-box control compatibility with simple commissioning, when ordered with drivers and control options marked by a shaded background<sup>1</sup>

To learn more about A+, visit [www.acuitybrands.com/aplus](http://www.acuitybrands.com/aplus).

- See ordering tree for details.
- A+ Certified Solutions for ROAM require the order of one ROAM node per luminaire. Sold Separately: [Link to Roam](#); [Link to DTL DLL](#)

A+ Capable options indicated by this color background.

## Ordering Information

EXAMPLE: DSXW2 LED 30C 700 40K T3M MVOLT DDBTXD

Series	LEDs	Drive Current	Color temperature	Distribution	Voltage	Mounting	Control Options
<b>DSXW2 LED</b>							
	20C 20 LEDs (two engines)	350 350 mA <b>530</b> 530 mA	30K 3000 K 40K 4000 K	T2S Type II Short T2M Type II Medium	<b>MVOLT</b> <sup>3</sup> 120 <sup>4</sup>	<b>Shipped included</b> (blank) Surface mounting bracket	<b>Shipped installed</b> PE Photoelectric cell, button type <sup>7</sup> <b>PER</b> NEMA twist-lock receptacle only (control ordered separate) <sup>8</sup>
	<b>30C</b> 30 LEDs (three engines)	700 700 mA 1000 1000 mA <sup>1</sup> (1 A)	<b>50K</b> 5000 K AMBPC Amber phosphor converted <sup>2</sup>	T3S Type III Short <b>T3M</b> Type III Medium T4M Type IV Medium TFTM Forward Throw Medium	208 <sup>4</sup> 240 <sup>4</sup> 277 <sup>4</sup> 347 <sup>4,5</sup> 480 <sup>4,5</sup>		
						<b>Shipped separately</b> <sup>6</sup> BBW Surface-mounted back box (for conduit entry)	DMG 0-10v dimming wires pulled outside fixture (for use with an external control, ordered separately) PIR 180° motion/ambient light sensor, <15' mtg ht <sup>10,11</sup> PIRH 180° motion/ambient light sensor, 15-30' mtg ht <sup>10,11</sup> PIR1FC3V Motion/ambient sensor, 8-15' mounting height, ambient sensor enabled at 1fc <sup>11,12</sup> PIRH1FC3V Motion/ambient sensor, 15-30' mounting height, ambient sensor enabled at 1fc <sup>11,12</sup>

### Other Options

### Finish (required)

<b>Shipped installed</b>	<b>Shipped separately</b> <sup>13</sup>	DDBXD Dark bronze	DSSXD Sandstone	DWHGXD Textured white
SF Single fuse (120, 277, 347V) <sup>3</sup>	BSW Bird-deterrent spikes	DBLXD Black	DDBTXD Textured dark bronze	DSSTXD Textured sandstone
DF Double fuse (208, 240, 480V) <sup>3</sup>	VG Vandal guard	DNAXD Natural aluminum	DBLBXD Textured black	
HS House-side shield <sup>4</sup>		DWHXD White	DNATXD Textured natural aluminum	
SPD Separate surge protection <sup>13</sup>				



## Ordering Information

### Accessories

Ordered and shipped separately.

DLL127F 1.5 JU	Photozell - SSL twist-lock (120-277V) <sup>14</sup>
DLL347F 1.5 CUL JU	Photozell - SSL twist-lock (347V) <sup>14</sup>
DLL480F 1.5 CUL JU	Photozell - SSL twist-lock (480V) <sup>14</sup>
DSHORT SBK U	Shorting cap (Included when ordering PER, PERS or PER7) <sup>14</sup>
DSXWHS U	House-side shield (one per light engine)
DSXWBSW U	Bird-deterrent spikes
DSXW2VG U	Vandal guard accessory
DSXW2BBW	Back box accessory
DBBXD U	(specify finish)

For more control options, visit [DTL](#) and [ROAM](#) online.

### NOTES

- 1000mA is not available with AMBPC.
- AMBPC is not available with 1000mA.
- MVOLT driver operates on any line voltage from 120-277V (50/60 Hz).
- Single fuse (SF) requires 120, 277 or 347 voltage option. Double fuse (DF) requires 208, 240 or 480 voltage option.
- Available with 30 LED/700mA options only (DSXW2 LED 30C 700). DMG option not available.
- Also available as a separate accessory; see Accessories information.
- Photocontrol (PE) requires 120, 208, 240, 277 or 347 voltage option. Not available with motion/ambient light sensors (PIR or PIRH).
- Photozell ordered and shipped as a separate line item from Acuity Brands Controls. See accessories. Shorting Cap included.
- If ROAM® node required, it must be ordered and shipped as a separate line item from Acuity Brands Controls. Shorting Cap included.
- Reference Motion Sensor table on page 3.
- Reference PER Table on page 3 for functionality.
- PIR and PIR1FC3V specify the [SensorSwitch SBGR-10-ODP](#) control; PIRH and PIRH1FC3V specify the [SensorSwitch SBGR-6-ODP](#) control; see [Motion Sensor Guide](#) for details. Dimming driver standard. Not available with PER5 or PER7. Separate on/off required.
- See the electrical section on page 2 for more details.
- Requires luminaire to be specified with PER option. Ordered and shipped as a separate line item. See PER Table.

## Performance Data

### Lumen Output

Lumen values are from photometric tests performed in accordance with IESNA LM-79-08. Data is considered to be representative of the configurations shown, within the tolerances allowed by Lighting Facts. Contact factory for performance data on any configurations not shown here.

LEDs	Drive Current (mA)	System Watts	Dist. Type	30K					40K					50K				
				Lumens	B	U	G	LPW	Lumens	B	U	G	LPW	Lumens	B	U	G	LPW
20C (20 LEDs)	350 mA	25W	T2S	2,783	1	0	1	111	2,989	1	0	1	120	3,008	1	0	1	120
			T2M	2,709	1	0	1	108	2,908	1	0	1	116	2,926	1	0	1	117
			T3S	2,748	1	0	1	110	2,951	1	0	1	118	2,969	1	0	1	119
			T3M	2,793	1	0	1	112	2,999	1	0	1	120	3,018	1	0	1	121
			T4M	2,756	1	0	1	110	2,959	1	0	1	118	2,977	1	0	1	119
			TFTM	2,753	1	0	1	110	2,956	1	0	1	118	2,975	1	0	1	119
	530 mA	36W	T2S	4,030	1	0	1	112	4,327	1	0	1	120	4,354	1	0	1	121
			T2M	3,920	1	0	1	109	4,210	1	0	1	117	4,236	1	0	1	118
			T3S	3,978	1	0	1	111	4,272	1	0	1	119	4,299	1	0	1	119
			T3M	4,044	1	0	2	112	4,343	1	0	2	121	4,370	1	0	2	121
			T4M	3,990	1	0	1	111	4,284	1	0	1	119	4,310	1	0	1	120
			TFTM	3,987	1	0	1	111	4,281	1	0	1	119	4,308	1	0	1	120
	700 mA	47W	T2S	5,130	1	0	1	109	5,509	1	0	1	117	5,544	1	0	1	118
			T2M	4,991	1	0	2	106	5,360	1	0	2	114	5,393	1	0	2	115
			T3S	5,066	1	0	1	108	5,440	1	0	1	116	5,474	1	0	1	116
			T3M	5,148	1	0	2	110	5,529	1	0	2	118	5,563	1	0	2	118
			T4M	5,080	1	0	2	108	5,455	1	0	2	116	5,488	1	0	2	117
			TFTM	5,075	1	0	2	108	5,450	1	0	2	116	5,484	1	0	2	117
	1000 mA	73W	T2S	7,147	2	0	2	98	7,675	2	0	2	105	7,723	1	0	1	104
			T2M	6,954	2	0	2	95	7,467	2	0	2	102	7,514	2	0	2	103
			T3S	7,057	1	0	2	97	7,579	1	0	2	104	7,627	1	0	2	104
			T3M	7,172	2	0	3	98	7,702	2	0	3	106	7,751	2	0	3	106
			T4M	7,076	1	0	2	97	7,599	1	0	2	104	7,646	1	0	2	105
			TFTM	7,071	1	0	2	97	7,594	1	0	2	104	7,641	1	0	2	105
30C (30 LEDs)	350 mA	36W	T2S	4,160	1	0	1	116	4,467	1	0	1	124	4,494	1	0	1	125
			T2M	4,048	1	0	1	112	4,346	1	0	2	121	4,373	1	0	2	121
			T3S	4,108	1	0	1	114	4,411	1	0	1	123	4,438	1	0	1	123
			T3M	4,174	1	0	2	116	4,483	1	0	2	125	4,510	1	0	2	125
			T4M	4,119	1	0	1	114	4,423	1	0	2	123	4,450	1	0	2	124
			TFTM	4,115	1	0	1	114	4,419	1	0	1	123	4,446	1	0	1	124
	530 mA	54W	T2S	6,001	1	0	1	111	6,444	1	0	1	119	6,484	1	0	1	120
			T2M	5,838	1	0	2	108	6,270	2	0	2	116	6,308	2	0	2	117
			T3S	5,926	1	0	2	110	6,364	1	0	2	118	6,403	1	0	2	119
			T3M	6,023	1	0	2	112	6,467	1	0	2	120	6,507	1	0	2	121
			T4M	5,942	1	0	2	110	6,380	1	0	2	118	6,420	1	0	2	119
			TFTM	5,937	1	0	2	110	6,376	1	0	2	118	6,415	1	0	2	119
	700 mA	71W	T2S	7,403	2	0	2	104	8,170	2	0	2	115	8,221	2	0	2	116
			T2M	7,609	2	0	2	107	7,949	2	0	2	112	7,998	2	0	2	113
			T3S	7,513	1	0	2	106	8,068	1	0	2	114	8,118	1	0	2	114
			T3M	7,635	2	0	3	108	8,199	2	0	3	115	8,250	2	0	3	116
			T4M	7,534	1	0	2	106	8,089	1	0	2	114	8,140	1	0	2	115
			TFTM	7,527	1	0	2	106	8,082	2	0	2	114	8,134	2	0	2	115
	1000 mA	109W	T2S	10,468	2	0	2	96	11,241	2	0	2	103	11,311	2	0	2	104
			T2M	10,184	2	0	3	93	10,936	2	0	3	100	11,005	2	0	3	101
			T3S	10,335	2	0	2	95	11,099	2	0	2	102	11,169	2	0	2	102
			T3M	10,505	2	0	3	96	11,280	2	0	3	103	11,351	2	0	3	104
			T4M	10,365	2	0	2	95	11,129	2	0	2	102	11,198	2	0	2	103
			TFTM	10,356	2	0	2	95	11,121	2	0	3	102	11,190	2	0	3	103

### Note:

Available with phosphor-converted amber LED's (nomenclature AMBPC). These LED's produce light with 97+% >530 nm. Output can be calculated by applying a 0.7 factor to 4000 K lumen values and photometric files.



## Performance Data

### Lumen Ambient Temperature (LAT) Multipliers

Use these factors to determine relative lumen output for average ambient temperatures from 0-40°C (32-104°F).

Ambient		Lumen Multiplier
0°C	32°F	1.02
10°C	50°F	1.01
20°C	68°F	1.00
<b>25°C</b>	<b>77°F</b>	<b>1.00</b>
30°C	86°F	1.00
40°C	104°F	0.98

### Electrical Load

LEDs	Drive Current (mA)	System Watts	Current (A)					
			120V	208V	240V	277V	347V	480V
20C	350	25 W	0.23	0.13	0.12	0.10	-	-
	530	36 W	0.33	0.19	0.17	0.14	-	-
	700	47 W	0.44	0.25	0.22	0.19	-	-
	1000	74 W	0.68	0.39	0.34	0.29	-	-
30C	350	36 W	0.33	0.19	0.17	0.14	-	-
	530	54 W	0.50	0.29	0.25	0.22	-	-
	700	71 W	0.66	0.38	0.33	0.28	0.23	0.16
	1000	109 W	1.01	0.58	0.50	0.44	-	-

### Projected LED Lumen Maintenance

Data references the extrapolated performance projections for the **DSXW2 LED 30C 1000** platform in a **25°C ambient**, based on 10,000 hours of LED testing (tested per IESNA LM-80-08 and projected per IESNA TM-21-11).

To calculate LLF, use the lumen maintenance factor that corresponds to the desired number of operating hours below. For other lumen maintenance values, contact factory.

Operating Hours	0	25,000	50,000	100,000
Lumen Maintenance Factor	1.0	0.95	0.92	0.87

### Motion Sensor Default Settings

Option	Dimmed State	High Level (when triggered)	Photocell Operation	Dwell Time	Ramp-up Time	Ramp-down Time
*PIR or PIRH	3V (37%) Output	10V (100%) Output	Enabled @ 5FC	5 min	3 sec	5 min
PIR1FC3V or PIRH1FC3V	3V (37%) Output	10V (100%) Output	Enabled @ 1FC	5 min	3 sec	5 min

\*for use with Inline Dusk to Dawn or timer

### PER Table

Control	PER (3 wire)	PER5 (5 wire)		PER7 (7 wire)		
			Wire 4/Wire5		Wire 4/Wire5	Wire 6/Wire7
Photocontrol Only (On/Off)	✓	⚠	Wired to dimming leads on driver	⚠	Wired to dimming leads on driver	Wires Capped inside fixture
ROAM	⊘	✓	Wired to dimming leads on driver	⚠	Wired to dimming leads on driver	Wires Capped inside fixture
ROAM with Motion	⊘	⚠	Wired to dimming leads on driver	⚠	Wired to dimming leads on driver	Wires Capped inside fixture
Futureproof*	⊘	⚠	Wired to dimming leads on driver	✓	Wired to dimming leads on driver	Wires Capped inside fixture
Futureproof* with Motion	⊘	⚠	Wired to dimming leads on driver	✓	Wired to dimming leads on driver	Wires Capped inside fixture

✓ Recommended

⊘ Will not work

⚠ Alternate

\*Futureproof means: Ability to change controls in the future.

Isofootcandle plots for the DSXW2 LED 30C 1000 40K. Distances are in units of mounting height (25').

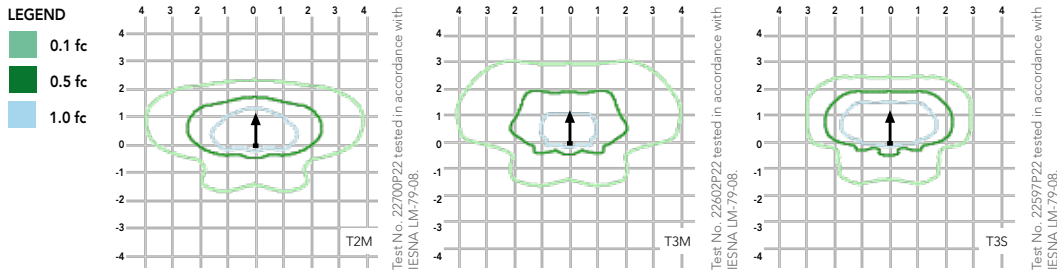

Distribution overlay comparison to 400W metal halide.

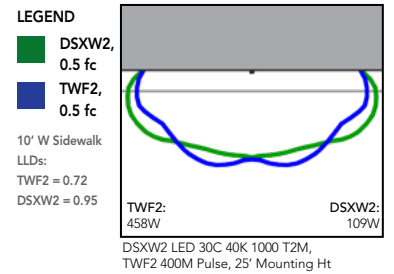

## FEATURES & SPECIFICATIONS

### INTENDED USE

The energy savings, long life and easy-to-install design of the D-Series Wall Size 2 make it the smart choice for building-mounted doorway and pathway illumination for nearly any facility.

### CONSTRUCTION

Two-piece die-cast aluminum housing has integral heat sink fins to optimize thermal management through conductive and convective cooling. Modular design allows for ease of maintenance. The LED driver is mounted to the door to thermally isolate it from the light engines for low operating temperature and long life. Housing is completely sealed against moisture and environmental contaminants (IP65).

### FINISH

Exterior parts are protected by a zinc-infused Super Durable TGIC thermoset powder coat finish that provides superior resistance to corrosion and weathering. A tightly controlled multi-stage process ensures a minimum 3 mils thickness for a finish that can withstand extreme climate changes without cracking or peeling. Available in textured and non-textured finishes.

### OPTICS

Precision-molded proprietary acrylic lenses provide multiple photometric distributions tailored specifically to building mounted applications. Light engines are available in 3000 K (70 min. CRI), 4000 K (70 min. CRI) or 5000 K (70 min. CRI) configurations.

### ELECTRICAL

Light engine(s) consist of 10 high-efficacy LEDs mounted to a metal-core circuit board to maximize heat dissipation and promote long life (L87/100,000 hrs at 25°C). Class 1 electronic drivers have a power factor >90%, THD <20%, and a minimum 2.5KV surge rating. When ordering the SPD option, a separate surge protection device is installed within the luminaire which meets a minimum Category C Low (per ANSI/IEEE C62.41.2).

### INSTALLATION

Included universal mounting bracket attaches securely to any 4" round or square outlet box for quick and easy installation. Luminaire has a slotted gasket wireway and attaches to the mounting bracket via corrosion-resistant screws.

### LISTINGS

CSA certified to U.S. and Canadian standards. Rated for -40°C minimum ambient.

DesignLights Consortium® (DLC) qualified product. Not all versions of this product may be DLC qualified. Please check the DLC Qualified Products List at [www.designlights.org](http://www.designlights.org) to confirm which versions are qualified.

### WARRANTY

Five-year limited warranty. Complete warranty terms located at [www.acuitybrands.com/CustomerResources/Terms\\_and\\_conditions.aspx](http://www.acuitybrands.com/CustomerResources/Terms_and_conditions.aspx).

**Note:** Actual performance may differ as a result of end-user environment and application. All values are design or typical values, measured under laboratory conditions at 25 °C. Specifications subject to change without notice.



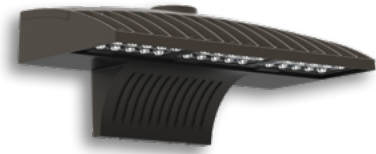

# D-Series Size 2 LED Wall Luminaire



d<sup>series</sup>

## Specifications Luminaire

**Width:** 18-1/2" (47.0 cm) **Weight:** 21 lbs (9.5 kg)

**Depth:** 10" (25.4 cm)

**Height:** 7-5/8" (19.4 cm)

## Back Box (BBW)

**Width:** 5-1/2" (14.0 cm) **BBW Weight:** 1 lbs (0.5 kg)

**Depth:** 1-1/2" (3.8 cm)

**Height:** 4" (10.2 cm)

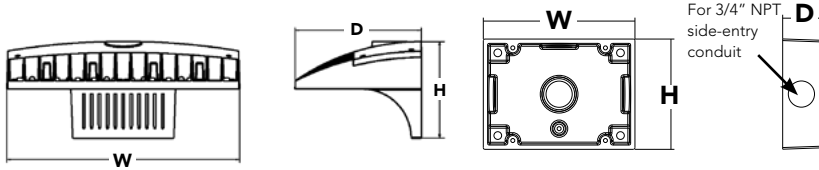

Catalog Number
Notes
Type

Hit the Tab key or mouse over the page to see all interactive elements.

## A+ Capable Luminaire

This item is an A+ capable luminaire, which has been designed and tested to provide consistent color appearance and system-level interoperability.

- All configurations of this luminaire meet the Acuity Brands' specification for chromatic consistency
- This luminaire is A+ Certified when ordered with DTL<sup>®</sup> controls marked by a shaded background. DTL DLL equipped luminaires meet the A+ specification for luminaire to photocontrol interoperability<sup>1</sup>
- This luminaire is part of an A+ Certified solution for ROAM<sup>®</sup> or XPoint<sup>™</sup> Wireless control networks, providing out-of-the-box control compatibility with simple commissioning, when ordered with drivers and control options marked by a shaded background<sup>1</sup>

To learn more about A+, visit [www.acuitybrands.com/aplus](http://www.acuitybrands.com/aplus).

1. See ordering tree for details.
2. A+ Certified Solutions for ROAM require the order of one ROAM node per luminaire. Sold Separately: [Link to Roam](#); [Link to DTL DLL](#)

A+ Capable options indicated by this color background.

## Ordering Information

EXAMPLE: DSXW2 LED 30C 700 40K T3M MVOLT DDBTXD

Series	LEDs	Drive Current	Color temperature	Distribution	Voltage	Mounting	Control Options
<b>DSXW2 LED</b>							
<b>DSXW2 LED</b>	20C 20 LEDs (two engines) <b>30C</b> 30 LEDs (three engines)	350 350 mA <b>530</b> 530 mA 700 700 mA 1000 1000 mA <sup>1</sup> (1 A)	30K 3000 K 40K 4000 K <b>50K</b> 5000 K AMBPC Amber phosphor converted <sup>2</sup>	T2S Type II Short T2M Type II Medium T3S Type III Short T3M Type III Medium <b>T4M</b> Type IV Medium TFTM Forward Throw Medium	<b>MVOLT</b> <sup>3</sup> 120 <sup>4</sup> 208 <sup>4</sup> 240 <sup>4</sup> 277 <sup>4</sup> 347 <sup>4,5</sup> 480 <sup>4,5</sup>	<b>Shipped included</b> (blank) Surface mounting bracket  <b>Shipped separately</b> <sup>6</sup> BBW Surface-mounted back box (for conduit entry)	<b>Shipped installed</b> PE Photoelectric cell, button type <sup>7</sup> <b>PER</b> NEMA twist-lock receptacle only (control ordered separate) <sup>8</sup> <b>PER5</b> Five-wire receptacle only (control ordered separate) <sup>8,9</sup> <b>PER7</b> Seven-wire receptacle only (control ordered separate) <sup>8,9</sup> DMG 0-10v dimming wires pulled outside fixture (for use with an external control, ordered separately) PIR 180° motion/ambient light sensor, <15' mtg ht <sup>10,11</sup> PIRH 180° motion/ambient light sensor, 15-30' mtg ht <sup>10,11</sup> PIR1FC3V Motion/ambient sensor, 8-15' mounting height, ambient sensor enabled at 1fc <sup>11,12</sup> PIRH1FC3V Motion/ambient sensor, 15-30' mounting height, ambient sensor enabled at 1fc <sup>11,12</sup>

### Other Options

### Finish (required)

<b>Shipped installed</b>	<b>Shipped separately</b> <sup>13</sup>	DDBXD Dark bronze	DSSXD Sandstone	DWHGXD Textured white
SF Single fuse (120, 277, 347V) <sup>3</sup>	BSW Bird-deterrent spikes	DBLXD Black	DDBTXD Textured dark bronze	DSSTXD Textured sandstone
DF Double fuse (208, 240, 480V) <sup>3</sup>	VG Vandal guard	DNAXD Natural aluminum	DBLBXD Textured black	
HS House-side shield <sup>4</sup>		DWHXD White	DNATXD Textured natural aluminum	
SPD Separate surge protection <sup>13</sup>				



## Ordering Information

### Accessories

Ordered and shipped separately.

DLL127F 1.5 JU	Photozell - SSL twist-lock (120-277V) <sup>14</sup>
DLL347F 1.5 CUL JU	Photozell - SSL twist-lock (347V) <sup>14</sup>
DLL480F 1.5 CUL JU	Photozell - SSL twist-lock (480V) <sup>14</sup>
DSHORT SBK U	Shorting cap (Included when ordering PER, PERS or PER7) <sup>14</sup>
DSXWHS U	House-side shield (one per light engine)
DSXWBSW U	Bird-deterrent spikes
DSXW2VG U	Vandal guard accessory
DSXW2BBW	Back box accessory
DBBXD U	(specify finish)

For more control options, visit [DTL](#) and [ROAM](#) online.

### NOTES

- 1000mA is not available with AMBPC.
- AMBPC is not available with 1000mA.
- MVOLT driver operates on any line voltage from 120-277V (50/60 Hz).
- Single fuse (SF) requires 120, 277 or 347 voltage option. Double fuse (DF) requires 208, 240 or 480 voltage option.
- Available with 30 LED/700mA options only (DSXW2 LED 30C 700). DMG option not available.
- Also available as a separate accessory; see Accessories information.
- Photocontrol (PE) requires 120, 208, 240, 277 or 347 voltage option. Not available with motion/ambient light sensors (PIR or PIRH).
- Photozell ordered and shipped as a separate line item from Acuity Brands Controls. See accessories. Shorting Cap included.
- If ROAM® node required, it must be ordered and shipped as a separate line item from Acuity Brands Controls. Shorting Cap included.
- Reference Motion Sensor table on page 3.
- Reference PER Table on page 3 for functionality.
- PIR and PIR1FC3V specify the [SensorSwitch SBGR-10-ODP](#) control; PIRH and PIRH1FC3V specify the [SensorSwitch SBGR-6-ODP](#) control; see [Motion Sensor Guide](#) for details. Dimming driver standard. Not available with PER5 or PER7. Separate on/off required.
- See the electrical section on page 2 for more details.
- Requires luminaire to be specified with PER option. Ordered and shipped as a separate line item. See PER Table.

## Performance Data

### Lumen Output

Lumen values are from photometric tests performed in accordance with IESNA LM-79-08. Data is considered to be representative of the configurations shown, within the tolerances allowed by Lighting Facts. Contact factory for performance data on any configurations not shown here.

LEDs	Drive Current (mA)	System Watts	Dist. Type	30K					40K					50K				
				Lumens	B	U	G	LPW	Lumens	B	U	G	LPW	Lumens	B	U	G	LPW
20C (20 LEDs)	350 mA	25W	T2S	2,783	1	0	1	111	2,989	1	0	1	120	3,008	1	0	1	120
			T2M	2,709	1	0	1	108	2,908	1	0	1	116	2,926	1	0	1	117
			T3S	2,748	1	0	1	110	2,951	1	0	1	118	2,969	1	0	1	119
			T3M	2,793	1	0	1	112	2,999	1	0	1	120	3,018	1	0	1	121
			T4M	2,756	1	0	1	110	2,959	1	0	1	118	2,977	1	0	1	119
			TFTM	2,753	1	0	1	110	2,956	1	0	1	118	2,975	1	0	1	119
	530 mA	36W	T2S	4,030	1	0	1	112	4,327	1	0	1	120	4,354	1	0	1	121
			T2M	3,920	1	0	1	109	4,210	1	0	1	117	4,236	1	0	1	118
			T3S	3,978	1	0	1	111	4,272	1	0	1	119	4,299	1	0	1	119
			T3M	4,044	1	0	2	112	4,343	1	0	2	121	4,370	1	0	2	121
			T4M	3,990	1	0	1	111	4,284	1	0	1	119	4,310	1	0	1	120
			TFTM	3,987	1	0	1	111	4,281	1	0	1	119	4,308	1	0	1	120
	700 mA	47W	T2S	5,130	1	0	1	109	5,509	1	0	1	117	5,544	1	0	1	118
			T2M	4,991	1	0	2	106	5,360	1	0	2	114	5,393	1	0	2	115
			T3S	5,066	1	0	1	108	5,440	1	0	1	116	5,474	1	0	1	116
			T3M	5,148	1	0	2	110	5,529	1	0	2	118	5,563	1	0	2	118
			T4M	5,080	1	0	2	108	5,455	1	0	2	116	5,488	1	0	2	117
			TFTM	5,075	1	0	2	108	5,450	1	0	2	116	5,484	1	0	2	117
	1000 mA	73W	T2S	7,147	2	0	2	98	7,675	2	0	2	105	7,723	1	0	1	104
			T2M	6,954	2	0	2	95	7,467	2	0	2	102	7,514	2	0	2	103
			T3S	7,057	1	0	2	97	7,579	1	0	2	104	7,627	1	0	2	104
			T3M	7,172	2	0	3	98	7,702	2	0	3	106	7,751	2	0	3	106
			T4M	7,076	1	0	2	97	7,599	1	0	2	104	7,646	1	0	2	105
			TFTM	7,071	1	0	2	97	7,594	1	0	2	104	7,641	1	0	2	105
30C (30 LEDs)	350 mA	36W	T2S	4,160	1	0	1	116	4,467	1	0	1	124	4,494	1	0	1	125
			T2M	4,048	1	0	1	112	4,346	1	0	2	121	4,373	1	0	2	121
			T3S	4,108	1	0	1	114	4,411	1	0	1	123	4,438	1	0	1	123
			T3M	4,174	1	0	2	116	4,483	1	0	2	125	4,510	1	0	2	125
			T4M	4,119	1	0	1	114	4,423	1	0	2	123	4,450	1	0	2	124
			TFTM	4,115	1	0	1	114	4,419	1	0	1	123	4,446	1	0	1	124
	530 mA	54W	T2S	6,001	1	0	1	111	6,444	1	0	1	119	6,484	1	0	1	120
			T2M	5,838	1	0	2	108	6,270	2	0	2	116	6,308	2	0	2	117
			T3S	5,926	1	0	2	110	6,364	1	0	2	118	6,403	1	0	2	119
			T3M	6,023	1	0	2	112	6,467	1	0	2	120	6,507	1	0	2	121
			T4M	5,942	1	0	2	110	6,380	1	0	2	118	6,420	1	0	2	119
			TFTM	5,937	1	0	2	110	6,376	1	0	2	118	6,415	1	0	2	119
	700 mA	71W	T2S	7,403	2	0	2	104	8,170	2	0	2	115	8,221	2	0	2	116
			T2M	7,609	2	0	2	107	7,949	2	0	2	112	7,998	2	0	2	113
			T3S	7,513	1	0	2	106	8,068	1	0	2	114	8,118	1	0	2	114
			T3M	7,635	2	0	3	108	8,199	2	0	3	115	8,250	2	0	3	116
			T4M	7,534	1	0	2	106	8,089	1	0	2	114	8,140	1	0	2	115
			TFTM	7,527	1	0	2	106	8,082	2	0	2	114	8,134	2	0	2	115
	1000 mA	109W	T2S	10,468	2	0	2	96	11,241	2	0	2	103	11,311	2	0	2	104
			T2M	10,184	2	0	3	93	10,936	2	0	3	100	11,005	2	0	3	101
			T3S	10,335	2	0	2	95	11,099	2	0	2	102	11,169	2	0	2	102
			T3M	10,505	2	0	3	96	11,280	2	0	3	103	11,351	2	0	3	104
			T4M	10,365	2	0	2	95	11,129	2	0	2	102	11,198	2	0	2	103
			TFTM	10,356	2	0	2	95	11,121	2	0	3	102	11,190	2	0	3	103

### Note:

Available with phosphor-converted amber LED's (nomenclature AMBPC). These LED's produce light with 97+% >530 nm. Output can be calculated by applying a 0.7 factor to 4000 K lumen values and photometric files.



## Performance Data

### Lumen Ambient Temperature (LAT) Multipliers

Use these factors to determine relative lumen output for average ambient temperatures from 0-40°C (32-104°F).

Ambient		Lumen Multiplier
0°C	32°F	1.02
10°C	50°F	1.01
20°C	68°F	1.00
<b>25°C</b>	<b>77°F</b>	<b>1.00</b>
30°C	86°F	1.00
40°C	104°F	0.98

### Electrical Load

LEDs	Drive Current (mA)	System Watts	Current (A)					
			120V	208V	240V	277V	347V	480V
20C	350	25 W	0.23	0.13	0.12	0.10	-	-
	530	36 W	0.33	0.19	0.17	0.14	-	-
	700	47 W	0.44	0.25	0.22	0.19	-	-
	1000	74 W	0.68	0.39	0.34	0.29	-	-
30C	350	36 W	0.33	0.19	0.17	0.14	-	-
	530	54 W	0.50	0.29	0.25	0.22	-	-
	700	71 W	0.66	0.38	0.33	0.28	0.23	0.16
	1000	109 W	1.01	0.58	0.50	0.44	-	-

### Projected LED Lumen Maintenance

Data references the extrapolated performance projections for the **DSXW2 LED 30C 1000** platform in a **25°C ambient**, based on 10,000 hours of LED testing (tested per IESNA LM-80-08 and projected per IESNA TM-21-11).

To calculate LLF, use the lumen maintenance factor that corresponds to the desired number of operating hours below. For other lumen maintenance values, contact factory.

Operating Hours	0	25,000	50,000	100,000
Lumen Maintenance Factor	1.0	0.95	0.92	0.87

### Motion Sensor Default Settings

Option	Dimmed State	High Level (when triggered)	Photocell Operation	Dwell Time	Ramp-up Time	Ramp-down Time
*PIR or PIRH	3V (37%) Output	10V (100%) Output	Enabled @ 5FC	5 min	3 sec	5 min
PIR1FC3V or PIRH1FC3V	3V (37%) Output	10V (100%) Output	Enabled @ 1FC	5 min	3 sec	5 min

\*for use with Inline Dusk to Dawn or timer

### PER Table

Control	PER (3 wire)	PER5 (5 wire)		PER7 (7 wire)		
			Wire 4/Wire5		Wire 4/Wire5	Wire 6/Wire7
Photocontrol Only (On/Off)	✓	⚠	Wired to dimming leads on driver	⚠	Wired to dimming leads on driver	Wires Capped inside fixture
ROAM	⊘	✓	Wired to dimming leads on driver	⚠	Wired to dimming leads on driver	Wires Capped inside fixture
ROAM with Motion	⊘	⚠	Wired to dimming leads on driver	⚠	Wired to dimming leads on driver	Wires Capped inside fixture
Futureproof*	⊘	⚠	Wired to dimming leads on driver	✓	Wired to dimming leads on driver	Wires Capped inside fixture
Futureproof* with Motion	⊘	⚠	Wired to dimming leads on driver	✓	Wired to dimming leads on driver	Wires Capped inside fixture

✓ Recommended

⊘ Will not work

⚠ Alternate

\*Futureproof means: Ability to change controls in the future.

Isofootcandle plots for the DSXW2 LED 30C 1000 40K. Distances are in units of mounting height (25').

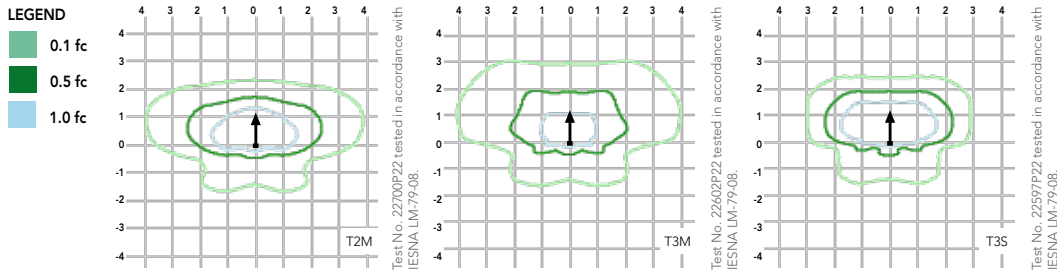

Distribution overlay comparison to 400W metal halide.

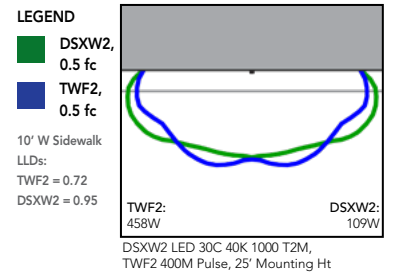

## FEATURES & SPECIFICATIONS

### INTENDED USE

The energy savings, long life and easy-to-install design of the D-Series Wall Size 2 make it the smart choice for building-mounted doorway and pathway illumination for nearly any facility.

### CONSTRUCTION

Two-piece die-cast aluminum housing has integral heat sink fins to optimize thermal management through conductive and convective cooling. Modular design allows for ease of maintenance. The LED driver is mounted to the door to thermally isolate it from the light engines for low operating temperature and long life. Housing is completely sealed against moisture and environmental contaminants (IP65).

### FINISH

Exterior parts are protected by a zinc-infused Super Durable TGIC thermoset powder coat finish that provides superior resistance to corrosion and weathering. A tightly controlled multi-stage process ensures a minimum 3 mils thickness for a finish that can withstand extreme climate changes without cracking or peeling. Available in textured and non-textured finishes.

### OPTICS

Precision-molded proprietary acrylic lenses provide multiple photometric distributions tailored specifically to building mounted applications. Light engines are available in 3000 K (70 min. CRI), 4000 K (70 min. CRI) or 5000 K (70 min. CRI) configurations.

### ELECTRICAL

Light engine(s) consist of 10 high-efficacy LEDs mounted to a metal-core circuit board to maximize heat dissipation and promote long life (L87/100,000 hrs at 25°C). Class 1 electronic drivers have a power factor >90%, THD <20%, and a minimum 2.5KV surge rating. When ordering the SPD option, a separate surge protection device is installed within the luminaire which meets a minimum Category C Low (per ANSI/IEEE C62.41.2).

### INSTALLATION

Included universal mounting bracket attaches securely to any 4" round or square outlet box for quick and easy installation. Luminaire has a slotted gasket wireway and attaches to the mounting bracket via corrosion-resistant screws.

### LISTINGS

CSA certified to U.S. and Canadian standards. Rated for -40°C minimum ambient.

DesignLights Consortium® (DLC) qualified product. Not all versions of this product may be DLC qualified. Please check the DLC Qualified Products List at [www.designlights.org](http://www.designlights.org) to confirm which versions are qualified.

### WARRANTY

Five-year limited warranty. Complete warranty terms located at [www.acuitybrands.com/CustomerResources/Terms\\_and\\_conditions.aspx](http://www.acuitybrands.com/CustomerResources/Terms_and_conditions.aspx).

**Note:** Actual performance may differ as a result of end-user environment and application. All values are design or typical values, measured under laboratory conditions at 25 °C. Specifications subject to change without notice.



# CNY LED

## LED Canopy/Ceiling Luminaire



Catalog Number

Notes

Type

Hit the Tab key or mouse over the page to see all interactive elements.

### Specifications

	CNY LED P0/P1/P2	CNY LED P3/P4
<b>Width:</b>	10"	14"
<b>Height:</b>	4.5"	6"
<b>Depth:</b>	10"	14"
<b>Weight:</b>	6.5lbs	13lbs

### Introduction

The CNY LED canopy luminaires are energy efficient and budget friendly, perfect for replacing up to 400W metal halide luminaires while saving up to 80% energy costs. Quick mount mechanism significantly reduces the installation time. An LED array and translucent lens create uniform and visually comfortable illumination. CNY LED luminaires are DLC Premium listed and deliver quick payback!

### Ordering Information

**EXAMPLE: CNY LED P1 50K MVOLT DDB**

CNY LED				
Series	Performance Package	Color Temperature <sup>3</sup>	Voltage	Finish
<b>CNY LED</b>	<b>P0</b> 3,500 lumens <sup>1</sup> <b>P1</b> 4,500 lumens <sup>2</sup> <b>P2</b> 6,600 lumens <b>P3</b> 11,100 lumens <b>P4</b> 14,000 lumens	40K 4000K <b>50K</b> <b>5000K<sup>4</sup></b>	<b>MVOLT<sup>5</sup></b> <b>120-277V</b>	<b>DDB</b> Dark bronze <b>WH<sup>6</sup></b> White

#### Accessories

Ordered and shipped separately.

CNYBCP 14 Inch x 14 Inch Beauty Cover Plate

#### NOTES

1. The combination of P0 50K WH is not available.
2. Not available in 50K.
3. Correlated color temperature (CCT) shown is nominal per ANSI C78, 377-2008.
4. Not available in P1 performance package.
5. MVOLT driver operates on any line voltage from 120-277V (50/60 Hz).
6. Available with P0 or P1 only.

### FEATURES & SPECIFICATIONS

#### INTENDED USE

CNY LED luminaires are ideal, energy-efficient replacements for up to 400W MH canopy or ceiling luminaires. The CNY LED provides years of maintenance-free illumination for schools, malls, offices, parking areas, covered walkways and loading docks.

#### CONSTRUCTION

Cast-aluminum, corrosion-resistant housing with polyester powder paint for lasting durability. Castings are sealed with a one-piece gasket. Rated for outdoor installations, -40°C minimum ambient. Frosted lens is designed for uniform light distribution.

#### ELECTRICAL

Includes an MVOLT (120-277V) driver. LEDs maintain 70% of light output at 50,000 or more hours of service life (L70/50,000 hours).

#### INSTALLATION

Mounts to a recessed junction box or surface mount with three conduit entry points. Can be pendant mounted with ¾ NPT pendant stem provided by others. Quick mount mechanism significantly reduces installation time - no need to open the luminaire for installation.

#### LISTINGS

UL Listed to U.S. and Canadian safety standards for wet locations. Tested in accordance with IESNA LM-79 and LM-80 standards. DesignLights Consortium® (DLC) Premium qualified product. Not all versions of this product may be DLC Premium qualified or DLC qualified. Please check the DLC Qualified Products List at [www.designlights.org/QPL](http://www.designlights.org/QPL) to confirm which versions are qualified. Can be used to comply with California Title 24 Part 6 High Efficacy LED light Source Requirements.

#### WARRANTY

Five-year limited warranty. Complete warranty terms located at: [www.acuitybrands.com/CustomerResources/Terms\\_and\\_conditions.aspx](http://www.acuitybrands.com/CustomerResources/Terms_and_conditions.aspx).

**Note:** Actual performance may differ as a result of end-user environment and application. All values are design or typical values, measured under laboratory conditions at 25 °C. Specifications subject to change without notice.



# Photometric Diagrams

Full photometric data report available within 2 weeks from request. Contact [Acuity Tech Support](#).

CNY LED - Mounting height = 10

## LEGEND

- 0.1 fc
- 0.2 fc
- 0.5 fc
- 1.0 fc

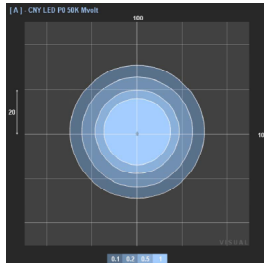

CNY LED P0

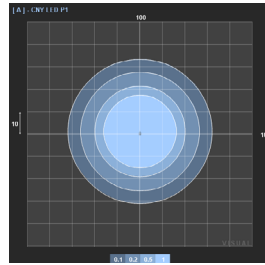

CNY LED P1

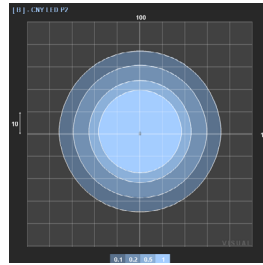

CNY LED P2

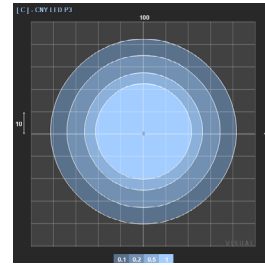

CNY LED P3

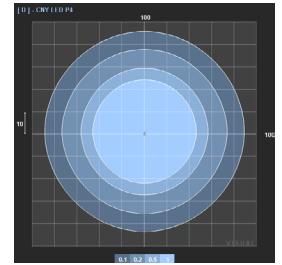

CNY LED P4

# Performance Data

Performance Package	Lumens	Input Power	Lumens Per Watt
CNY LED P0	3,500	27W	130
CNY LED P1	4,500	35W	127
CNY LED P2	6,600	52W	128
CNY LED P3	11,000	86W	128
CNY LED P4	13,900	109W	128

# Line Art

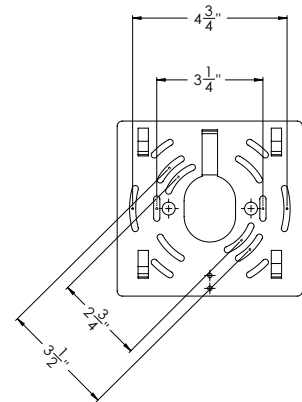
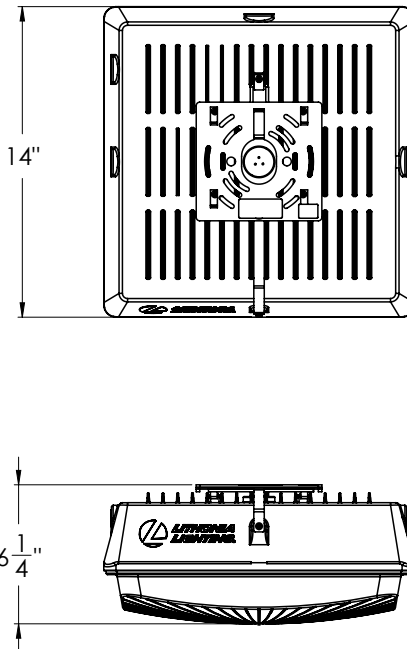
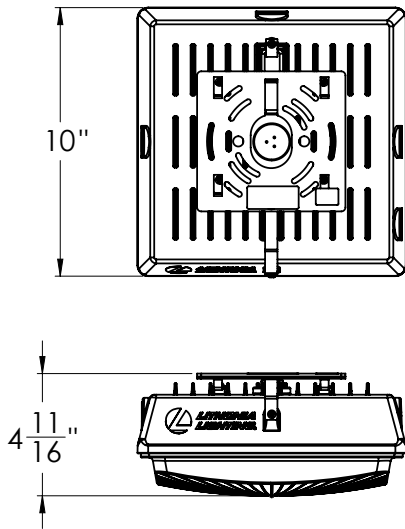





# CNY LED

## LED Canopy/Ceiling Luminaire



Catalog Number

Notes

Type

Hit the Tab key or mouse over the page to see all interactive elements.

### Specifications

	CNY LED P0/P1/P2	CNY LED P3/P4
<b>Width:</b>	10"	14"
<b>Height:</b>	4.5"	6"
<b>Depth:</b>	10"	14"
<b>Weight:</b>	6.5lbs	13lbs

### Introduction

The CNY LED canopy luminaires are energy efficient and budget friendly, perfect for replacing up to 400W metal halide luminaires while saving up to 80% energy costs. Quick mount mechanism significantly reduces the installation time. An LED array and translucent lens create uniform and visually comfortable illumination. CNY LED luminaires are DLC Premium listed and deliver quick payback!

### Ordering Information

**EXAMPLE: CNY LED P1 50K MVOLT DDB**

CNY LED				
Series	Performance Package	Color Temperature <sup>3</sup>	Voltage	Finish
<b>CNY LED</b>	P0 3,500 lumens <sup>1</sup> <b>P1 4,500 lumens<sup>2</sup></b> P2 6,600 lumens P3 11,100 lumens P4 14,000 lumens	40K 4000K <b>50K 5000K<sup>4</sup></b>	<b>MVOLT<sup>5</sup> 120-277V</b>	DDB Dark bronze WH <sup>6</sup> White

#### Accessories

Ordered and shipped separately.

CNYBCP 14 Inch x 14 Inch Beauty Cover Plate

#### NOTES

1. The combination of P0 50K WH is not available.
2. Not available in 50K.
3. Correlated color temperature (CCT) shown is nominal per ANSI C78, 377-2008.
4. Not available in P1 performance package.
5. MVOLT driver operates on any line voltage from 120-277V (50/60 Hz).
6. Available with P0 or P1 only.

### FEATURES & SPECIFICATIONS

#### INTENDED USE

CNY LED luminaires are ideal, energy-efficient replacements for up to 400W MH canopy or ceiling luminaires. The CNY LED provides years of maintenance-free illumination for schools, malls, offices, parking areas, covered walkways and loading docks.

#### CONSTRUCTION

Cast-aluminum, corrosion-resistant housing with polyester powder paint for lasting durability. Castings are sealed with a one-piece gasket. Rated for outdoor installations, -40°C minimum ambient. Frosted lens is designed for uniform light distribution.

#### ELECTRICAL

Includes an MVOLT (120-277V) driver. LEDs maintain 70% of light output at 50,000 or more hours of service life (L70/50,000 hours).

#### INSTALLATION

Mounts to a recessed junction box or surface mount with three conduit entry points. Can be pendant mounted with ¾ NPT pendant stem provided by others. Quick mount mechanism significantly reduces installation time - no need to open the luminaire for installation.

#### LISTINGS

UL Listed to U.S. and Canadian safety standards for wet locations. Tested in accordance with IESNA LM-79 and LM-80 standards. DesignLights Consortium® (DLC) Premium qualified product. Not all versions of this product may be DLC Premium qualified or DLC qualified. Please check the DLC Qualified Products List at [www.designlights.org/QPL](http://www.designlights.org/QPL) to confirm which versions are qualified. Can be used to comply with California Title 24 Part 6 High Efficacy LED light Source Requirements.

#### WARRANTY

Five-year limited warranty. Complete warranty terms located at: [www.acuitybrands.com/CustomerResources/Terms\\_and\\_conditions.aspx](http://www.acuitybrands.com/CustomerResources/Terms_and_conditions.aspx).

**Note:** Actual performance may differ as a result of end-user environment and application. All values are design or typical values, measured under laboratory conditions at 25 °C. Specifications subject to change without notice.



# Photometric Diagrams

Full photometric data report available within 2 weeks from request. Contact [Acuity Tech Support](#).

CNY LED - Mounting height = 10

## LEGEND

- 0.1 fc
- 0.2 fc
- 0.5 fc
- 1.0 fc

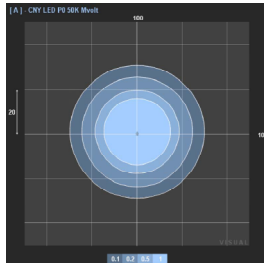

CNY LED P0

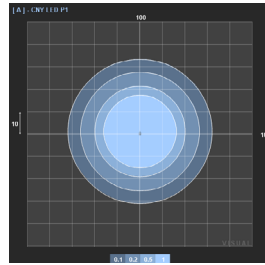

CNY LED P1

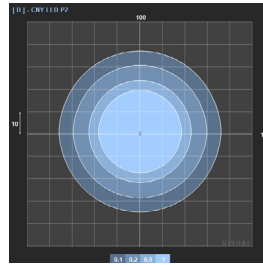

CNY LED P2

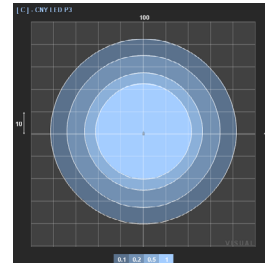

CNY LED P3

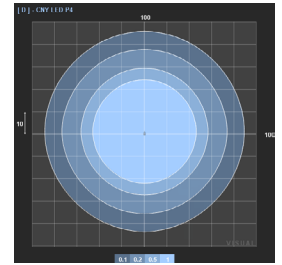

CNY LED P4

# Performance Data

Performance Package	Lumens	Input Power	Lumens Per Watt
CNY LED P0	3,500	27W	130
CNY LED P1	4,500	35W	127
CNY LED P2	6,600	52W	128
CNY LED P3	11,000	86W	128
CNY LED P4	13,900	109W	128

# Line Art

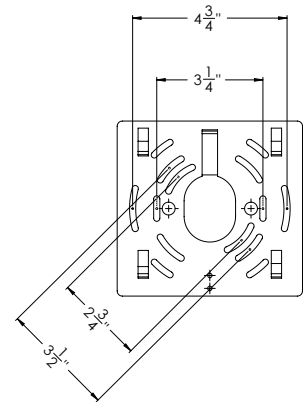
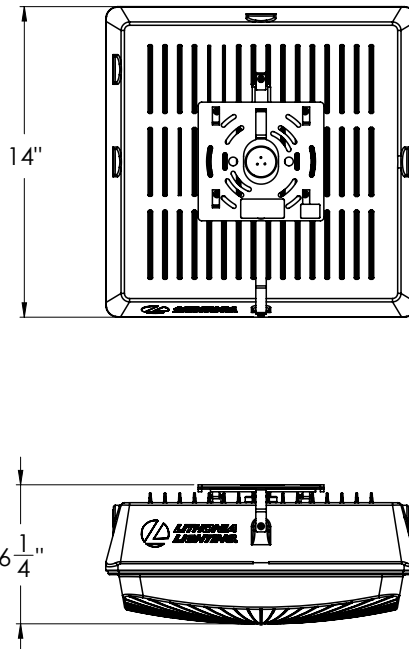
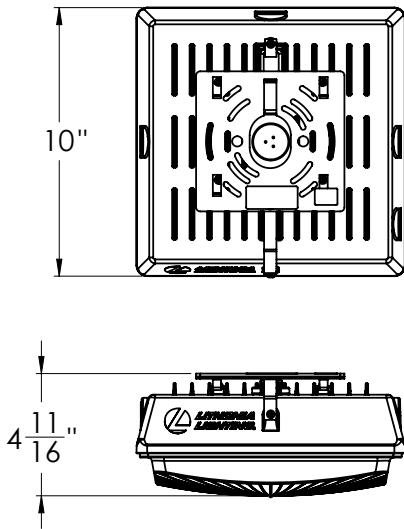



# CNY LED

## LED Canopy/Ceiling Luminaire



Catalog Number

Notes

Type

Hit the Tab key or mouse over the page to see all interactive elements.

### Specifications

	CNY LED P0/P1/P2	CNY LED P3/P4
<b>Width:</b>	10"	14"
<b>Height:</b>	4.5"	6"
<b>Depth:</b>	10"	14"
<b>Weight:</b>	6.5lbs	13lbs

### Introduction

The CNY LED canopy luminaires are energy efficient and budget friendly, perfect for replacing up to 400W metal halide luminaires while saving up to 80% energy costs. Quick mount mechanism significantly reduces the installation time. An LED array and translucent lens create uniform and visually comfortable illumination. CNY LED luminaires are DLC Premium listed and deliver quick payback!

### Ordering Information

**EXAMPLE: CNY LED P1 50K MVOLT DDB**

CNY LED				
Series	Performance Package	Color Temperature <sup>3</sup>	Voltage	Finish
<b>CNY LED</b>	P0 3,500 lumens <sup>1</sup> P1 4,500 lumens <sup>2</sup> <b>P2 6,600 lumens</b> P3 11,100 lumens P4 14,000 lumens	40K 4000K <b>50K 5000K<sup>4</sup></b>	<b>MVOLT<sup>5</sup> 120-277V</b>	DDB Dark bronze WH <sup>6</sup> White

#### Accessories

Ordered and shipped separately.

CNYBCP 14 Inch x 14 Inch Beauty Cover Plate

#### NOTES

1. The combination of P0 50K WH is not available.
2. Not available in 50K.
3. Correlated color temperature (CCT) shown is nominal per ANSI C78, 377-2008.
4. Not available in P1 performance package.
5. MVOLT driver operates on any line voltage from 120-277V (50/60 Hz).
6. Available with P0 or P1 only.

### FEATURES & SPECIFICATIONS

#### INTENDED USE

CNY LED luminaires are ideal, energy-efficient replacements for up to 400W MH canopy or ceiling luminaires. The CNY LED provides years of maintenance-free illumination for schools, malls, offices, parking areas, covered walkways and loading docks.

#### CONSTRUCTION

Cast-aluminum, corrosion-resistant housing with polyester powder paint for lasting durability. Castings are sealed with a one-piece gasket. Rated for outdoor installations, -40°C minimum ambient. Frosted lens is designed for uniform light distribution.

#### ELECTRICAL

Includes an MVOLT (120-277V) driver. LEDs maintain 70% of light output at 50,000 or more hours of service life (L70/50,000 hours).

#### INSTALLATION

Mounts to a recessed junction box or surface mount with three conduit entry points. Can be pendant mounted with ¾ NPT pendant stem provided by others. Quick mount mechanism significantly reduces installation time - no need to open the luminaire for installation.

#### LISTINGS

UL Listed to U.S. and Canadian safety standards for wet locations. Tested in accordance with IESNA LM-79 and LM-80 standards. DesignLights Consortium® (DLC) Premium qualified product. Not all versions of this product may be DLC Premium qualified or DLC qualified. Please check the DLC Qualified Products List at [www.designlights.org/QPL](http://www.designlights.org/QPL) to confirm which versions are qualified. Can be used to comply with California Title 24 Part 6 High Efficacy LED light Source Requirements.

#### WARRANTY

Five-year limited warranty. Complete warranty terms located at: [www.acuitybrands.com/CustomerResources/Terms\\_and\\_conditions.aspx](http://www.acuitybrands.com/CustomerResources/Terms_and_conditions.aspx).

**Note:** Actual performance may differ as a result of end-user environment and application. All values are design or typical values, measured under laboratory conditions at 25 °C. Specifications subject to change without notice.



# Photometric Diagrams

Full photometric data report available within 2 weeks from request. Contact [Acuity Tech Support](#).

CNY LED - Mounting height = 10

## LEGEND

- 0.1 fc
- 0.2 fc
- 0.5 fc
- 1.0 fc

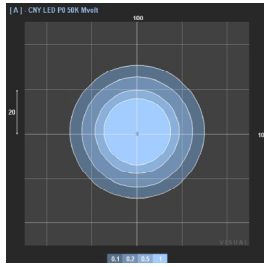

CNY LED P0

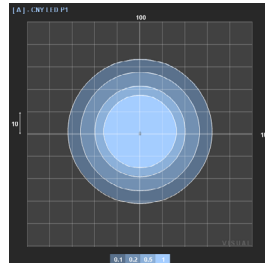

CNY LED P1

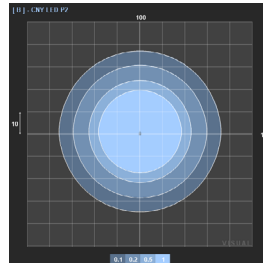

CNY LED P2

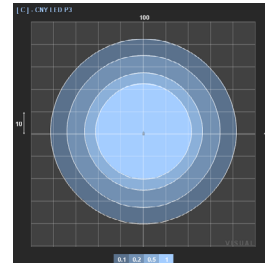

CNY LED P3

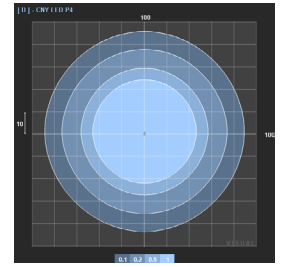

CNY LED P4

# Performance Data

Performance Package	Lumens	Input Power	Lumens Per Watt
CNY LED P0	3,500	27W	130
CNY LED P1	4,500	35W	127
CNY LED P2	6,600	52W	128
CNY LED P3	11,000	86W	128
CNY LED P4	13,900	109W	128

# Line Art

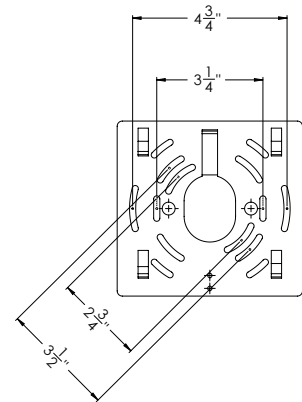
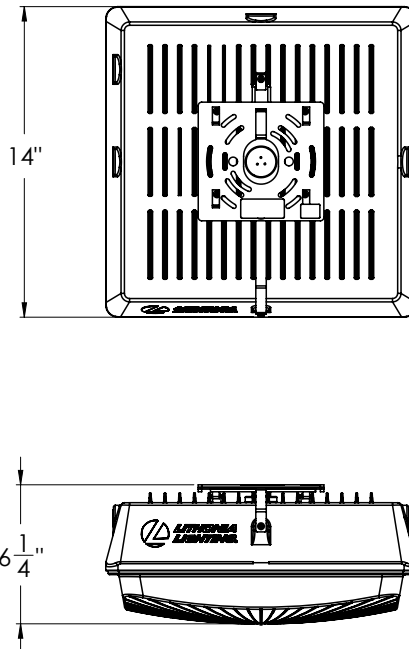
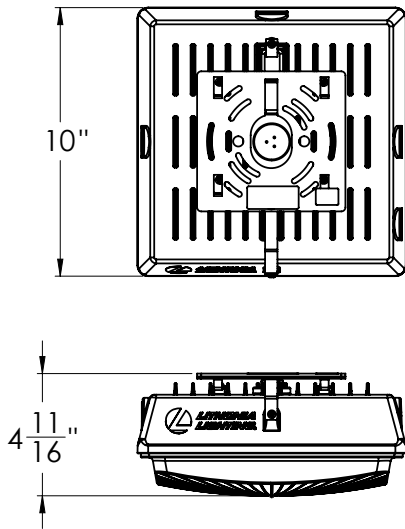



## FEATURES & SPECIFICATIONS

**INTENDED USE** — Typical applications include corridors, lobbies, conference rooms and private offices.

**CONSTRUCTION** — Galvanized steel mounting/plaster frame; galvanized steel junction box with bottom-hinged access covers and spring latches. Reflectors are retained by torsion springs.

Vertically adjustable mounting brackets with commercial bar hangers provide 3-3/4" total adjustment. Two combination 1/2"-3/4" and four 1/2" knockouts for straight-through conduit runs. Capacity: 8 (4 in, 4 out). No. 12 AWG conductors, rated for 90°C.

Accommodates 12"-24" joist spacing.

Passive cooling thermal management for 25°C standard; high ambient (40°C) option available. Light engine and drivers are accessible from above or below ceiling.

Max ceiling thickness 1-1/2".

**OPTICS** — LEDs are binned to a 3-step SDCM; 80 CRI minimum. 90 CRI optional.

LED light source concealed with diffusing optical lens.

General illumination lighting with 1.0 S/MH and 55° cutoff to source and source image.

Self-flanged anodized reflectors in specular, semi-specular, or matte diffuse finishes. Also available in white and black painted reflectors.

**ELECTRICAL** — Multi-volt (120-277V, 50/60Hz) 0-10V dimming drivers mounted to junction box, 10% or 1% minimum dimming level available.

0-10V dimming fixture requires two (2) additional low-voltage wires to be pulled.

70% lumen maintenance at 60,000 hours.

**LISTINGS** — Certified to US and Canadian safety standards. Wet location standard (covered ceiling). IP55 rated. ENERGY STAR® certified product.

**WARRANTY** — 5-year limited warranty. Complete warranty terms located at:

[www.acuitybrands.com/CustomerResources/Terms\\_and\\_conditions.aspx](http://www.acuitybrands.com/CustomerResources/Terms_and_conditions.aspx)

**Note:** Actual performance may differ as a result of end-user environment and application.

All values are design or typical values, measured under laboratory conditions at 25 °C.

Specifications subject to change without notice.

Catalog Number
Notes
Type

# LDN6

**6" OPEN and WALLWASH LED  
Non-IC  
New Construction Downlight**

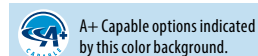
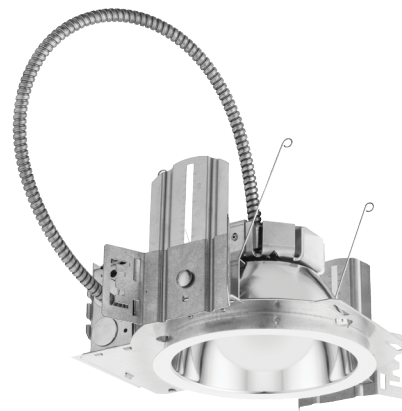

### ORDERING INFORMATION

Lead times will vary depending on options selected. Consult with your sales representative.

**Example:** LDN6 35/15 L06AR LSS MVOLT EZ10

LDN6		Color temperature		Lumens <sup>1</sup>		Aperture/Trim Color		Finish		Voltage	
<b>Series</b>	LDN6 6" round	27/ 2700K	30/ 3000K	05 500 lumens	25 2500 lumens	<b>L06</b> Downlight	<b>AR</b> Clear	<b>LSS</b> Semi-specular	<b>MVOLT</b> Multi-volt	120 120V	
		35/ 3500K	40/ 4000K	<b>10</b> 1000 lumens	30 3000 lumens	<b>LW6</b> Wallwash	<b>WR</b> <sup>2</sup> White	<b>LD</b> Matte diffuse		277 277V	
		50/ 5000K		15 1500 lumens	40 4000 lumens		<b>BR</b> <sup>2</sup> Black	<b>LS</b> Specular		347 <sup>3</sup> 347V	
				20 2000 lumens	50 5000 lumens						

Driver	Options
GZ10 0-10V driver dims to 10%	SF <sup>4</sup> Single fuse
GZ1 0-10V driver dims to 1%	TRW <sup>5</sup> White painted flange
EZ10 0-10V eldoLED driver with smooth and flicker-free deep dimming performance down to 10%	TRBL <sup>5</sup> Black painted flange
EZ1 0-10V eldoLED driver with smooth and flicker-free deep dimming performance down to 1%	EL <sup>6</sup> Emergency battery pack with integral test switch. 10W Constant Power, Not Certified in CA Title 20 MAEDBS
	ELR <sup>6</sup> Emergency battery pack with remote test switch. 10W Constant Power, Not Certified in CA Title 20 MAEDBS
	ELSD <sup>6</sup> Emergency battery pack with self-diagnostics, integral test switch. 10W Constant Power, Not Certified in CA Title 20 MAEDBS
	ELRSD <sup>6</sup> Emergency battery pack with self-diagnostics, remote test switch. 10W Constant Power, Not Certified in CA Title 20 MAEDBS
	E10WCP <sup>6</sup> Emergency battery pack, 10W Constant Power with integral test switch. Certified in CA Title 20 MAEDB
	E10WCPR <sup>6</sup> Emergency battery pack, 10W Constant Power with remote test switch. Certified in CA Title 20 MAEDB
	NPP16D <sup>7</sup> nLight® network power/relay pack with 0-10V dimming for non-eldoLED drivers (GZ10, GZ1).
	NPP16DER <sup>7</sup> nLight® network power/relay pack with 0-10V dimming for non-eldoLED drivers (GZ10, GZ1). ER controls fixtures on emergency circuit.
	N80 <sup>8</sup> nLight™ Lumen Compensation
	NPS80EZ <sup>7</sup> nLight® dimming pack controls 0-10V eldoLED drivers (EZ10, EZ1).
	NPS80EZER <sup>7</sup> nLight® dimming pack controls 0-10V eldoLED drivers (EZ10, EZ1). ER controls fixtures on emergency circuit.
	HAO <sup>11</sup> High ambient option
	CP <sup>12</sup> Chicago Plenum
	RRL___ RELOC®-ready luminaire connectors enable a simple and consistent factory installed option across all ABL luminaire brands. Refer to RRL for complete nomenclature. Available only in RRLA, RRLB, RRLAE, and RRLC12S.
	NLTAIR2 <sup>9,10</sup> nLight® Air enabled
	NLTAIRER2 <sup>9,10</sup> nLight® AIR Dimming Pack Wireless Controls. Controls fixtures on emergency circuit, not available with battery pack options
	USPOM US point of manufacture
	90CRI High CRI (90+)

Accessories: Order as separate catalog number.	
<a href="#">EAC ISSM 375</a>	Compact interruptible emergency AC power system
<a href="#">EAC ISSM 125</a>	Compact interruptible emergency AC power system
GRA68 JZ	Oversized trim ring with 8" outside diameter <sup>1</sup>
SCA6	Sloped ceiling adapter. Refer to <a href="#">TECH-SCA</a> for more options.

### Notes

- Overall height varies based on lumen package; refer to dimensional chart on page 3.
- Not available with finishes.
- Not available with emergency options.
- Must specify voltage 120V or 277V.
- Available with clear (AR) reflector only.
- 12.5" of plenum depth or top access required for battery pack maintenance.
- Specify voltage. ER for use with generator supply EM power. Will require an emergency hot feed and normal hot feed.
- Fixture begins at 80% light level. Must be specified with NPS80EZ or NPS80EZ ER. Only available with EZ10 and EZ1 drivers.
- Not available with CP, NPS80EZ, NPS80EZER, NPP16D, NPP16DER or N80 options.
- NLTAIR2 and NLTAIRER2 not recommended for metal ceiling installations.
- Fixture height is 6.5" for all lumen packages with HAO.
- Must specify voltage for 3000lm. 5000lm with marked spacing 24 L x 24 W x 14 H. Not available with emergency battery pack option.

# LDN6

## PHOTOMETRY

**Distribution Curve      Distribution Data      Output Data      Coefficient of Utilization      Illuminance Data at 30" Above Floor for a Single Luminaire**

**LDN6 35/10 L06AR**, input watts: 10.44, delivered lumens: 987.10, LM/W = 94.54, spacing criterion at 0= 1.02, test no. ISF 30716P262.

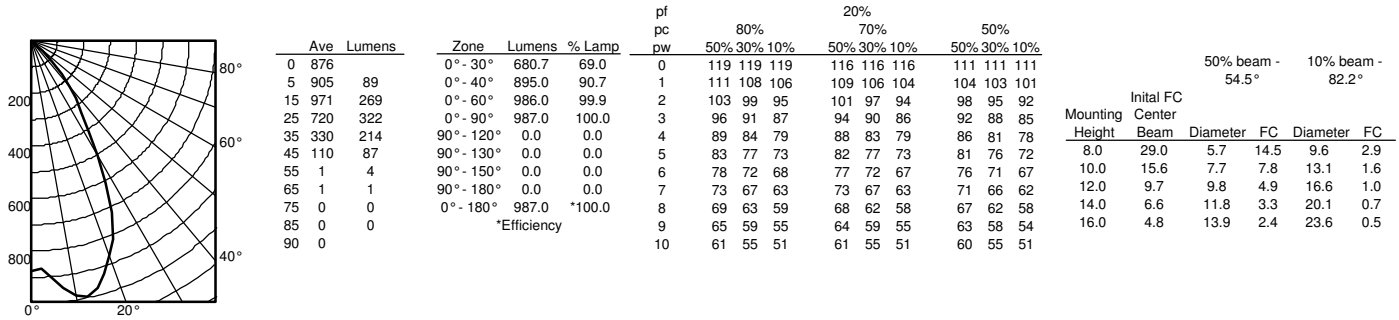

**LDN6 35/15 L06AR**, input watts: 17.52, delivered lumens: 1572.9, LM/W = 89.77, spacing criterion at 0= 1.02, test no. ISF 30716P265.

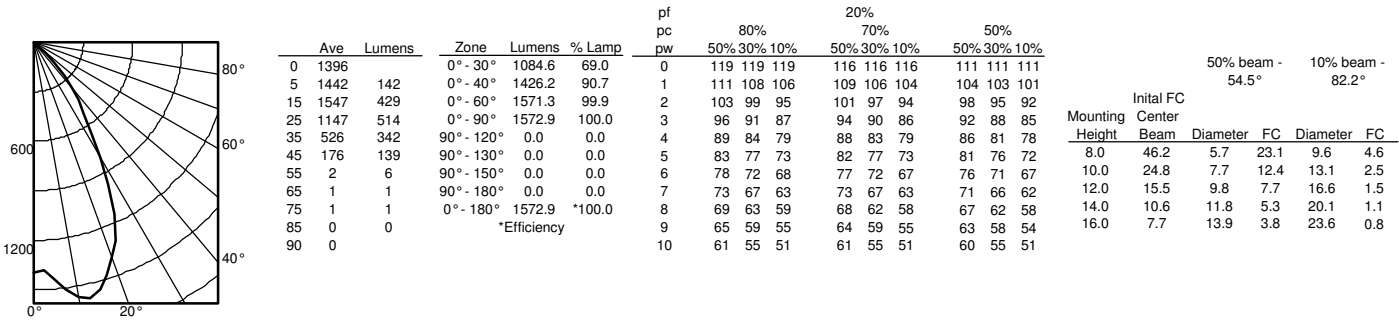

**LDN6 35/30 L06AR**, input watts: 34.75, delivered lumens: 3138.5, LM/W = 90.31, spacing criterion at 0= 1.02, test no. ISF 30716P274.

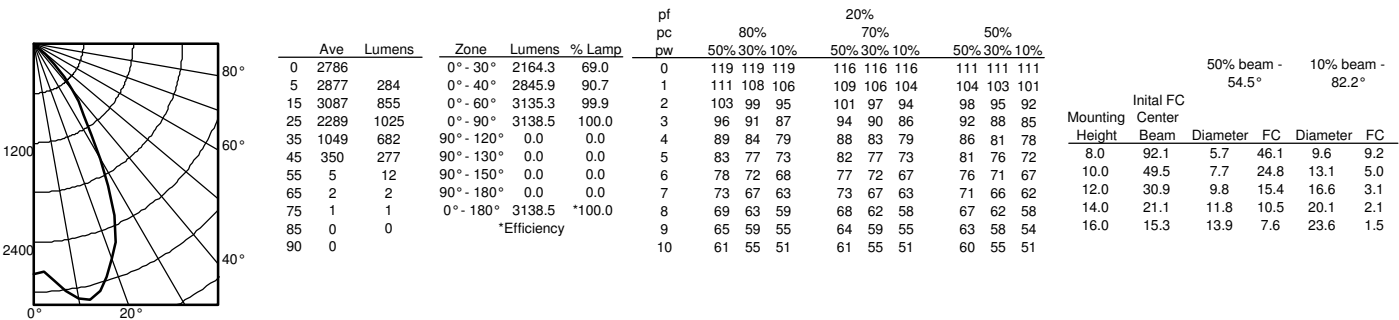



# LDN6

\* All dimensions are inches (centimeters) unless otherwise noted.

## LDN6 500-1500 LUMEN

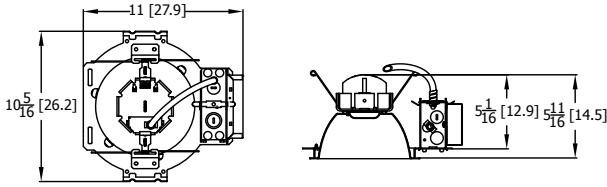

Aperture: 6-1/4 (15.9)  
Ceiling Opening: 7-1/8 (18.1)  
Overlap trim: 7-1/2 (19.1)

## LDN6 2000-3000 LUMEN

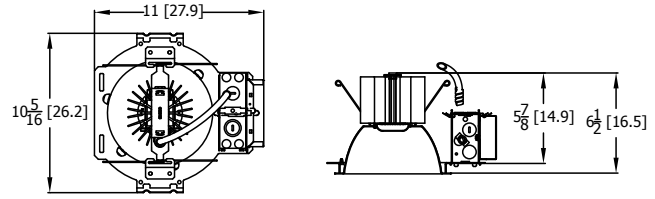

Aperture: 6-1/4 (15.9)  
Ceiling Opening: 7-1/8 (18.1)  
Overlap trim: 7-1/2 (19.1)

## LDN6 4000-5000 LUMEN

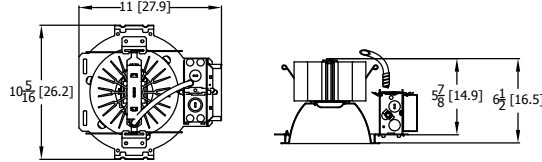

Marked Spacing: 24 x 24 x 10  
Aperture: 6-1/4 (15.9)  
Ceiling Opening: 7-1/8 (18.1)  
Overlap trim: 7-1/2 (19.1)

## LDN6 CP

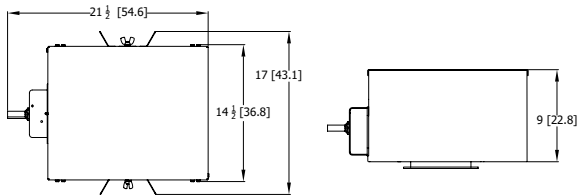

Aperture: 6-1/4" (15.9)  
Ceiling Opening: 7-1/8" (18.1)  
Overlap trim: 7-1/2" (19.1)

## LDN6 EL-ELR

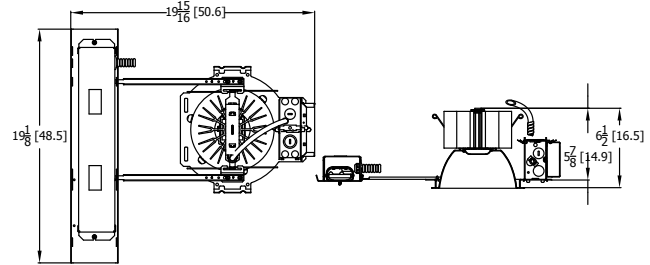

Marked Spacing above 3000 lumen: 24 x 24 x 10  
Aperture: 6-1/4 (15.9)  
Ceiling Opening: 7-1/8 (18.1)  
Overlap trim: 7-1/2 (19.1)

LDN6			
Nominal Lumens	Lumens	Wattage	Lm/W
500	527.9	5.8	90.5
750	758.1	8.9	85.1
1000	950.1	10.4	91.0
1500	1514	17.5	86.4
2000	2006	22.5	89.1
2500	2504	28.3	88.6
3000	3021	34.8	86.9
4000	4008	44.3	90.6
5000	4975	57.7	86.3

### HOW TO ESTIMATE DELIVERED LUMENS IN EMERGENCY MODE

Use the formula below to estimate the delivered lumens in emergency mode

$$\text{Delivered Lumens} = 1.25 \times P \times \text{LPW}$$

P = Output power of emergency driver. P = 10W for PS1055CP

LPW = Lumen per watt rating of the luminaire. This information is available on the ABL luminaire spec sheet.

The LPW rating is also available at [Designlight Consortium](http://Designlight Consortium).

	LUMEN OUTPUT MULTIPLIERS - FINISH		
	Clear (AR)	White (WR)	Black (BR)
Specular (LS)	1.0	N/A	N/A
Semi-specular (LSS)	0.950	N/A	N/A
Matte diffuse (LD)	0.85	N/A	N/A
Painted	N/A	0.87	0.73

	LUMEN OUTPUT MULTIPLIERS - CCT				
	2700K	3000K	3500K	4000K	5000K
80CRI	0.950	0.966	1.000	1.025	1.101

### Notes

- Tested in accordance with IESNA LM-79-08.
- Tested to current IES and NEMA standards under stabilized laboratory conditions.
- CRI: 80 typical.

## ADDITIONAL DATA

COMPATIBLE 0-10V WALL-MOUNT DIMMERS		
MANUFACTURER	PART NO.	POWER BOOSTER AVAILABLE
Lutron®	Diva® DDTV	
	Diva® DVSTV	
	Nova T® NTFTV	
	Nova® NFTV	
Leviton®	AWSMT-7DW	CN100
	AWSMG-7DW	PE300
	AMRMG-7DW	
	Leviton Centura Fluorescent Control System	
	IllumaTech® IP7 Series	
Synergy®	ISD BC	RDMFC
	SLD LPCS	
	Digital Equinox (DEQ BC)	
Douglas Lighting Controls	WPC-5721	
Entertainment Technology	Tap Glide TG600FAM120 (120V)	
	Tap Glide Heatsink TGH1500FAM120 (120V)	
	Oasis 0A2000FAMU	
Honeywell	EL7315A1019	EL7305A1010 (optional)
	EL7315A1009	
HUNT Dimming	Preset slide: PS-010-IV and PS-010-WH	
	Preset slide: PS-010-3W-IV and PS-010-3W-WH	
	Preset slide, controls FD-010: PS-IFC-010-IV and PS-IFC-010-WH-120/277V	
	Preset slide, controls FD-010: PS-IFC-010-3W-IV and PS-IFC-010-3W-WH-120/277V	
	Remote mounted unit: FD-010	
Lehigh Electronic Products	Solitaire	PBX
PDM Electrical Products	WPC-5721	
Starfield Controls	TR61 with DALI interface port	RT03 DALInet Router
WattStopper®	LS-4 used with LCD-101 and LCD-103	

### A+ Capable Luminaire

This item is an A+ capable luminaire, which has been designed and tested to provide consistent color appearance and out-of-the-box control compatibility with simple commissioning.

- All configurations of this luminaire meet the Acuity Brands' specification for chromatic consistency
- This luminaire is part of an A+ Certified solution for nLight® control networks when ordered with drivers marked by a **shaded background**\*
- This luminaire is part of an A+ Certified solution for nLight control networks, providing advanced control functionality at the luminaire level, when selection includes driver and control options marked by a **shaded background**\*

To learn more about A+, visit [www.acuitybrands.com/aplus](http://www.acuitybrands.com/aplus).

\*See ordering tree for details

# LDN6

## EXAMPLE

Group Fixture Control\*

\*Application diagram applies for fixtures with eldoLED drivers only.

- nPS 80 EZ** Dimming/Control Pack (qty: 2 required)
- nPODM 2P DX** Dual On/Off/Dim Push-Button WallPod
- nCM ADCX** Daylight Sensor with Automatic Dimming Control
- nCM PDT 9** Dual Technology Occupancy Sensor

**Description:** This design provides a dual on/off/dim wall station that enables manual control of the fixtures in Row A and Row B separately. Additionally, a daylight harvesting sensor is provided so the lights in Row B can be configured to dim automatically when daylight is available. An occupancy sensor turns off all lights when the space is vacant.

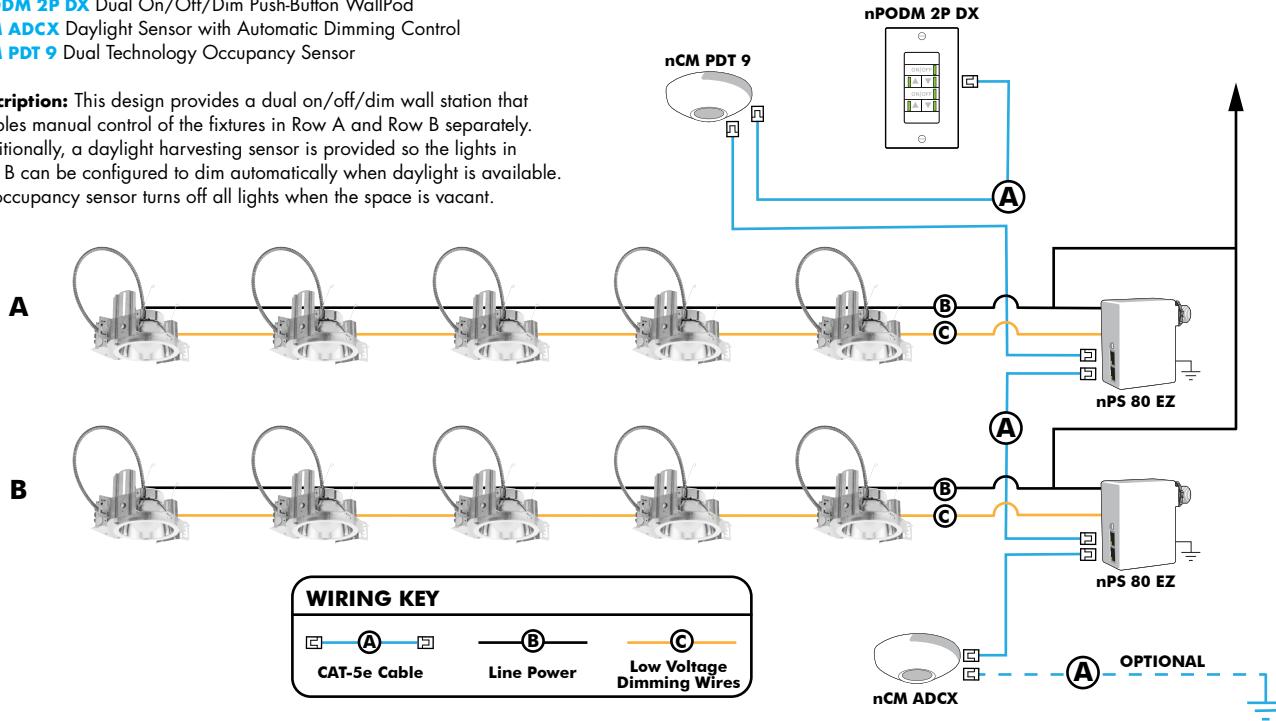

## Choose Wall Controls

nLight offers multiple styles of wall controls - each with varying features and user experience.



**Push-Button Wallpod**  
Traditional tactile buttons and LED user feedback



**Graphic Wallpod**  
Full color touch screen provides a sophisticated look and feel

## nLight® Wired Controls Accessories:

Order as separate catalog number. Visit [www.acuitybrands.com/products/controls/nlight](http://www.acuitybrands.com/products/controls/nlight) for complete listing of nLight controls.

WallPod Stations	Model number	Occupancy sensors	Model Number
On/Off	nPODM (Color)	Small motion 360°, ceiling (PIR/dual Tech)	nCM 9 / nCM PDT 9
On/Off & Raise/Lower	nPOD DX (Color)	Large motion 360°, ceiling (PIR/dual tech)	nCM 10 / nCM PDT 10
Graphic Touchscreen	nPOD GFX (Color)	Wide View (PIR/dual tech)	nWV 16 / nWV PDT 16
<b>Photocell controls</b>	<b>Model Number</b>	Wall Switch w/ Raise/Lower (PIR/dual tech)	nWSX LV DX / nWSX PDT LV DX
Dimming	nCM ADCX	<b>Cat-5 cables (plenum rated)</b>	<b>Model Number</b>
		10', CAT5 10FT	CATS 10FT J1
		15, CAT5 15FT	CATS 15FT J1

## nLight® AIR Control Accessories:

Order as separate catalog number. Visit [www.acuitybrands.com/products/controls/nlightair](http://www.acuitybrands.com/products/controls/nlightair).

Wall switches	Model number
On/Off single pole	rPODB [color]
On/Off two pole	rPODB 2P [color]
On/Off & raise/lower single pole	rPODB DX [color]
On/Off & raise/lower two pole	rPODB 2P DX [color]
On/Off & raise/lower single pole	rPODBZ DX WH <sup>1</sup>

## Notes

- 1 Can only be ordered with the RES7Z zone control sensor version.

## nLight AIR

nLight AIR is the ideal solution for retrofit or new construction spaces where adding communication is cost prohibitive. The integrated nLight AIR rPP20 Power Pack is part of each Lithonia LDN Luminaire. These individually addressable controls offer the ultimate in flexibility during initial setup and for space repurposing.



### Simple as 1,2,3

1. Install the nLight® AIR fixtures with embedded smart sensor
2. Install the wireless battery-powered wall switch
3. With CLAIRITY app, pair the fixtures with the wall switch and if desired, customize the sensor settings for the desired outcome





## FEATURES & SPECIFICATIONS

**INTENDED USE** — These specifications are for USA standards only. Check with factory for Canadian specifications. Square Straight Steel is a general purpose light pole for up to 39-foot mounting heights. This pole provides a robust yet cost effective option for mounting area lights and floodlights.

**CONSTRUCTION** — **Pole Shaft:** The pole shaft is of uniform dimension and wall thickness and is made of a weldable-grade, hot-rolled, commercial-quality steel tubing with a minimum yield of 55 KSI (11-gauge, .1196"), or 50 KSI (7-gauge, .1793"). Shaft is one-piece with a full-length longitudinal high-frequency electric resistance weld. Uniformly square in cross-section with flat sides, small corner radii and excellent torsional qualities. Available shaft widths are 4", 5" and 6".

**Pole Top:** A flush non-metallic black top cap is provided for all poles that will receive drilling patterns for side-mount luminaire arm assemblies or when ordered with PT option.

**Handhole:** A reinforced handhole with grounding provision is provided at 18" from the base on side A. Positioning the handhole lower may not be possible and requires engineering review; consult Tech Support-Outdoor for further information. Every handhole includes a cover and cover attachment hardware. The handhole has a nominal dimension of 2.5" x 5".

**Base Cover:** A durable ABS plastic two-piece full base cover, finished to match the pole, is provided with each pole assembly. Additional base cover options are available upon request.

**Anchor Base/ Bolts:** Anchor base is fabricated from steel that meets ASTM A36 standards and can be altered to match existing foundations; consult factory for modifications. Anchor bolts are manufactured to ASTM F1554 Standards grade 55, (55 KSI minimum yield strength and tensile strength of 75-95 KSI). Top threaded portion (nominal 12") is hot-dipped galvanized per ASTM A-153.

**HARDWARE** — All structural fasteners are high-strength galvanized carbon steel. All non-structural fasteners are galvanized or zinc-plated carbon steel or stainless steel.

**FINISH** — Extra durable standard powder-coat finishes include Dark Bronze, White, Black, Medium Bronze and Natural Aluminum colors. Classic finishes include Sandstone, Charcoal Gray, Tennis Green, Bright Red and Steel Blue colors. Architectural Colors and Special Finishes are available by quote and include, but are not limited to Hot-dipped Galvanized, Paint over Hot-dipped Galvanized, RAL Colors, Custom Colors and Extended Warranty Finishes. Factory-applied primer paint finish is available for customer field-paint applications.

**WARRANTY** — 1-year limited warranty. Complete warranty terms located at: [www.acuitybrands.com/CustomerResources/Terms\\_and\\_conditions.aspx](http://www.acuitybrands.com/CustomerResources/Terms_and_conditions.aspx)

**NOTE:** Actual performance may differ as a result of end-user environment and application. Specifications subject to change without notice.

Catalog Number
Notes
Type



20' POLE  
5" SQUARE

36" HIGH CONCRETE BASE  
24" DIAMETER

Anchor Base Poles

SSS

SQUARE STRAIGHT STEEL

# SSS Square Straight Steel Poles

## ORDERING INFORMATION

Lead times will vary depending on options selected. Consult with your sales representative.

**Example:** SSS 20 5C DM19 DDB

SSS	Nominal fixture mounting height	Nominal shaft base size/wall thickness <sup>1</sup>	Mounting <sup>2</sup>	Options	Finish <sup>10</sup>	
<b>SSS</b>	10'-39' (for 1/2 ft increments, add -6 to the pole height. Ex: 20-6 equals 20ft 6in.)  See technical information table for complete ordering information.)	4C 4" 11g (.1196") 4G 4" 7g (.1793") <b>5C</b> 5" 11g (.1196") 5G 5" 7g (.1793") 6G 6" 7g (.1793")  See technical information table for complete ordering information.)	<b>Tenon mounting</b> PT Open top (includes top cap) T20 2-3/8" O.D. (2" NPS) T25 2-7/8" O.D. (2-1/2" NPS) T30 3-1/2" O.D. (3" NPS) T35 4" O.D. (3-1/2" NPS) <b>KAC/KAD/KSE/KSF/KVR/KVE Drill mounting<sup>3</sup></b> DM19 1 at 90° DM28 2 at 180° DM28 PL 2 at 180° with one side plugged DM29 2 at 90° DM39 3 at 90° DM49 4 at 90° <b>CSX/DSX/RSX/AERIS™/OMERO™/HLA/KAX Drill mounting<sup>3</sup></b> <b>DM19AS</b> 1 at 90° DM28AS 2 at 180° DM29AS 2 at 90° DM39AS 3 at 90° DM49AS 4 at 90° <b>RAD drill mounting<sup>3</sup></b> DM19RAD 1 at 90° DM28RAD 2 at 180° DM29RAD 2 at 90° DM32RAD 3 at 120° DM39RAD 3 at 90° DM49RAD 4 at 90°	<b>AERIS™ Suspend drill mounting<sup>3,4</sup></b> DM19AST_ 1 at 90° DM28AST_ 2 at 180° DM29AST_ 2 at 90° DM39AST_ 3 at 90° DM49AST_ 4 at 90° <b>OMERO™ Suspend drill mounting<sup>3,4</sup></b> DM19MRT_ 1 at 90° DM28MRT_ 2 at 180° DM29MRT_ 2 at 90° DM39MRT_ 3 at 90° DM49MRT_ 4 at 90°	<b>Shipped installed</b> L/AB Less anchor bolts (Include when anchor bolts are not needed) VD Vibration damper TP Tamper resistant handhole cover fasteners HAxy Horizontal arm bracket (1 fixture) <sup>5,6</sup> FDLxy Festoon outlet less electrical <sup>5</sup> CPL12/xy 1/2" coupling <sup>5</sup> CPL34/xy 3/4" coupling <sup>5</sup> CPL1/xy 1" coupling <sup>5</sup> NPL12/xy 1/2" threaded nipple <sup>5</sup> NPL34/xy 3/4" threaded nipple <sup>5</sup> NPL1/xy 1" threaded nipple <sup>5</sup> EHHxy Extra handhole <sup>5,7</sup> MAEX Match existing <sup>8</sup> USPOM United States point of manufacture <sup>9</sup> <b>IC</b> Interior coating <sup>10</sup> UL UL listed with label (Includes NEC compliant cover) NEC NEC 410.30 compliant gasketed handhole (Not UL Labeled)  <b>Shipped separately (replacement kit available)</b> (blank) FBC Full base cover (plastic) (blank) TC Top cap (blank) HHC Handhole cover	<b>Standard colors</b> DDBXD Dark bronze DWHXD White DBLXD Black DMBXD Medium bronze DNAXD Natural aluminum  <b>Classic colors</b> DSS Sandstone DGC Charcoal gray DTG Tennis green DBR Bright red DSB Steel blue  <b>Architectural Colors and Special Finishes<sup>11</sup></b> Galvanized, Paint over Galvanized, RAL Colors, Custom Colors and Extended Warranty Finishes available.
	<b>20'</b>	<b>5"</b>				

### NOTES:

- Wall thickness will be signified with a "C" (11 Gauge) or a "G" (7-Gauge) in nomenclature. "C" - 0.1196" | "G" - 0.1793".
- PT open top poles include top cap. When ordering tenon mounting and drill mounting for the same pole, follow this example: DM28/T20. The combination includes a required extra handhole.
- Refer to the fixture spec sheet for the correct drilling template pattern and orientation compatibility.
- Insert "1" or "2" to designate fixture size; e.g. DM19AST2.

- Specify location and orientation when ordering option.  
For "x": Specify the height above the base of pole in feet or feet and inches; separate feet and inches with a "-".  
*Example: 5ft = 5 and 20ft 3in = 20-3*  
For "y": Specify orientation from handhole (A,B,C,D)  
*Refer to the Handhole Orientation diagram below.*  
*Example: 1/2" coupling at 5' 8", orientation C = CPL12/5-8C*
- Horizontal arm is 18" x 2-3/8" O.D. tenon standard, with radius curve providing 12" rise and 2-3/8" O.D. If ordering two horizontal arm at the same height, specify with HAxy. Example: HA20BD.

- Combination of tenon-top and drill mount includes extra handhole.
- Must add original order number of existing pole(s).
- Use when mill certifications are required.
- Provides enhanced corrosion resistance.
- Additional colors available; see [www.lithonia.com/archcolors](http://www.lithonia.com/archcolors) or Architectural Colors brochure (Form No. 794.3). Available by formal quote only, consult factory for details.

# SSS Square Straight Steel Poles

TECHNICAL INFORMATION — EPA (ft <sup>2</sup> ) with 1.3 gust													
Catalog Number	Nominal Shaft Length (ft.)*	Pole Shaft Size (Base in. x Top in. x ft.)	Wall thick (in)	Gauge	EPA (ft <sup>2</sup> ) with 1.3 gust						Bolt circle (in)	Bolt size (in. x in. x in.)	Approximate ship weight (lbs.)
					80 MPH	Max. weight	90 MPH	Max. weight	100 MPH	Max. weight			
SSS 10 4C	10	4.0 x 10.0	0.1196	11	30.6	765	23.8	595	18.9	473	8-9	3/4 x 18 x 3	75
SSS 12 4C	12	4.0 x 12.0	0.1196	11	24.4	610	18.8	470	14.8	370	8-9	3/4 x 18 x 3	90
SSS 14 4C	14	4.0 x 14.0	0.1196	11	19.9	498	15.1	378	11.7	293	8-9	3/4 x 18 x 3	100
SSS 16 4C	16	4.0 x 16.0	0.1196	11	15.9	398	11.8	295	8.9	223	8-9	3/4 x 18 x 3	115
SSS 18 4C	18	4.0 x 18.0	0.1196	11	12.6	315	9.2	230	6.7	168	8-9	3/4 x 18 x 3	125
SSS 20 4C	20	4.0 x 20.0	0.1196	11	9.6	240	6.7	167	4.5	150	8-9	3/4 x 18 x 3	140
SSS 20 4G	20	4.0 x 20.0	0.1793	7	14	350	11	275	8	200	8-9	3/4 x 30 x 3	198
SSS 20 5C	20	5.0 x 20.0	0.1196	11	17.7	443	12.7	343	9.4	235	10-12	1 x 36 x 4	185
SSS 20 5G	20	5.0 x 20.0	0.1793	7	28.1	703	21.4	535	16.2	405	10-12	1 x 36 x 4	265
SSS 25 4C	25	4.0 x 25.0	0.1196	11	4.8	150	2.6	100	1	50	8-9	3/4 x 18 x 3	170
SSS 25 4G	25	4.0 x 25.0	0.1793	7	10.8	270	7.7	188	5.4	135	8-9	3/4 x 30 x 3	245
SSS 25 5C	25	5.0 x 25.0	0.1196	11	9.8	245	6.3	157	3.7	150	10-12	1 x 36 x 4	225
SSS 25 5G	25	5.0 x 25.0	0.1793	7	18.5	463	13.3	333	9.5	238	10-12	1 x 36 x 4	360
SSS 30 4G	30	4.0 x 30.0	0.1793	7	6.7	168	4.4	110	2.6	65	8-9	3/4 x 30 x 3	295
SSS 30 5C	30	5.0 x 30.0	0.1196	11	4.7	150	2	50	--	--	10-12	1 x 36 x 4	265
SSS 30 5G	30	5.0 x 30.0	0.1793	7	10.7	267	6.7	167	3.9	100	10-12	1 x 36 x 4	380
SSS 30 6G	30	6.0 x 30.0	0.1793	7	19	475	13.2	330	9	225	11-13	1 x 36 x 4	520
SSS 35 5G	35	5.0 x 35.0	0.1793	7	5.9	150	2.5	100	--	--	10-12	1 x 36 x 4	440
SSS 35 6G	35	6.0 x 35.0	0.1793	7	12.4	310	7.6	190	4.2	105	11-13	1 x 36 x 4	540
SSS 39 6G	39	6.0 x 39.0	0.1793	7	7.2	180	3	75	--	--	11-13	1 x 36 x 4	605

\* EPA values are based ASCE 7-93 wind map. For 1/2 ft increments, add -6 to the pole height. Ex: 20-6 equals 20ft 6in.

## BASE DETAIL

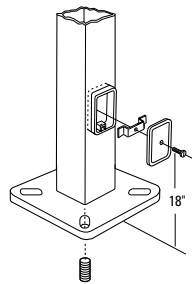

POLE DATA								
Shaft base size	Bolt circle A	Bolt projection B	Base diameter C	Base plate thickness	Template description	Anchor bolt description	Anchor bolt and template number	Anchor bolt description
4"C	8" - 9"	3.25" - 3.75"	8" - 8.25"	0.75"	ABTEMPLATE PJ50004	AB18-0	ABSSS-4C	3/4"x18"x3"
4"G	8" - 9"	3.38" - 3.75"	8" - 8.25"	0.875"	ABTEMPLATE PJ50004	AB30-0	ABSSS-4G	3/4"x30"x3"
5"	10" - 12"	3.5" - 4"	11"	1"	ABTEMPLATE PJ50010	AB36-0	ABSSS-5	1"x36"x4"
6"	11" - 13"	4" - 4.50"	12.5"	1"	ABTEMPLATE PJ50011	AB36-0	N/A	1"x36"x4"

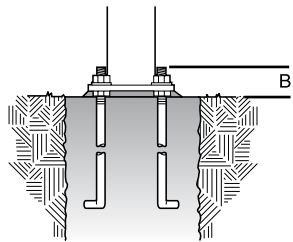
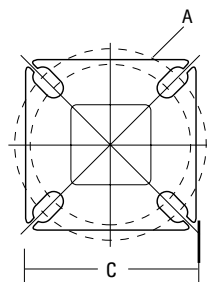

## HANDHOLE ORIENTATION

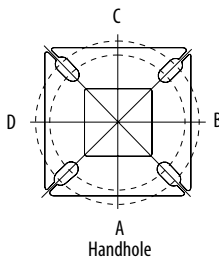

Default DM19 is on side B.

## IMPORTANT INSTALLATION NOTES:

- Do not erect poles without having fixtures installed.
- Factory-supplied templates must be used when setting anchor bolts. Lithonia Lighting will not accept claim for incorrect anchorage placement due to failure to use Lithonia Lighting factory templates.
- If poles are stored outside, all protective wrapping must be removed immediately upon delivery to prevent finish damage.
- Lithonia Lighting is not responsible for the foundation design.



## FEATURES & SPECIFICATIONS

**INTENDED USE** — These specifications are for USA standards only. Check with factory for Canadian specifications. Square Straight Steel is a general purpose light pole for up to 39-foot mounting heights. This pole provides a robust yet cost effective option for mounting area lights and floodlights.

**CONSTRUCTION** — **Pole Shaft:** The pole shaft is of uniform dimension and wall thickness and is made of a weldable-grade, hot-rolled, commercial-quality steel tubing with a minimum yield of 55 KSI (11-gauge, .1196"), or 50 KSI (7-gauge, .1793"). Shaft is one-piece with a full-length longitudinal high-frequency electric resistance weld. Uniformly square in cross-section with flat sides, small corner radii and excellent torsional qualities. Available shaft widths are 4", 5" and 6".

**Pole Top:** A flush non-metallic black top cap is provided for all poles that will receive drilling patterns for side-mount luminaire arm assemblies or when ordered with PT option.

**Handhole:** A reinforced handhole with grounding provision is provided at 18" from the base on side A. Positioning the handhole lower may not be possible and requires engineering review; consult Tech Support-Outdoor for further information. Every handhole includes a cover and cover attachment hardware. The handhole has a nominal dimension of 2.5" x 5".

**Base Cover:** A durable ABS plastic two-piece full base cover, finished to match the pole, is provided with each pole assembly. Additional base cover options are available upon request.

**Anchor Base/ Bolts:** Anchor base is fabricated from steel that meets ASTM A36 standards and can be altered to match existing foundations; consult factory for modifications. Anchor bolts are manufactured to ASTM F1554 Standards grade 55, (55 KSI minimum yield strength and tensile strength of 75-95 KSI). Top threaded portion (nominal 12") is hot-dipped galvanized per ASTM A-153.

**HARDWARE** — All structural fasteners are high-strength galvanized carbon steel. All non-structural fasteners are galvanized or zinc-plated carbon steel or stainless steel.

**FINISH** — Extra durable standard powder-coat finishes include Dark Bronze, White, Black, Medium Bronze and Natural Aluminum colors. Classic finishes include Sandstone, Charcoal Gray, Tennis Green, Bright Red and Steel Blue colors. Architectural Colors and Special Finishes are available by quote and include, but are not limited to Hot-dipped Galvanized, Paint over Hot-dipped Galvanized, RAL Colors, Custom Colors and Extended Warranty Finishes. Factory-applied primer paint finish is available for customer field-paint applications.

**WARRANTY** — 1-year limited warranty. Complete warranty terms located at: [www.acuitybrands.com/CustomerResources/Terms\\_and\\_conditions.aspx](http://www.acuitybrands.com/CustomerResources/Terms_and_conditions.aspx)

**NOTE:** Actual performance may differ as a result of end-user environment and application. Specifications subject to change without notice.

Catalog Number
Notes
Type



20' POLE  
5" SQUARE

36" HIGH CONCRETE BASE  
24" DIAMETER

Anchor Base Poles

SSS

SQUARE STRAIGHT STEEL



# SSS Square Straight Steel Poles

## ORDERING INFORMATION

Lead times will vary depending on options selected. Consult with your sales representative.

**Example:** SSS 20 5C DM19 DDB

SSS Series	Nominal fixture mounting height	Nominal shaft base size/wall thickness <sup>1</sup>	Mounting <sup>2</sup>	Options	Finish <sup>10</sup>	
<b>SSS</b>	10'-39' (for 1/2 ft increments, add -6 to the pole height. Ex: 20-6 equals 20ft 6in.)  See technical information table for complete ordering information.)	4C 4" 11g (.1196") 4G 4" 7g (.1793") <b>5C</b> 5" 11g (.1196") 5G 5" 7g (.1793") 6G 6" 7g (.1793")  See technical information table for complete ordering information.)	<b>Tenon mounting</b> PT Open top (includes top cap) T20 2-3/8" O.D. (2" NPS) T25 2-7/8" O.D. (2-1/2" NPS) T30 3-1/2" O.D. (3" NPS) T35 4" O.D. (3-1/2" NPS) <b>KAC/KAD/KSE/KSF/KVR/KVE Drill mounting<sup>3</sup></b> DM19 1 at 90° DM28 2 at 180° DM28 PL 2 at 180° with one side plugged DM29 2 at 90° DM39 3 at 90° DM49 4 at 90° <b>CSX/DSX/R SX/AERIS™/OMERO™/HLA/KAX Drill mounting<sup>3</sup></b> DM19AS 1 at 90° <b>DM28AS</b> 2 at 180° DM29AS 2 at 90° DM39AS 3 at 90° DM49AS 4 at 90° <b>RAD drill mounting<sup>3</sup></b> DM19RAD 1 at 90° DM28RAD 2 at 180° DM29RAD 2 at 90° DM32RAD 3 at 120° DM39RAD 3 at 90° DM49RAD 4 at 90°	<b>AERIS™ Suspend drill mounting<sup>3,4</sup></b> DM19AST_ 1 at 90° DM28AST_ 2 at 180° DM29AST_ 2 at 90° DM39AST_ 3 at 90° DM49AST_ 4 at 90° <b>OMERO™ Suspend drill mounting<sup>3,4</sup></b> DM19MRT_ 1 at 90° DM28MRT_ 2 at 180° DM29MRT_ 2 at 90° DM39MRT_ 3 at 90° DM49MRT_ 4 at 90°	<b>Shipped installed</b> L/AB Less anchor bolts (Include when anchor bolts are not needed) VD Vibration damper TP Tamper resistant handhole cover fasteners HAxy Horizontal arm bracket (1 fixture) <sup>5,6</sup> FDLxy Festoon outlet less electrical <sup>5</sup> CPL12/xy 1/2" coupling <sup>5</sup> CPL34/xy 3/4" coupling <sup>5</sup> CPL1/xy 1" coupling <sup>5</sup> NPL12/xy 1/2" threaded nipple <sup>5</sup> NPL34/xy 3/4" threaded nipple <sup>5</sup> NPL1/xy 1" threaded nipple <sup>5</sup> EHHxy Extra handhole <sup>5,7</sup> MAEX Match existing <sup>8</sup> USPOM United States point of manufacture <sup>9</sup> <b>IC</b> Interior coating <sup>10</sup> UL UL listed with label (Includes NEC compliant cover) NEC NEC 410.30 compliant gasketed handhole (Not UL Labeled)  <b>Shipped separately (replacement kit available)</b> (blank) FBC Full base cover (plastic) (blank) TC Top cap (blank) HHC Handhole cover	<b>Standard colors</b> DDBXD Dark bronze DWHXD White DBLXD Black DMBXD Medium bronze DNAXD Natural aluminum  <b>Classic colors</b> DSS Sandstone DGC Charcoal gray DTG Tennis green DBR Bright red DSB Steel blue  <b>Architectural Colors and Special Finishes<sup>11</sup></b> Galvanized, Paint over Galvanized, RAL Colors, Custom Colors and Extended Warranty Finishes available.
	<b>20'</b>	<b>5"</b>				

### NOTES:

1. Wall thickness will be signified with a "C" (11 Gauge) or a "G" (7-Gauge) in nomenclature. "C" - 0.1196" | "G" - 0.1793".
2. PT open top poles include top cap. When ordering tenon mounting and drill mounting for the same pole, follow this example: DM28/T20. The combination includes a required extra handhole.
3. Refer to the fixture spec sheet for the correct drilling template pattern and orientation compatibility.
4. Insert "1" or "2" to designate fixture size; e.g. DM19AST2.

5. Specify location and orientation when ordering option.  
For "x": Specify the height above the base of pole in feet or feet and inches; separate feet and inches with a "-".  
*Example: 5ft = 5 and 20ft 3in = 20-3*  
For "y": Specify orientation from handhole (A,B,C,D)  
*Refer to the Handhole Orientation diagram below.*  
*Example: 1/2" coupling at 5' 8", orientation C = CPL12/5-8C*
6. Horizontal arm is 18" x 2-3/8" O.D. tenon standard, with radius curve providing 12" rise and 2-3/8" O.D. If ordering two horizontal arm at the same height, specify with HAxy. Example: HA20BD.

7. Combination of tenon-top and drill mount includes extra handhole.
8. Must add original order number of existing pole(s).
9. Use when mill certifications are required.
10. Provides enhanced corrosion resistance.
11. Additional colors available; see [www.lithonia.com/archcolors](http://www.lithonia.com/archcolors) or Architectural Colors brochure (Form No. 794.3). Available by formal quote only, consult factory for details.

# SSS Square Straight Steel Poles

TECHNICAL INFORMATION — EPA (ft <sup>2</sup> ) with 1.3 gust													
Catalog Number	Nominal Shaft Length (ft.)*	Pole Shaft Size (Base in. x Top in. x ft.)	Wall thick (in)	Gauge	EPA (ft <sup>2</sup> ) with 1.3 gust						Bolt circle (in)	Bolt size (in. x in. x in.)	Approximate ship weight (lbs.)
					80 MPH	Max. weight	90 MPH	Max. weight	100 MPH	Max. weight			
SSS 10 4C	10	4.0 x 10.0	0.1196	11	30.6	765	23.8	595	18.9	473	8-9	3/4 x 18 x 3	75
SSS 12 4C	12	4.0 x 12.0	0.1196	11	24.4	610	18.8	470	14.8	370	8-9	3/4 x 18 x 3	90
SSS 14 4C	14	4.0 x 14.0	0.1196	11	19.9	498	15.1	378	11.7	293	8-9	3/4 x 18 x 3	100
SSS 16 4C	16	4.0 x 16.0	0.1196	11	15.9	398	11.8	295	8.9	223	8-9	3/4 x 18 x 3	115
SSS 18 4C	18	4.0 x 18.0	0.1196	11	12.6	315	9.2	230	6.7	168	8-9	3/4 x 18 x 3	125
SSS 20 4C	20	4.0 x 20.0	0.1196	11	9.6	240	6.7	167	4.5	150	8-9	3/4 x 18 x 3	140
SSS 20 4G	20	4.0 x 20.0	0.1793	7	14	350	11	275	8	200	8-9	3/4 x 30 x 3	198
SSS 20 5C	20	5.0 x 20.0	0.1196	11	17.7	443	12.7	343	9.4	235	10-12	1 x 36 x 4	185
SSS 20 5G	20	5.0 x 20.0	0.1793	7	28.1	703	21.4	535	16.2	405	10-12	1 x 36 x 4	265
SSS 25 4C	25	4.0 x 25.0	0.1196	11	4.8	150	2.6	100	1	50	8-9	3/4 x 18 x 3	170
SSS 25 4G	25	4.0 x 25.0	0.1793	7	10.8	270	7.7	188	5.4	135	8-9	3/4 x 30 x 3	245
SSS 25 5C	25	5.0 x 25.0	0.1196	11	9.8	245	6.3	157	3.7	150	10-12	1 x 36 x 4	225
SSS 25 5G	25	5.0 x 25.0	0.1793	7	18.5	463	13.3	333	9.5	238	10-12	1 x 36 x 4	360
SSS 30 4G	30	4.0 x 30.0	0.1793	7	6.7	168	4.4	110	2.6	65	8-9	3/4 x 30 x 3	295
SSS 30 5C	30	5.0 x 30.0	0.1196	11	4.7	150	2	50	--	--	10-12	1 x 36 x 4	265
SSS 30 5G	30	5.0 x 30.0	0.1793	7	10.7	267	6.7	167	3.9	100	10-12	1 x 36 x 4	380
SSS 30 6G	30	6.0 x 30.0	0.1793	7	19	475	13.2	330	9	225	11-13	1 x 36 x 4	520
SSS 35 5G	35	5.0 x 35.0	0.1793	7	5.9	150	2.5	100	--	--	10-12	1 x 36 x 4	440
SSS 35 6G	35	6.0 x 35.0	0.1793	7	12.4	310	7.6	190	4.2	105	11-13	1 x 36 x 4	540
SSS 39 6G	39	6.0 x 39.0	0.1793	7	7.2	180	3	75	--	--	11-13	1 x 36 x 4	605

\* EPA values are based ASCE 7-93 wind map. For 1/2 ft increments, add -6 to the pole height. Ex: 20-6 equals 20ft 6in.

## BASE DETAIL

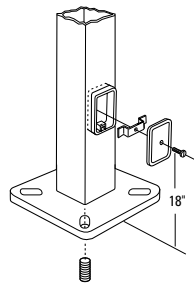

POLE DATA								
Shaft base size	Bolt circle A	Bolt projection B	Base diameter C	Base plate thickness	Template description	Anchor bolt description	Anchor bolt and template number	Anchor bolt description
4"C	8" - 9"	3.25" - 3.75"	8" - 8.25"	0.75"	ABTEMPLATE PJ50004	AB18-0	ABSSS-4C	3/4"x18"x3"
4"G	8" - 9"	3.38" - 3.75"	8" - 8.25"	0.875"	ABTEMPLATE PJ50004	AB30-0	ABSSS-4G	3/4"x30"x3"
5"	10" - 12"	3.5" - 4"	11"	1"	ABTEMPLATE PJ50010	AB36-0	ABSSS-5	1"x36"x4"
6"	11" - 13"	4" - 4.50"	12.5"	1"	ABTEMPLATE PJ50011	AB36-0	N/A	1"x36"x4"

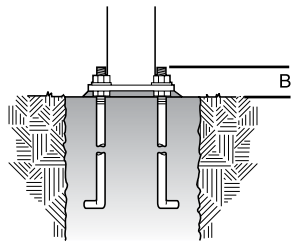
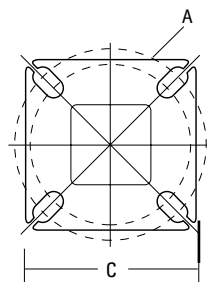

## HANDHOLE ORIENTATION

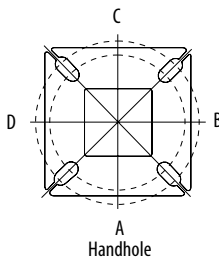

Default DM19 is on side B.

## IMPORTANT INSTALLATION NOTES:

- Do not erect poles without having fixtures installed.
- Factory-supplied templates must be used when setting anchor bolts. Lithonia Lighting will not accept claim for incorrect anchorage placement due to failure to use Lithonia Lighting factory templates.
- If poles are stored outside, all protective wrapping must be removed immediately upon delivery to prevent finish damage.
- Lithonia Lighting is not responsible for the foundation design.



# D-Series Size 1 LED Area Luminaire

d#series



Catalog Number
Notes
Type

Hit the Tab key or mouse over the page to see all interactive elements.

## Specifications

<b>EPA:</b>	1.01 ft <sup>2</sup> (0.09 m <sup>2</sup> )
<b>Length:</b>	33" (83.8 cm)
<b>Width:</b>	13" (33.0 cm)
<b>Height H1:</b>	7-1/2" (19.0 cm)
<b>Height H2:</b>	3-1/2"
<b>Weight (max):</b>	27 lbs (12.2 kg)

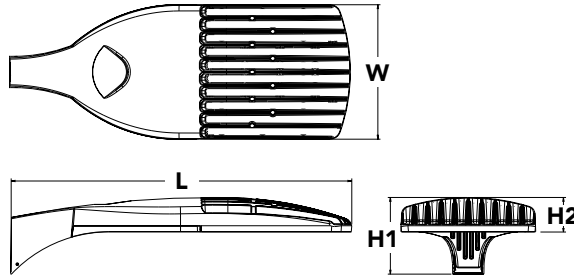

## Introduction

The modern styling of the D-Series is striking yet unobtrusive - making a bold, progressive statement even as it blends seamlessly with its environment. The D-Series distills the benefits of the latest in LED technology into a high performance, high efficacy, long-life luminaire.

The outstanding photometric performance results in sites with excellent uniformity, greater pole spacing and lower power density. It is ideal for replacing up to 750W metal halide in pedestrian and area lighting applications with typical energy savings of 65% and expected service life of over 100,000 hours.

A+ Capable options indicated by this color background.

## Ordering Information

**EXAMPLE:** DSX1 LED P7 40K T3M MVOLT SPA NLTAIR2 PIRHN DDBXD

DSX1 LED							
Series	LEDs	Color temperature		Distribution		Voltage	Mounting
<b>DSX1 LED</b>	<b>Forward optics</b> P1 <b>P4</b> P7 P2 P5 P8 P3 P6 P9 <b>Rotated optics</b> P10 <sup>1</sup> P12 <sup>1</sup> P11 <sup>1</sup> P13 <sup>1</sup>	30K 40K <b>50K</b>	3000 K 4000 K <b>5000 K</b>	T1S Type I short <b>T2M</b> Type II medium T3S Type III short T3M Type III medium T4M Type IV medium TFTM Forward throw medium	T5VS Type V very short T5S Type V short T5M Type V medium TSW Type V wide BLC Backlight control <sup>2</sup> LCCO Left corner cutoff <sup>2</sup> RCCO Right corner cutoff <sup>2</sup>	<b>MVOLT<sup>3</sup></b> 120 <sup>4</sup> 208 <sup>4</sup> 240 <sup>4</sup> 277 <sup>4</sup> 347 <sup>4,5</sup> 480 <sup>4,5</sup>	<b>Shipped included</b> <b>SPA</b> <b>Square pole mounting</b> RPA Round pole mounting WBA Wall bracket SPUMBA Square pole universal mounting adaptor <sup>6</sup> RPUMBA Round pole universal mounting adaptor <sup>6</sup> <b>Shipped separately</b> KMA8 DDBXD U Mast arm mounting bracket adaptor (specify finish) <sup>7</sup>

Control options	Other options	Finish (required)
<b>Shipped installed</b> NLTAIR2 nLight AIR generation 2 enabled <sup>8</sup> PIRHN Network, high/low motion/ambient sensor <sup>9</sup> PER NEMA twist-lock receptacle only (controls ordered separate) <sup>10</sup> PER5 Five-pin receptacle only (controls ordered separate) <sup>10,11</sup> PER7 Seven-pin receptacle only (controls ordered separate) <sup>10,11</sup> DMG 0-10v dimming wires pulled outside fixture (for use with an external control, ordered separately) <sup>12</sup> DS Dual switching <sup>12,13,14</sup>	PIR High/low, motion/ambient sensor, 8-15' mounting height, ambient sensor enabled at 5fc <sup>15,16</sup> PIRH High/low, motion/ambient sensor, 15-30' mounting height, ambient sensor enabled at 5fc <sup>15,16</sup> PIR1FC3V High/low, motion/ambient sensor, 8-15' mounting height, ambient sensor enabled at 1fc <sup>15,16</sup> PIRH1FC3V Bi-level, motion/ambient sensor, 15-30' mounting height, ambient sensor enabled at 1fc <sup>15,16</sup> FAO Field adjustable output <sup>14</sup>	<b>Shipped installed</b> HS House-side shield <sup>17</sup> SF Single fuse (120, 277, 347V) <sup>4</sup> DF Double fuse (208, 240, 480V) <sup>4</sup> L90 Left rotated optics <sup>1</sup> R90 Right rotated optics <sup>1</sup> <b>Shipped separately</b> BS Bird spikes <sup>18</sup> EGS External glare shield <sup>18</sup>
		DDBXD Dark bronze DBLXD Black DNAXD Natural aluminum DWHXD White DDBTXD Textured dark bronze DBLBXD Textured black DNATXD Textured natural aluminum DWHGXD Textured white



## Ordering Information

### Accessories

Ordered and shipped separately.

DLL127F 1.5 JU	Photocell - SSL twist-lock (120-277V) <sup>19</sup>
DLL347F 1.5 CUL JU	Photocell - SSL twist-lock (347V) <sup>19</sup>
DLL480F 1.5 CUL JU	Photocell - SSL twist-lock (480V) <sup>19</sup>
DSHORT SBK U	Shorting cap <sup>19</sup>
DSX1HS 30C U	House-side shield for P1, P2, P3, P4 and P5 <sup>17</sup>
DSX1HS 40C U	House-side shield for P6 and P7 <sup>17</sup>
DSX1HS 60C U	House-side shield for P8, P9, P10, P11 and P12 <sup>17</sup>
PUMBA DDBXD U*	Square and round pole universal mounting bracket (specify finish) <sup>20</sup>
KMA8 DDBXD U	Mast arm mounting bracket adaptor (specify finish) <sup>6</sup>

For more control options, visit [DTL](#) and [ROAM](#) online.

### NOTES

- P10, P11, P12 or P13 and rotated optics (L90, R90) only available together.
- Not available with HS.
- MVOLT driver operates on any line voltage from 120-277V (50/60 Hz).
- Single fuse (SF) requires 120V, 277V or 347V. Double fuse (DF) requires 208V, 240V or 480V.
- Not available in P1 or P10.
- Universal mounting brackets intended for retrofit on existing, pre-drilled poles only. 1.5 G vibration load rating per ANCI C136.31.
- Must order fixture with SPA option. Must be ordered as a separate accessory; see Accessories information. For use with 2-3/8" mast arm (not included).
- Must be ordered with PIRHN. Sensor cover available only in dark bronze, black, white and natural aluminum colors.
- Must be ordered with NLTAIR2. For more information on nLight Air 2 visit [this link](#).
- Photocell ordered and shipped as a separate line item from Acuity Brands Controls. See accessories. Not available with DS option. Shorting cap included.
- If ROAM<sup>®</sup> node required, it must be ordered and shipped as a separate line item from Acuity Brands Controls. Node with integral dimming.
- Provides 50/50 fixture operation via (2) independent drivers. Not available with PER, PER5, PER7, PIR or PIRH. Not available P1, P2, P3, P4 or P5.
- Requires (2) separately switched circuits with isolated neutral. See Outdoor Control Technical Guide for details.
- Reference Motion Sensor table on page 4.
- Reference controls options table on page 4 to see functionality.
- Not available with other dimming controls options
- Not available with BLC, LCCO and RCCO distribution. Also available as a separate accessory; see Accessories information.
- Must be ordered with fixture for factory pre-drilling.
- Requires luminaire to be specified with PER, PER5 or PER7 option. See PER Table on page 3.
- For retrofit use only.

## Options

### EGS - External Glare Shield

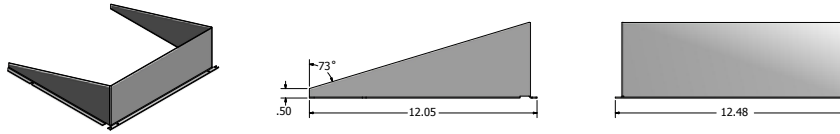

## Drilling

### HANDHOLE ORIENTATION

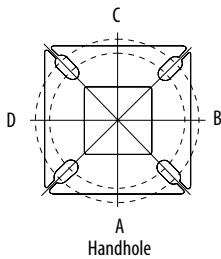

### Tenon Mounting Slipfitter\*\*

Tenon O.D.	Mounting	Single Unit	2 @ 180	2 @ 90	3 @ 120	3 @ 90	4 @ 90
2-3/8"	SPA/RPA	AS3-5 190	AS3-5 280	AS3-5 290	AS3-5 320	AS3-5 390	AS3-5 490
	SPUMBA	AS3-5 190	AS3-5 280	AS4-5 290	AS3-5 320	AS4-5 390	AS4-5 490
	RUPUMBA	AS3-5 190	AS3-5 280		AS3-5 320		
2-7/8"	SPA/RPA	AST25-190	AST25-280	AST25-290	AST25-320	AST25-390	AST25-490
	SPUMBA	AST25-190	AST25-280		AST25-320		
	RUPUMBA	AST25-190	AST25-280		AST25-320		
4"	SPA/RPA	AST35-190	AST35-280	AST35-290	AST35-320	AST35-390	AST35-490
	SPUMBA	AST35-190	AST35-280	AST35-290	AST35-320	AST35-390	AST35-490
	RUPUMBA	AST35-190	AST35-280		AST35-320		

Template #8

Top of Pole

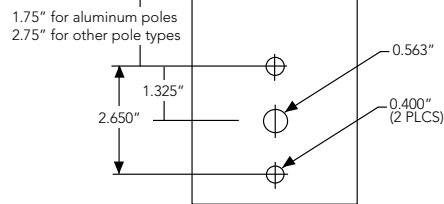

Mounting Option	Drilling Template	Single	2 @ 180	2 @ 90	3 @ 90	3 @ 120	4 @ 90
Head Location		Side B	Side B & D	Side B & C	Side B, C & D	Round Pole Only	Side A, B, C & D
Drill Nomenclature	#8	DM19AS	DM28AS	DM29AS	DM39AS	DM32AS	DM49AS

	Drilling Template	Minimum Acceptable Outside Pole Dimension					
SPA	#8	2-7/8"	2-7/8"	3.5"	3.5"	3"	3.5"
RPA	#8	2-7/8"	2-7/8"	3.5"	3.5"	3"	3.5"
SPUMBA	#5	2-7/8"	3"	4"	4"	3.5"	4"
RPUMBA	#5	2-7/8"	3.5"	5"	5"	3.5"	5"

# Photometric Diagrams

To see complete photometric reports or download .ies files for this product, visit Lithonia Lighting's [D-Series Area Size 1 homepage](#).

Isofootcandle plots for the DSX1 LED 60C 1000 40K. Distances are in units of mounting height (25').

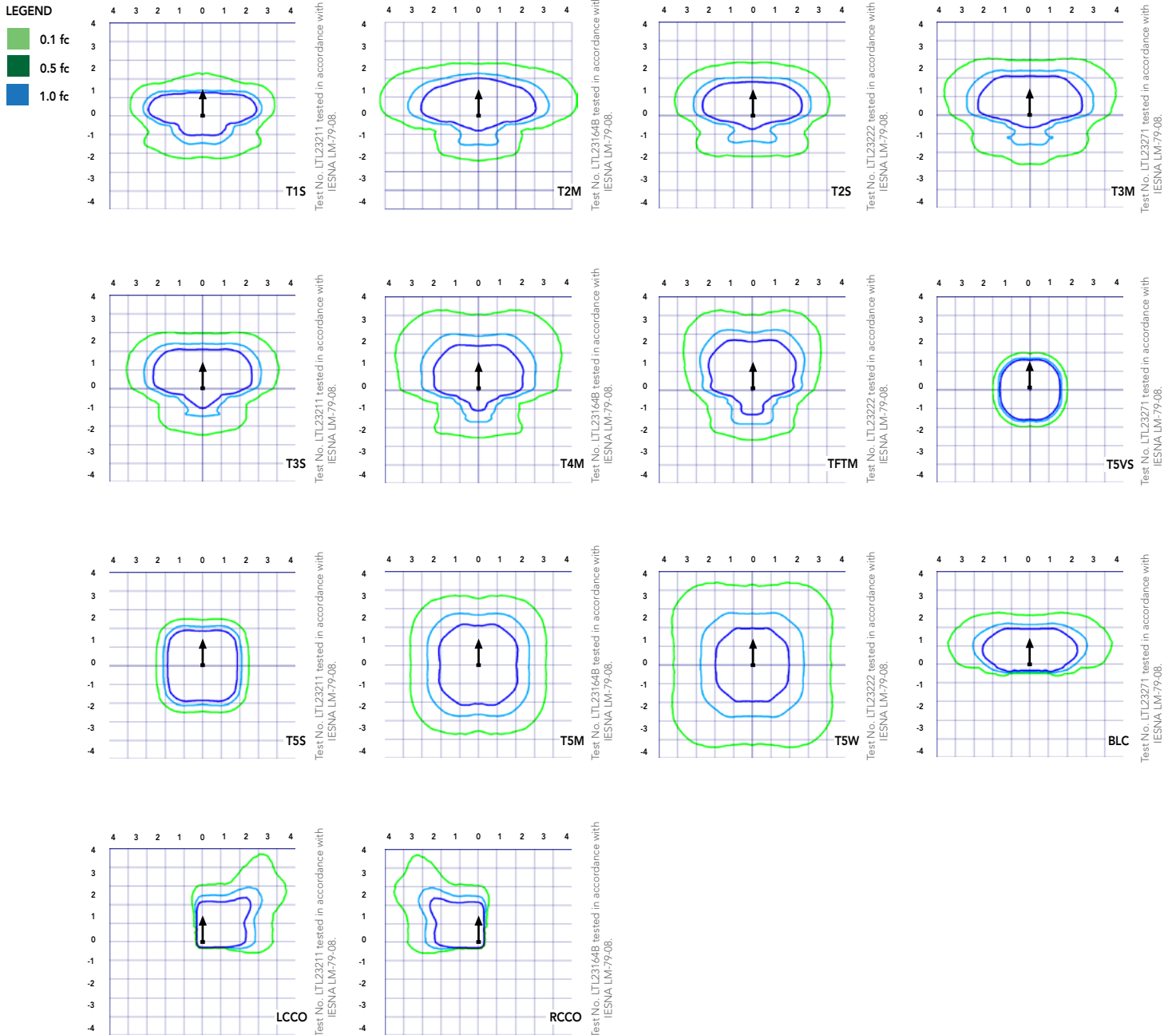

## Performance Data

### Lumen Ambient Temperature (LAT) Multipliers

Use these factors to determine relative lumen output for average ambient temperatures from 0-40°C (32-104°F).

Ambient		Lumen Multiplier
0°C	32°F	1.04
5°C	41°F	1.04
10°C	50°F	1.03
15°C	59°F	1.02
20°C	68°F	1.01
<b>25°C</b>	<b>77°F</b>	<b>1.00</b>
30°C	86°F	0.99
35°C	95°F	0.98
40°C	104°F	0.97

### Projected LED Lumen Maintenance

Data references the extrapolated performance projections for the platforms noted in a **25°C ambient**, based on 10,000 hours of LED testing (tested per IESNA LM-80-08 and projected per IESNA TM-21-11).

To calculate LLF, use the lumen maintenance factor that corresponds to the desired number of operating hours below. For other lumen maintenance values, contact factory.

Operating Hours	Lumen Maintenance Factor
0	1.00
25,000	0.96
50,000	0.92
100,000	0.85

#### Motion Sensor Default Settings

Option	Dimmed State	High Level (when triggered)	Photocell Operation	Dwell Time	Ramp-up Time	Ramp-down Time
PIR or PIRH	3V (37%) Output	10V (100%) Output	Enabled @ 5FC	5 min	3 sec	5 min
*PIR1FC3V or PIRH1FC3V	3V (37%) Output	10V (100%) Output	Enabled @ 1FC	5 min	3 sec	5 min

\*for use when motion sensor is used as dusk to dawn control.

### Electrical Load

	Performance Package	LED Count	Drive Current	Wattage	Current (A)					
					120	208	240	277	347	480
Forward Optics (Non-Rotated)	P1	30	530	54	0.45	0.26	0.23	0.19	0.10	0.12
	P2	30	700	70	0.59	0.34	0.30	0.25	0.20	0.16
	P3	30	1050	102	0.86	0.50	0.44	0.38	0.30	0.22
	P4	30	1250	125	1.06	0.60	0.52	0.46	0.37	0.27
	P5	30	1400	138	1.16	0.67	0.58	0.51	0.40	0.29
	P6	40	1250	163	1.36	0.78	0.68	0.59	0.47	0.34
	P7	40	1400	183	1.53	0.88	0.76	0.66	0.53	0.38
	P8	60	1050	207	1.74	0.98	0.87	0.76	0.64	0.49
	P9	60	1250	241	2.01	1.16	1.01	0.89	0.70	0.51
Rotated Optics (Requires L90 or R90)	P10	60	530	106	0.90	0.52	0.47	0.43	0.33	0.27
	P11	60	700	137	1.15	0.67	0.60	0.53	0.42	0.32
	P12	60	1050	207	1.74	0.99	0.87	0.76	0.60	0.46
	P13	60	1250	231	1.93	1.12	0.97	0.86	0.67	0.49

#### Controls Options

Nomenclature	Description	Functionality	Primary control device	Notes
FA0	Field adjustable output device installed inside the luminaire; wired to the driver dimming leads.	Allows the luminaire to be manually dimmed, effectively trimming the light output.	FA0 device	Cannot be used with other controls options that need the 0-10V leads
DS	Drivers wired independently for 50/50 luminaire operation	The luminaire is wired to two separate circuits, allowing for 50/50 operation.	Independently wired drivers	Requires two separately switched circuits. Consider nLight AIR as a more cost effective alternative.
PERS or PER7	Twist-lock photocell receptacle	Compatible with standard twist-lock photocells for dusk to dawn operation, or advanced control nodes that provide 0-10V dimming signals.	Twist-lock photocells such as DLL Elite or advanced control nodes such as ROAM.	Pins 4 & 5 to dimming leads on driver, Pins 6 & 7 are capped inside luminaire
PIR or PIRH	Motion sensors with integral photocell. PIR for 8-15' mounting; PIRH for 15-30' mounting	Luminaires dim when no occupancy is detected.	Acuity Controls SBOR	Also available with PIRH1FC3V when the sensor photocell is used for dusk-to-dawn operation.
NLTAIR2 PIRHN	nLight AIR enabled luminaire for motion sensing, photocell and wireless communication.	Motion and ambient light sensing with group response. Scheduled dimming with motion sensor over-ride when wirelessly connected to the nLight Eclipse.	nLight Air rSDGR	nLight AIR sensors can be programmed and commissioned from the ground using the CIAIRity Pro app.

Lumen Output

Lumen values are from photometric tests performed in accordance with IESNA LM-79-08. Data is considered to be representative of the configurations shown, within the tolerances allowed by Lighting Facts Contact factory for performance data on any configurations not shown here.

Forward Optics																			
LED Count	Drive Current	Power Package	System Watts	Dist. Type	30K (3000 K, 70 CRI)					40K (4000 K, 70 CRI)					50K (5000 K, 70 CRI)				
					Lumens	B	U	G	LPW	Lumens	B	U	G	LPW	Lumens	B	U	G	LPW
30	530	P1	54W	T1S	6,457	2	0	2	120	6,956	2	0	2	129	7,044	2	0	2	130
				T2S	6,450	2	0	2	119	6,949	2	0	2	129	7,037	2	0	2	130
				T2M	6,483	1	0	1	120	6,984	2	0	2	129	7,073	2	0	2	131
				T3S	6,279	2	0	2	116	6,764	2	0	2	125	6,850	2	0	2	127
				T3M	6,468	1	0	2	120	6,967	1	0	2	129	7,056	1	0	2	131
				T4M	6,327	1	0	2	117	6,816	1	0	2	126	6,902	1	0	2	128
				TFTM	6,464	1	0	2	120	6,963	1	0	2	129	7,051	1	0	2	131
				TSVS	6,722	2	0	0	124	7,242	3	0	0	134	7,334	3	0	0	136
				T5S	6,728	2	0	1	125	7,248	2	0	1	134	7,340	2	0	1	136
				T5M	6,711	3	0	1	124	7,229	3	0	1	134	7,321	3	0	2	136
				TSW	6,667	3	0	2	123	7,182	3	0	2	133	7,273	3	0	2	135
				BLC	5,299	1	0	1	98	5,709	1	0	2	106	5,781	1	0	2	107
				LCCO	3,943	1	0	2	73	4,248	1	0	2	79	4,302	1	0	2	80
				RCCO	3,943	1	0	2	73	4,248	1	0	2	79	4,302	1	0	2	80
				30	700	P2	70W	T1S	8,249	2	0	2	118	8,886	2	0	2	127	8,999
T2S	8,240	2	0					2	118	8,877	2	0	2	127	8,989	2	0	2	128
T2M	8,283	2	0					2	118	8,923	2	0	2	127	9,036	2	0	2	129
T3S	8,021	2	0					2	115	8,641	2	0	2	123	8,751	2	0	2	125
T3M	8,263	2	0					2	118	8,901	2	0	2	127	9,014	2	0	2	129
T4M	8,083	2	0					2	115	8,708	2	0	2	124	8,818	2	0	2	126
TFTM	8,257	2	0					2	118	8,896	2	0	2	127	9,008	2	0	2	129
TSVS	8,588	3	0					0	123	9,252	3	0	0	132	9,369	3	0	0	134
T5S	8,595	3	0					1	123	9,259	3	0	1	132	9,376	3	0	1	134
T5M	8,573	3	0					2	122	9,236	3	0	2	132	9,353	3	0	2	134
TSW	8,517	3	0					2	122	9,175	4	0	2	131	9,291	4	0	2	133
BLC	6,770	1	0					2	97	7,293	1	0	2	104	7,386	1	0	2	106
LCCO	5,038	1	0					2	72	5,427	1	0	2	78	5,496	1	0	2	79
RCCO	5,038	1	0					2	72	5,427	1	0	2	78	5,496	1	0	2	79
30	1050	P3	102W					T1S	11,661	2	0	2	114	12,562	3	0	3	123	12,721
				T2S	11,648	2	0	2	114	12,548	3	0	3	123	12,707	3	0	3	125
				T2M	11,708	2	0	2	115	12,613	2	0	2	124	12,773	2	0	2	125
				T3S	11,339	2	0	2	111	12,215	3	0	3	120	12,370	3	0	3	121
				T3M	11,680	2	0	2	115	12,582	2	0	2	123	12,742	2	0	2	125
				T4M	11,426	2	0	3	112	12,309	2	0	3	121	12,465	2	0	3	122
				TFTM	11,673	2	0	2	114	12,575	2	0	3	123	12,734	2	0	3	125
				TSVS	12,140	3	0	1	119	13,078	3	0	1	128	13,244	3	0	1	130
				T5S	12,150	3	0	1	119	13,089	3	0	1	128	13,254	3	0	1	130
				T5M	12,119	4	0	2	119	13,056	4	0	2	128	13,221	4	0	2	130
				TSW	12,040	4	0	3	118	12,970	4	0	3	127	13,134	4	0	3	129
				BLC	9,570	1	0	2	94	10,310	1	0	2	101	10,440	1	0	2	102
				LCCO	7,121	1	0	3	70	7,671	1	0	3	75	7,768	1	0	3	76
				RCCO	7,121	1	0	3	70	7,671	1	0	3	75	7,768	1	0	3	76
				30	1250	P4	125W	T1S	13,435	3	0	3	107	14,473	3	0	3	116	14,657
T2S	13,421	3	0					3	107	14,458	3	0	3	116	14,641	3	0	3	117
T2M	13,490	2	0					2	108	14,532	3	0	3	116	14,716	3	0	3	118
T3S	13,064	3	0					3	105	14,074	3	0	3	113	14,252	3	0	3	114
T3M	13,457	2	0					2	108	14,497	2	0	2	116	14,681	2	0	2	117
T4M	13,165	2	0					3	105	14,182	2	0	3	113	14,362	2	0	3	115
TFTM	13,449	2	0					3	108	14,488	2	0	3	116	14,672	2	0	3	117
TSVS	13,987	4	0					1	112	15,068	4	0	1	121	15,259	4	0	1	122
T5S	13,999	3	0					1	112	15,080	3	0	1	121	15,271	3	0	1	122
T5M	13,963	4	0					2	112	15,042	4	0	2	120	15,233	4	0	2	122
TSW	13,872	4	0					3	111	14,944	4	0	3	120	15,133	4	0	3	121
BLC	11,027	1	0					2	88	11,879	1	0	2	95	12,029	1	0	2	96
LCCO	8,205	1	0					3	66	8,839	1	0	3	71	8,951	1	0	3	72
RCCO	8,205	1	0					3	66	8,839	1	0	3	71	8,951	1	0	3	72
30	1400	P5	138W					T1S	14,679	3	0	3	106	15,814	3	0	3	115	16,014
				T2S	14,664	3	0	3	106	15,797	3	0	3	114	15,997	3	0	3	116
				T2M	14,739	3	0	3	107	15,878	3	0	3	115	16,079	3	0	3	117
				T3S	14,274	3	0	3	103	15,377	3	0	3	111	15,572	3	0	3	113
				T3M	14,704	2	0	3	107	15,840	3	0	3	115	16,040	3	0	3	116
				T4M	14,384	2	0	3	104	15,496	3	0	3	112	15,692	3	0	3	114
				TFTM	14,695	2	0	3	106	15,830	3	0	3	115	16,030	3	0	3	116
				TSVS	15,283	4	0	1	111	16,464	4	0	1	119	16,672	4	0	1	121
				T5S	15,295	3	0	1	111	16,477	4	0	1	119	16,686	4	0	1	121
				T5M	15,257	4	0	2	111	16,435	4	0	2	119	16,644	4	0	2	121
				TSW	15,157	4	0	3	110	16,328	4	0	3	118	16,534	4	0	3	120
				BLC	12,048	1	0	2	87	12,979	1	0	2	94	13,143	1	0	2	95
				LCCO	8,965	1	0	3	65	9,657	1	0	3	70	9,780	1	0	3	71
				RCCO	8,965	1	0	3	65	9,657	1	0	3	70	9,780	1	0	3	71





# Performance Data

## Lumen Output

Lumen values are from photometric tests performed in accordance with IESNA LM-79-08. Data is considered to be representative of the configurations shown, within the tolerances allowed by Lighting Facts. Contact factory for performance data on any configurations not shown here.

Forward Optics																			
LED Count	Drive Current	Power Package	System Watts	Dist. Type	30K (3000 K, 70 CRI)					40K (4000 K, 70 CRI)					50K (5000 K, 70 CRI)				
					Lumens	B	U	G	LPW	Lumens	B	U	G	LPW	Lumens	B	U	G	LPW
40	1250	P6	163W	T1S	17,654	3	0	3	108	19,018	3	0	3	117	19,259	3	0	3	118
				T2S	17,635	3	0	3	108	18,998	3	0	3	117	19,238	3	0	3	118
				T2M	17,726	3	0	3	109	19,096	3	0	3	117	19,337	3	0	3	119
				T3S	17,167	3	0	3	105	18,493	3	0	3	113	18,727	3	0	3	115
				T3M	17,683	3	0	3	108	19,049	3	0	3	117	19,290	3	0	3	118
				T4M	17,299	3	0	3	106	18,635	3	0	4	114	18,871	3	0	4	116
				TFTM	17,672	3	0	3	108	19,038	3	0	4	117	19,279	3	0	4	118
				TSVS	18,379	4	0	1	113	19,800	4	0	1	121	20,050	4	0	1	123
				T5S	18,394	4	0	2	113	19,816	4	0	2	122	20,066	4	0	2	123
				T5M	18,348	4	0	2	113	19,766	4	0	2	121	20,016	4	0	2	123
				TSW	18,228	5	0	3	112	19,636	5	0	3	120	19,885	5	0	3	122
				BLC	14,489	2	0	2	89	15,609	2	0	3	96	15,806	2	0	3	97
				LCCO	10,781	1	0	3	66	11,614	1	0	3	71	11,761	2	0	3	72
				RCCO	10,781	1	0	3	66	11,614	1	0	3	71	11,761	2	0	3	72
40	1400	P7	183W	T1S	19,227	3	0	3	105	20,712	3	0	3	113	20,975	3	0	3	115
				T2S	19,206	3	0	3	105	20,690	3	0	3	113	20,952	3	0	3	114
				T2M	19,305	3	0	3	105	20,797	3	0	3	114	21,060	3	0	3	115
				T3S	18,696	3	0	3	102	20,141	3	0	3	110	20,396	3	0	4	111
				T3M	19,258	3	0	3	105	20,746	3	0	3	113	21,009	3	0	3	115
				T4M	18,840	3	0	4	103	20,296	3	0	4	111	20,553	3	0	4	112
				TFTM	19,246	3	0	4	105	20,734	3	0	4	113	20,996	3	0	4	115
				TSVS	20,017	4	0	1	109	21,564	4	0	1	118	21,837	4	0	1	119
				T5S	20,033	4	0	2	109	21,581	4	0	2	118	21,854	4	0	2	119
				T5M	19,983	4	0	2	109	21,527	5	0	3	118	21,799	5	0	3	119
				TSW	19,852	5	0	3	108	21,386	5	0	3	117	21,656	5	0	3	118
				BLC	15,780	2	0	3	86	16,999	2	0	3	93	17,214	2	0	3	94
				LCCO	11,742	2	0	3	64	12,649	2	0	3	69	12,809	2	0	3	70
				RCCO	11,742	2	0	3	64	12,649	2	0	3	69	12,809	2	0	3	70
60	1050	P8	207W	T1S	22,490	3	0	3	109	24,228	3	0	3	117	24,535	3	0	3	119
				T2S	22,466	3	0	4	109	24,202	3	0	4	117	24,509	3	0	4	118
				T2M	22,582	3	0	3	109	24,327	3	0	3	118	24,635	3	0	3	119
				T3S	21,870	3	0	4	106	23,560	3	0	4	114	23,858	3	0	4	115
				T3M	22,527	3	0	4	109	24,268	3	0	4	117	24,575	3	0	4	119
				T4M	22,038	3	0	4	106	23,741	3	0	4	115	24,041	3	0	4	116
				TFTM	22,513	3	0	4	109	24,253	3	0	4	117	24,560	3	0	4	119
				TSVS	23,415	5	0	1	113	25,224	5	0	1	122	25,543	5	0	1	123
				T5S	23,434	4	0	2	113	25,244	4	0	2	122	25,564	4	0	2	123
				T5M	23,374	5	0	3	113	25,181	5	0	3	122	25,499	5	0	3	123
				TSW	23,221	5	0	4	112	25,016	5	0	4	121	25,332	5	0	4	122
				BLC	18,458	2	0	3	89	19,885	2	0	3	96	20,136	2	0	3	97
				LCCO	13,735	2	0	3	66	14,796	2	0	4	71	14,983	2	0	4	72
				RCCO	13,735	2	0	3	66	14,796	2	0	4	71	14,983	2	0	4	72
60	1250	P9	241W	T1S	25,575	3	0	3	106	27,551	3	0	3	114	27,900	3	0	3	116
				T2S	25,548	3	0	4	106	27,522	3	0	4	114	27,871	3	0	4	116
				T2M	25,680	3	0	3	107	27,664	3	0	3	115	28,014	3	0	3	116
				T3S	24,870	3	0	4	103	26,791	3	0	4	111	27,130	3	0	4	113
				T3M	25,617	3	0	4	106	27,597	3	0	4	115	27,946	3	0	4	116
				T4M	25,061	3	0	4	104	26,997	3	0	4	112	27,339	3	0	4	113
				TFTM	25,602	3	0	4	106	27,580	3	0	4	114	27,929	3	0	4	116
				TSVS	26,626	5	0	1	110	28,684	5	0	1	119	29,047	5	0	1	121
				T5S	26,648	4	0	2	111	28,707	5	0	2	119	29,070	5	0	2	121
				T5M	26,581	5	0	3	110	28,635	5	0	3	119	28,997	5	0	3	120
				TSW	26,406	5	0	4	110	28,447	5	0	4	118	28,807	5	0	4	120
				BLC	20,990	2	0	3	87	22,612	2	0	3	94	22,898	2	0	3	95
				LCCO	15,619	2	0	4	65	16,825	2	0	4	70	17,038	2	0	4	71
				RCCO	15,619	2	0	4	65	16,825	2	0	4	70	17,038	2	0	4	71

# Performance Data

## Lumen Output

Lumen values are from photometric tests performed in accordance with IESNA LM-79-08. Data is considered to be representative of the configurations shown, within the tolerances allowed by Lighting Facts. Contact factory for performance data on any configurations not shown here.

Rotated Optics																			
LED Count	Drive Current	Power Package	System Watts	Dist. Type	30K (3000 K, 70 CRI)					40K (4000 K, 70 CRI)					50K (5000 K, 70 CRI)				
					Lumens	B	U	G	LPW	Lumens	B	U	G	LPW	Lumens	B	U	G	LPW
60	530	P10	106W	T1S	13,042	3	0	3	123	14,050	3	0	3	133	14,228	3	0	3	134
				T2S	12,967	4	0	4	122	13,969	4	0	4	132	14,146	4	0	4	133
				T2M	13,201	3	0	3	125	14,221	3	0	3	134	14,401	3	0	3	136
				T3S	12,766	4	0	4	120	13,752	4	0	4	130	13,926	4	0	4	131
				T3M	13,193	4	0	4	124	14,213	4	0	4	134	14,393	4	0	4	136
				T4M	12,944	4	0	4	122	13,945	4	0	4	132	14,121	4	0	4	133
				TFTM	13,279	4	0	4	125	14,305	4	0	4	135	14,486	4	0	4	137
				TSVS	13,372	3	0	1	126	14,405	4	0	1	136	14,588	4	0	1	138
				T5S	13,260	3	0	1	125	14,284	3	0	1	135	14,465	3	0	1	136
				T5M	13,256	4	0	2	125	14,281	4	0	2	135	14,462	4	0	2	136
				TSW	13,137	4	0	3	124	14,153	4	0	3	134	14,332	4	0	3	135
				BLC	10,906	3	0	3	103	11,749	3	0	3	111	11,898	3	0	3	112
				LCCO	7,789	1	0	3	73	8,391	1	0	3	79	8,497	1	0	3	80
				RCCO	7,779	4	0	4	73	8,380	4	0	4	79	8,486	4	0	4	80
60	700	P11	137W	T1S	16,556	3	0	3	121	17,835	3	0	3	130	18,061	4	0	4	132
				T2S	16,461	4	0	4	120	17,733	4	0	4	129	17,957	4	0	4	131
				T2M	16,758	4	0	4	122	18,053	4	0	4	132	18,281	4	0	4	133
				T3S	16,205	4	0	4	118	17,457	4	0	4	127	17,678	4	0	4	129
				T3M	16,748	4	0	4	122	18,042	4	0	4	132	18,271	4	0	4	133
				T4M	16,432	4	0	4	120	17,702	4	0	4	129	17,926	4	0	4	131
				TFTM	16,857	4	0	4	123	18,159	4	0	4	133	18,389	4	0	4	134
				TSVS	16,975	4	0	1	124	18,287	4	0	1	133	18,518	4	0	1	135
				T5S	16,832	4	0	1	123	18,133	4	0	2	132	18,362	4	0	2	134
				T5M	16,828	4	0	2	123	18,128	4	0	2	132	18,358	4	0	2	134
				TSW	16,677	4	0	3	122	17,966	5	0	3	131	18,193	5	0	3	133
				BLC	13,845	3	0	3	101	14,915	3	0	3	109	15,103	3	0	3	110
				LCCO	9,888	1	0	3	72	10,652	2	0	3	78	10,787	2	0	3	79
				RCCO	9,875	4	0	4	72	10,638	4	0	4	78	10,773	4	0	4	79
60	1050	P12	207W	T1S	22,996	4	0	4	111	24,773	4	0	4	120	25,087	4	0	4	121
				T2S	22,864	4	0	4	110	24,631	5	0	5	119	24,943	5	0	5	120
				T2M	23,277	4	0	4	112	25,075	4	0	4	121	25,393	4	0	4	123
				T3S	22,509	4	0	4	109	24,248	5	0	5	117	24,555	5	0	5	119
				T3M	23,263	4	0	4	112	25,061	4	0	4	121	25,378	4	0	4	123
				T4M	22,824	5	0	5	110	24,588	5	0	5	119	24,899	5	0	5	120
				TFTM	23,414	5	0	5	113	25,223	5	0	5	122	25,543	5	0	5	123
				TSVS	23,579	5	0	1	114	25,401	5	0	1	123	25,722	5	0	1	124
				T5S	23,380	4	0	2	113	25,187	4	0	2	122	25,506	4	0	2	123
				T5M	23,374	5	0	3	113	25,181	5	0	3	122	25,499	5	0	3	123
				TSW	23,165	5	0	4	112	24,955	5	0	4	121	25,271	5	0	4	122
				BLC	19,231	4	0	4	93	20,717	4	0	4	100	20,979	4	0	4	101
				LCCO	13,734	2	0	3	66	14,796	2	0	4	71	14,983	2	0	4	72
				RCCO	13,716	4	0	4	66	14,776	4	0	4	71	14,963	4	0	4	72
60	1250	P13	231W	T1S	25,400	4	0	4	110	27,363	4	0	4	118	27,709	4	0	4	120
				T2S	25,254	5	0	5	109	27,205	5	0	5	118	27,550	5	0	5	119
				T2M	25,710	4	0	4	111	27,696	4	0	4	120	28,047	4	0	4	121
				T3S	24,862	5	0	5	108	26,783	5	0	5	116	27,122	5	0	5	117
				T3M	25,695	5	0	5	111	27,680	5	0	5	120	28,031	5	0	5	121
				T4M	25,210	5	0	5	109	27,158	5	0	5	118	27,502	5	0	5	119
				TFTM	25,861	5	0	5	112	27,860	5	0	5	121	28,212	5	0	5	122
				TSVS	26,043	5	0	1	113	28,056	5	0	1	121	28,411	5	0	1	123
				T5S	25,824	4	0	2	112	27,819	5	0	2	120	28,172	5	0	2	122
				T5M	25,818	5	0	3	112	27,813	5	0	3	120	28,165	5	0	3	122
				TSW	25,586	5	0	4	111	27,563	5	0	4	119	27,912	5	0	4	121
				BLC	21,241	4	0	4	92	22,882	4	0	4	99	23,172	4	0	4	100
				LCCO	15,170	2	0	4	66	16,342	2	0	4	71	16,549	2	0	4	72
				RCCO	15,150	5	0	5	66	16,321	5	0	5	71	16,527	5	0	5	72

## A+ Capable Luminaire

This item is an A+ capable luminaire, which has been designed and tested to provide consistent color appearance and system-level interoperability.

- All configurations of this luminaire meet the Acuity Brands' specification for chromatic consistency
- This luminaire is A+ Certified when ordered with DTL® controls marked by a shaded background. DTL DLL equipped luminaires meet the A+ specification for luminaire to photocontrol interoperability<sup>1</sup>
- This luminaire is part of an A+ Certified solution for ROAM® or XPoint™ Wireless control networks, providing out-of-the-box control compatibility with simple commissioning, when ordered with drivers and control options marked by a shaded background<sup>1</sup>

To learn more about A+, visit [www.acuitybrands.com/aplus](http://www.acuitybrands.com/aplus).

1. See ordering tree for details.
2. A+ Certified Solutions for ROAM require the order of one ROAM node per luminaire. Sold Separately: [Link to Roam](#); [Link to DTL DLL](#)

## FEATURES & SPECIFICATIONS

### INTENDED USE

The sleek design of the D-Series Size 1 reflects the embedded high performance LED technology. It is ideal for many commercial and municipal applications, such as parking lots, plazas, campuses, and streetscapes.

### CONSTRUCTION

Single-piece die-cast aluminum housing has integral heat sink fins to optimize thermal management through conductive and convective cooling. Modular design allows for ease of maintenance and future light engine upgrades. The LED drivers are mounted in direct contact with the casting to promote low operating temperature and long life. Housing is completely sealed against moisture and environmental contaminants (IP65). Low EPA (1.01 ft<sup>2</sup>) for optimized pole wind loading.

### FINISH

Exterior parts are protected by a zinc-infused Super Durable TGIC thermoset powder coat finish that provides superior resistance to corrosion and weathering. A tightly controlled multi-stage process ensures a minimum 3 mils thickness for a finish that can withstand extreme climate changes without cracking or peeling. Available in both textured and non-textured finishes.

### OPTICS

Precision-molded proprietary acrylic lenses are engineered for superior area lighting distribution, uniformity, and pole spacing. Light engines are available in standard 3000 K, 4000 K and 5000 K (70 CRI) configurations. The D-Series Size 1 has zero uplight and qualifies as a Nighttime Friendly™ product, meaning it is consistent with the LEED® and Green Globes™ criteria for eliminating wasteful uplight.

### ELECTRICAL

Light engine configurations consist of high-efficacy LEDs mounted to metal-core circuit boards to maximize heat dissipation and promote long life (up to L85/100,000 hours at 25°C). Class 1 electronic drivers are designed to have a power factor >90%, THD <20%, and an expected life of 100,000 hours with <1% failure rate. Easily serviceable 10kV surge protection device meets a minimum Category C Low operation (per ANSI/IEEE C62.41.2).

### STANDARD CONTROLS

The DSX1 LED area luminaire has a number of control options. Dusk to dawn controls can be utilized via optional NEMA twist-lock photocell receptacles. Integrated motion sensors with on-board photocells feature field-adjustable programming and are suitable for mounting heights up to 30 feet.

### nLIGHT AIR CONTROLS

The DSX1 LED area luminaire is also available with nLight® AIR for the ultimate in wireless control. This powerful controls platform provides out-of-the-box basic motion sensing and photocontrol functionality and is suitable for mounting heights up to 40 feet. Once commissioned using a smartphone and the easy-to-use CLAIRITY app, nLight AIR equipped luminaires can be grouped, resulting in motion sensor and photocell group response without the need for additional equipment. Scheduled dimming with motion sensor over-ride can be achieved when used with the nLight Eclipse. Additional information about nLight Air can be found here.

### INSTALLATION

Included mounting block and integral arm facilitate quick and easy installation. Stainless steel bolts fasten the mounting block securely to poles and walls, enabling the D-Series Size 1 to withstand up to a 3.0 G vibration load rating per ANSI C136.31. The D-Series Size 1 utilizes the AERIS™ series pole drilling pattern (template #8). NEMA photocontrol receptacle are also available.

### LISTINGS

UL Listed for wet locations. Light engines are IP66 rated; luminaire is IP65 rated. Rated for -40°C minimum ambient. U.S. Patent No. D672,492 S. International patent pending.

DesignLights Consortium® (DLC) Premium qualified product and DLC qualified product.

Not all versions of this product may be DLC Premium qualified or DLC qualified. Please check the DLC Qualified Products List at [www.designlights.org/QPL](http://www.designlights.org/QPL) to confirm which versions are qualified.

International Dark-Sky Association (IDA) Fixture Seal of Approval (FSA) is available for all products on this page utilizing 3000K color temperature only.

### WARRANTY

5-year limited warranty. Complete warranty terms located at: [www.acuitybrands.com/CustomerResources/Terms\\_and\\_conditions.aspx](http://www.acuitybrands.com/CustomerResources/Terms_and_conditions.aspx)

**Note:** Actual performance may differ as a result of end-user environment and application.

All values are design or typical values, measured under laboratory conditions at 25 °C.

Specifications subject to change without notice.





# D-Series Size 1 LED Area Luminaire

d#series



Catalog Number
Notes
Type

Hit the Tab key or mouse over the page to see all interactive elements.

## Specifications

<b>EPA:</b>	1.01 ft <sup>2</sup> (0.09 m <sup>2</sup> )
<b>Length:</b>	33" (83.8 cm)
<b>Width:</b>	13" (33.0 cm)
<b>Height H1:</b>	7-1/2" (19.0 cm)
<b>Height H2:</b>	3-1/2"
<b>Weight (max):</b>	27 lbs (12.2 kg)

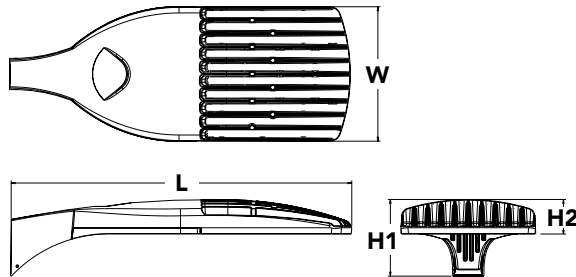

## Introduction

The modern styling of the D-Series is striking yet unobtrusive - making a bold, progressive statement even as it blends seamlessly with its environment. The D-Series distills the benefits of the latest in LED technology into a high performance, high efficacy, long-life luminaire.

The outstanding photometric performance results in sites with excellent uniformity, greater pole spacing and lower power density. It is ideal for replacing up to 750W metal halide in pedestrian and area lighting applications with typical energy savings of 65% and expected service life of over 100,000 hours.

A+ Capable options indicated by this color background.

## Ordering Information

EXAMPLE: DSX1 LED P7 40K T3M MVOLT SPA NLTAIR2 PIRHN DDBXD

DSX1 LED							
Series	LEDs	Color temperature		Distribution		Voltage	Mounting
<b>DSX1 LED</b>	<b>Forward optics</b> P1 <b>P4</b> P7 P2 P5 P8 P3 P6 P9 <b>Rotated optics</b> P10 <sup>1</sup> P12 <sup>1</sup> P11 <sup>1</sup> P13 <sup>1</sup>	30K 40K <b>50K</b>	3000 K 4000 K <b>5000 K</b>	T1S Type I short T2S Type II short T2M Type II medium T3S Type III short T3M Type III medium <b>T4M</b> Type IV medium TFTM Forward throw medium	T5VS Type V very short T5S Type V short T5M Type V medium TSW Type V wide BLC Backlight control <sup>2</sup> LCCO Left corner cutoff <sup>2</sup> RCCO Right corner cutoff <sup>2</sup>	<b>MVOLT<sup>3</sup></b> 120 <sup>4</sup> 208 <sup>4</sup> 240 <sup>4</sup> 277 <sup>4</sup> 347 <sup>4,5</sup> 480 <sup>4,5</sup>	<b>Shipped included</b> <b>SPA</b> <b>Square pole mounting</b> RPA Round pole mounting WBA Wall bracket SPUMBA Square pole universal mounting adaptor <sup>6</sup> RPUMBA Round pole universal mounting adaptor <sup>6</sup> <b>Shipped separately</b> KMA8 DDBXD U Mast arm mounting bracket adaptor (specify finish) <sup>7</sup>

Control options	Other options	Finish (required)
<b>Shipped installed</b> NLTAIR2 nLight AIR generation 2 enabled <sup>8</sup> PIRHN Network, high/low motion/ambient sensor <sup>9</sup> PER NEMA twist-lock receptacle only (controls ordered separate) <sup>10</sup> PER5 Five-pin receptacle only (controls ordered separate) <sup>10,11</sup> PER7 Seven-pin receptacle only (controls ordered separate) <sup>10,11</sup> DMG 0-10v dimming wires pulled outside fixture (for use with an external control, ordered separately) <sup>12</sup> DS Dual switching <sup>12,13,14</sup>	PIR High/low, motion/ambient sensor, 8-15' mounting height, ambient sensor enabled at 5fc <sup>15,16</sup> PIRH High/low, motion/ambient sensor, 15-30' mounting height, ambient sensor enabled at 5fc <sup>15,16</sup> PIR1FC3V High/low, motion/ambient sensor, 8-15' mounting height, ambient sensor enabled at 1fc <sup>15,16</sup> PIRH1FC3V Bi-level, motion/ambient sensor, 15-30' mounting height, ambient sensor enabled at 1fc <sup>15,16</sup> FAO Field adjustable output <sup>14</sup>	<b>Shipped installed</b> HS House-side shield <sup>17</sup> SF Single fuse (120, 277, 347V) <sup>4</sup> DF Double fuse (208, 240, 480V) <sup>4</sup> L90 Left rotated optics <sup>1</sup> R90 Right rotated optics <sup>1</sup> <b>Shipped separately</b> BS Bird spikes <sup>18</sup> EGS External glare shield <sup>18</sup>
		DDBXD Dark bronze DBLXD Black DNAXD Natural aluminum DWHXD White DDBTXD Textured dark bronze DBLBXD Textured black DNATXD Textured natural aluminum DWHGXD Textured white



## Ordering Information

### Accessories

Ordered and shipped separately.

DLL127F 1.5 JU	Photocell - SSL twist-lock (120-277V) <sup>19</sup>
DLL347F 1.5 CUL JU	Photocell - SSL twist-lock (347V) <sup>19</sup>
DLL480F 1.5 CUL JU	Photocell - SSL twist-lock (480V) <sup>19</sup>
DSHORT SBK U	Shorting cap <sup>19</sup>
DSX1HS 30C U	House-side shield for P1, P2, P3, P4 and P5 <sup>17</sup>
DSX1HS 40C U	House-side shield for P6 and P7 <sup>17</sup>
DSX1HS 60C U	House-side shield for P8, P9, P10, P11 and P12 <sup>17</sup>
PUMBA DDBXD U*	Square and round pole universal mounting bracket (specify finish) <sup>20</sup>
KMA8 DDBXD U	Mast arm mounting bracket adaptor (specify finish) <sup>6</sup>

For more control options, visit [DTL](#) and [ROAM](#) online.

### NOTES

- P10, P11, P12 or P13 and rotated optics (L90, R90) only available together.
- Not available with HS.
- MVOLT driver operates on any line voltage from 120-277V (50/60 Hz).
- Single fuse (SF) requires 120V, 277V or 347V. Double fuse (DF) requires 208V, 240V or 480V.
- Not available in P1 or P10.
- Universal mounting brackets intended for retrofit on existing, pre-drilled poles only. 1.5 G vibration load rating per ANCI C136.31.
- Must order fixture with SPA option. Must be ordered as a separate accessory; see Accessories information. For use with 2-3/8" mast arm (not included).
- Must be ordered with PIRHN. Sensor cover available only in dark bronze, black, white and natural aluminum colors.
- Must be ordered with NLTAIR2. For more information on Light Air 2 visit [this link](#).
- Photocell ordered and shipped as a separate line item from Acuity Brands Controls. See accessories. Not available with DS option. Shorting cap included.
- If ROAM® node required, it must be ordered and shipped as a separate line item from Acuity Brands Controls. Node with integral dimming.
- Provides 50/50 fixture operation via (2) independent drivers. Not available with PER, PER5, PER7, PIR or PIRH. Not available P1, P2, P3, P4 or P5.
- Requires (2) separately switched circuits with isolated neutral. See Outdoor Control Technical Guide for details.
- Reference Motion Sensor table on page 4.
- Reference controls options table on page 4 to see functionality.
- Not available with other dimming controls options
- Not available with BLC, LCCO and RCCO distribution. Also available as a separate accessory; see Accessories information.
- Must be ordered with fixture for factory pre-drilling.
- Requires luminaire to be specified with PER, PER5 or PER7 option. See PER Table on page 3.
- For retrofit use only.

## Options

### EGS - External Glare Shield

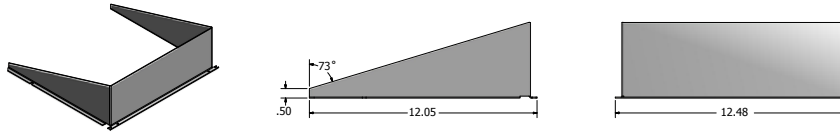

## Drilling

### HANDHOLE ORIENTATION

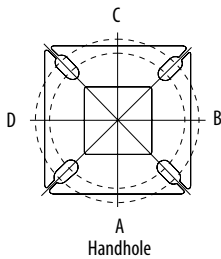

### Tenon Mounting Slipfitter\*\*

Tenon O.D.	Mounting	Single Unit	2 @ 180	2 @ 90	3 @ 120	3 @ 90	4 @ 90
2-3/8"	SPA/RPA	AS3-5 190	AS3-5 280	AS3-5 290	AS3-5 320	AS3-5 390	AS3-5 490
	SPUMBA	AS3-5 190	AS3-5 280	AS4-5 290	AS3-5 320	AS4-5 390	AS4-5 490
	RUPUMBA	AS3-5 190	AS3-5 280		AS3-5 320		
2-7/8"	SPA/RPA	AST25-190	AST25-280	AST25-290	AST25-320	AST25-390	AST25-490
	SPUMBA	AST25-190	AST25-280		AST25-320		
	RUPUMBA	AST25-190	AST25-280		AST25-320		
4"	SPA/RPA	AST35-190	AST35-280	AST35-290	AST35-320	AST35-390	AST35-490
	SPUMBA	AST35-190	AST35-280	AST35-290	AST35-320	AST35-390	AST35-490
	RUPUMBA	AST35-190	AST35-280		AST35-320		

Template #8

Top of Pole

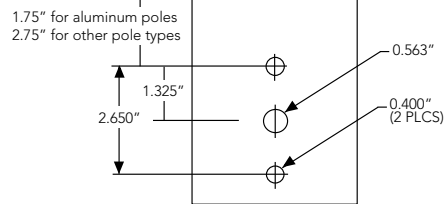

Mounting Option	Drilling Template	Single	2 @ 180	2 @ 90	3 @ 90	3 @ 120	4 @ 90
Head Location		Side B	Side B & D	Side B & C	Side B, C & D	Round Pole Only	Side A, B, C & D
Drill Nomenclature	#8	DM19AS	DM28AS	DM29AS	DM39AS	DM32AS	DM49AS

	Drilling Template	Minimum Acceptable Outside Pole Dimension					
SPA	#8	2-7/8"	2-7/8"	3.5"	3.5"	3"	3.5"
RPA	#8	2-7/8"	2-7/8"	3.5"	3.5"	3"	3.5"
SPUMBA	#5	2-7/8"	3"	4"	4"	3.5"	4"
RPUMBA	#5	2-7/8"	3.5"	5"	5"	3.5"	5"

# Photometric Diagrams

To see complete photometric reports or download .ies files for this product, visit Lithonia Lighting's [D-Series Area Size 1 homepage](#).

Isofootcandle plots for the DSX1 LED 60C 1000 40K. Distances are in units of mounting height (25').

### LEGEND

- 0.1 fc
- 0.5 fc
- 1.0 fc

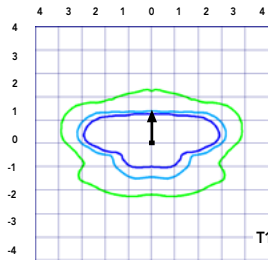

Test No. LT.L23211 tested in accordance with IESNA LM-79-08.

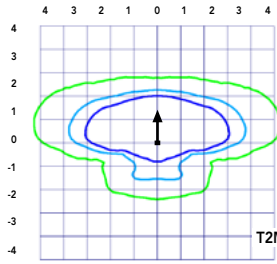

Test No. LT.L23164B tested in accordance with IESNA LM-79-08.

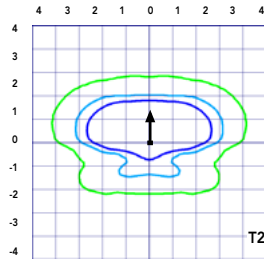

Test No. LT.L23222 tested in accordance with IESNA LM-79-08.

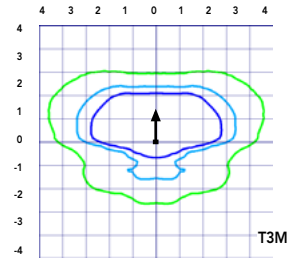

Test No. LT.L23271 tested in accordance with IESNA LM-79-08.

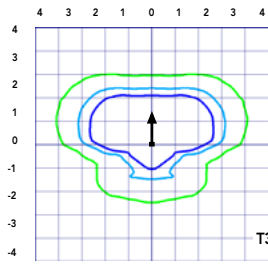

Test No. LT.L23211 tested in accordance with IESNA LM-79-08.

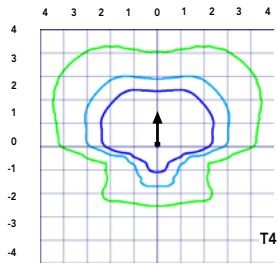

Test No. LT.L23164B tested in accordance with IESNA LM-79-08.

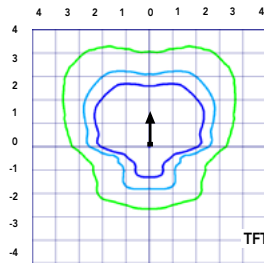

Test No. LT.L23222 tested in accordance with IESNA LM-79-08.

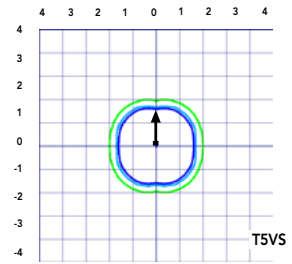

Test No. LT.L23271 tested in accordance with IESNA LM-79-08.

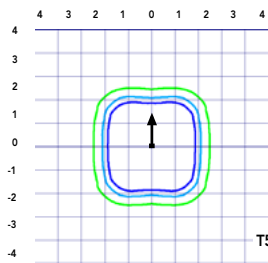

Test No. LT.L23211 tested in accordance with IESNA LM-79-08.

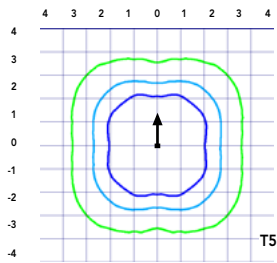

Test No. LT.L23164B tested in accordance with IESNA LM-79-08.

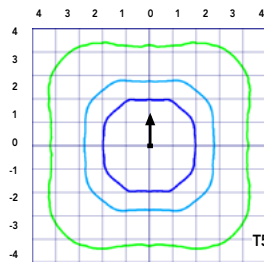

Test No. LT.L23222 tested in accordance with IESNA LM-79-08.

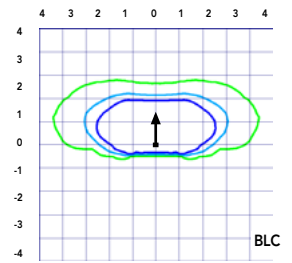

Test No. LT.L23271 tested in accordance with IESNA LM-79-08.

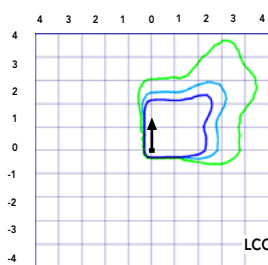

Test No. LT.L23211 tested in accordance with IESNA LM-79-08.

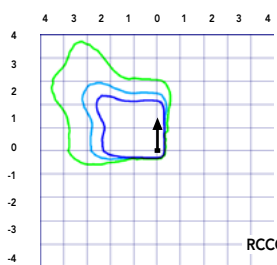

Test No. LT.L23164B tested in accordance with IESNA LM-79-08.

## Performance Data

### Lumen Ambient Temperature (LAT) Multipliers

Use these factors to determine relative lumen output for average ambient temperatures from 0-40°C (32-104°F).

Ambient		Lumen Multiplier
0°C	32°F	1.04
5°C	41°F	1.04
10°C	50°F	1.03
15°C	59°F	1.02
20°C	68°F	1.01
<b>25°C</b>	<b>77°F</b>	<b>1.00</b>
30°C	86°F	0.99
35°C	95°F	0.98
40°C	104°F	0.97

### Projected LED Lumen Maintenance

Data references the extrapolated performance projections for the platforms noted in a **25°C ambient**, based on 10,000 hours of LED testing (tested per IESNA LM-80-08 and projected per IESNA TM-21-11).

To calculate LLF, use the lumen maintenance factor that corresponds to the desired number of operating hours below. For other lumen maintenance values, contact factory.

Operating Hours	Lumen Maintenance Factor
0	1.00
25,000	0.96
50,000	0.92
100,000	0.85

#### Motion Sensor Default Settings

Option	Dimmed State	High Level (when triggered)	Photocell Operation	Dwell Time	Ramp-up Time	Ramp-down Time
PIR or PIRH	3V (37%) Output	10V (100%) Output	Enabled @ 5FC	5 min	3 sec	5 min
*PIR1FC3V or PIRH1FC3V	3V (37%) Output	10V (100%) Output	Enabled @ 1FC	5 min	3 sec	5 min

\*for use when motion sensor is used as dusk to dawn control.

### Electrical Load

	Performance Package	LED Count	Drive Current	Wattage	Current (A)					
					120	208	240	277	347	480
Forward Optics (Non-Rotated)	P1	30	530	54	0.45	0.26	0.23	0.19	0.10	0.12
	P2	30	700	70	0.59	0.34	0.30	0.25	0.20	0.16
	P3	30	1050	102	0.86	0.50	0.44	0.38	0.30	0.22
	P4	30	1250	125	1.06	0.60	0.52	0.46	0.37	0.27
	P5	30	1400	138	1.16	0.67	0.58	0.51	0.40	0.29
	P6	40	1250	163	1.36	0.78	0.68	0.59	0.47	0.34
	P7	40	1400	183	1.53	0.88	0.76	0.66	0.53	0.38
	P8	60	1050	207	1.74	0.98	0.87	0.76	0.64	0.49
	P9	60	1250	241	2.01	1.16	1.01	0.89	0.70	0.51
Rotated Optics (Requires L90 or R90)	P10	60	530	106	0.90	0.52	0.47	0.43	0.33	0.27
	P11	60	700	137	1.15	0.67	0.60	0.53	0.42	0.32
	P12	60	1050	207	1.74	0.99	0.87	0.76	0.60	0.46
	P13	60	1250	231	1.93	1.12	0.97	0.86	0.67	0.49

#### Controls Options

Nomenclature	Description	Functionality	Primary control device	Notes
FA0	Field adjustable output device installed inside the luminaire; wired to the driver dimming leads.	Allows the luminaire to be manually dimmed, effectively trimming the light output.	FA0 device	Cannot be used with other controls options that need the 0-10V leads
DS	Drivers wired independently for 50/50 luminaire operation	The luminaire is wired to two separate circuits, allowing for 50/50 operation.	Independently wired drivers	Requires two separately switched circuits. Consider nLight AIR as a more cost effective alternative.
PERS or PER7	Twist-lock photocell receptacle	Compatible with standard twist-lock photocells for dusk to dawn operation, or advanced control nodes that provide 0-10V dimming signals.	Twist-lock photocells such as DLL Elite or advanced control nodes such as ROAM.	Pins 4 & 5 to dimming leads on driver, Pins 6 & 7 are capped inside luminaire
PIR or PIRH	Motion sensors with integral photocell. PIR for 8-15' mounting; PIRH for 15-30' mounting	Luminaires dim when no occupancy is detected.	Acuity Controls SBOR	Also available with PIRH1FC3V when the sensor photocell is used for dusk-to-dawn operation.
NLTAIR2 PIRHN	nLight AIR enabled luminaire for motion sensing, photocell and wireless communication.	Motion and ambient light sensing with group response. Scheduled dimming with motion sensor over-ride when wirelessly connected to the nLight Eclipse.	nLight Air rSDGR	nLight AIR sensors can be programmed and commissioned from the ground using the CIAIRity Pro app.



# Performance Data

## Lumen Output

Lumen values are from photometric tests performed in accordance with IESNA LM-79-08. Data is considered to be representative of the configurations shown, within the tolerances allowed by Lighting Facts Contact factory for performance data on any configurations not shown here.

Forward Optics																			
LED Count	Drive Current	Power Package	System Watts	Dist. Type	30K (3000 K, 70 CRI)					40K (4000 K, 70 CRI)					50K (5000 K, 70 CRI)				
					Lumens	B	U	G	LPW	Lumens	B	U	G	LPW	Lumens	B	U	G	LPW
30	530	P1	54W	T1S	6,457	2	0	2	120	6,956	2	0	2	129	7,044	2	0	2	130
				T2S	6,450	2	0	2	119	6,949	2	0	2	129	7,037	2	0	2	130
				T2M	6,483	1	0	1	120	6,984	2	0	2	129	7,073	2	0	2	131
				T3S	6,279	2	0	2	116	6,764	2	0	2	125	6,850	2	0	2	127
				T3M	6,468	1	0	2	120	6,967	1	0	2	129	7,056	1	0	2	131
				T4M	6,327	1	0	2	117	6,816	1	0	2	126	6,902	1	0	2	128
				TFTM	6,464	1	0	2	120	6,963	1	0	2	129	7,051	1	0	2	131
				TSVS	6,722	2	0	0	124	7,242	3	0	0	134	7,334	3	0	0	136
				T5S	6,728	2	0	1	125	7,248	2	0	1	134	7,340	2	0	1	136
				T5M	6,711	3	0	1	124	7,229	3	0	1	134	7,321	3	0	2	136
				TSW	6,667	3	0	2	123	7,182	3	0	2	133	7,273	3	0	2	135
				BLC	5,299	1	0	1	98	5,709	1	0	2	106	5,781	1	0	2	107
				LCCO	3,943	1	0	2	73	4,248	1	0	2	79	4,302	1	0	2	80
				RCCO	3,943	1	0	2	73	4,248	1	0	2	79	4,302	1	0	2	80
30	700	P2	70W	T1S	8,249	2	0	2	118	8,886	2	0	2	127	8,999	2	0	2	129
				T2S	8,240	2	0	2	118	8,877	2	0	2	127	8,989	2	0	2	128
				T2M	8,283	2	0	2	118	8,923	2	0	2	127	9,036	2	0	2	129
				T3S	8,021	2	0	2	115	8,641	2	0	2	123	8,751	2	0	2	125
				T3M	8,263	2	0	2	118	8,901	2	0	2	127	9,014	2	0	2	129
				T4M	8,083	2	0	2	115	8,708	2	0	2	124	8,818	2	0	2	126
				TFTM	8,257	2	0	2	118	8,896	2	0	2	127	9,008	2	0	2	129
				TSVS	8,588	3	0	0	123	9,252	3	0	0	132	9,369	3	0	0	134
				T5S	8,595	3	0	1	123	9,259	3	0	1	132	9,376	3	0	1	134
				T5M	8,573	3	0	2	122	9,236	3	0	2	132	9,353	3	0	2	134
				TSW	8,517	3	0	2	122	9,175	4	0	2	131	9,291	4	0	2	133
				BLC	6,770	1	0	2	97	7,293	1	0	2	104	7,386	1	0	2	106
				LCCO	5,038	1	0	2	72	5,427	1	0	2	78	5,496	1	0	2	79
				RCCO	5,038	1	0	2	72	5,427	1	0	2	78	5,496	1	0	2	79
30	1050	P3	102W	T1S	11,661	2	0	2	114	12,562	3	0	3	123	12,721	3	0	3	125
				T2S	11,648	2	0	2	114	12,548	3	0	3	123	12,707	3	0	3	125
				T2M	11,708	2	0	2	115	12,613	2	0	2	124	12,773	2	0	2	125
				T3S	11,339	2	0	2	111	12,215	3	0	3	120	12,370	3	0	3	121
				T3M	11,680	2	0	2	115	12,582	2	0	2	123	12,742	2	0	2	125
				T4M	11,426	2	0	3	112	12,309	2	0	3	121	12,465	2	0	3	122
				TFTM	11,673	2	0	2	114	12,575	2	0	3	123	12,734	2	0	3	125
				TSVS	12,140	3	0	1	119	13,078	3	0	1	128	13,244	3	0	1	130
				T5S	12,150	3	0	1	119	13,089	3	0	1	128	13,254	3	0	1	130
				T5M	12,119	4	0	2	119	13,056	4	0	2	128	13,221	4	0	2	130
				TSW	12,040	4	0	3	118	12,970	4	0	3	127	13,134	4	0	3	129
				BLC	9,570	1	0	2	94	10,310	1	0	2	101	10,440	1	0	2	102
				LCCO	7,121	1	0	3	70	7,671	1	0	3	75	7,768	1	0	3	76
				RCCO	7,121	1	0	3	70	7,671	1	0	3	75	7,768	1	0	3	76
30	1250	P4	125W	T1S	13,435	3	0	3	107	14,473	3	0	3	116	14,657	3	0	3	117
				T2S	13,421	3	0	3	107	14,458	3	0	3	116	14,641	3	0	3	117
				T2M	13,490	2	0	2	108	14,532	3	0	3	116	14,716	3	0	3	118
				T3S	13,064	3	0	3	105	14,074	3	0	3	113	14,252	3	0	3	114
				T3M	13,457	2	0	2	108	14,497	2	0	2	116	14,681	2	0	2	117
				T4M	13,165	2	0	3	105	14,182	2	0	3	113	14,362	2	0	3	115
				TFTM	13,449	2	0	3	108	14,488	2	0	3	116	14,672	2	0	3	117
				TSVS	13,987	4	0	1	112	15,068	4	0	1	121	15,259	4	0	1	122
				T5S	13,999	3	0	1	112	15,080	3	0	1	121	15,271	3	0	1	122
				T5M	13,963	4	0	2	112	15,042	4	0	2	120	15,233	4	0	2	122
				TSW	13,872	4	0	3	111	14,944	4	0	3	120	15,133	4	0	3	121
				BLC	11,027	1	0	2	88	11,879	1	0	2	95	12,029	1	0	2	96
				LCCO	8,205	1	0	3	66	8,839	1	0	3	71	8,951	1	0	3	72
				RCCO	8,205	1	0	3	66	8,839	1	0	3	71	8,951	1	0	3	72
30	1400	P5	138W	T1S	14,679	3	0	3	106	15,814	3	0	3	115	16,014	3	0	3	116
				T2S	14,664	3	0	3	106	15,797	3	0	3	114	15,997	3	0	3	116
				T2M	14,739	3	0	3	107	15,878	3	0	3	115	16,079	3	0	3	117
				T3S	14,274	3	0	3	103	15,377	3	0	3	111	15,572	3	0	3	113
				T3M	14,704	2	0	3	107	15,840	3	0	3	115	16,040	3	0	3	116
				T4M	14,384	2	0	3	104	15,496	3	0	3	112	15,692	3	0	3	114
				TFTM	14,695	2	0	3	106	15,830	3	0	3	115	16,030	3	0	3	116
				TSVS	15,283	4	0	1	111	16,464	4	0	1	119	16,672	4	0	1	121
				T5S	15,295	3	0	1	111	16,477	4	0	1	119	16,686	4	0	1	121
				T5M	15,257	4	0	2	111	16,435	4	0	2	119	16,644	4	0	2	121
				TSW	15,157	4	0	3	110	16,328	4	0	3	118	16,534	4	0	3	120
				BLC	12,048	1	0	2	87	12,979	1	0	2	94	13,143	1	0	2	95
				LCCO	8,965	1	0	3	65	9,657	1	0	3	70	9,780	1	0	3	71
				RCCO	8,965	1	0	3	65	9,657	1	0	3	70	9,780	1	0	3	71



# Performance Data

## Lumen Output

Lumen values are from photometric tests performed in accordance with IESNA LM-79-08. Data is considered to be representative of the configurations shown, within the tolerances allowed by Lighting Facts. Contact factory for performance data on any configurations not shown here.

Forward Optics																			
LED Count	Drive Current	Power Package	System Watts	Dist. Type	30K (3000 K, 70 CRI)					40K (4000 K, 70 CRI)					50K (5000 K, 70 CRI)				
					Lumens	B	U	G	LPW	Lumens	B	U	G	LPW	Lumens	B	U	G	LPW
40	1250	P6	163W	T1S	17,654	3	0	3	108	19,018	3	0	3	117	19,259	3	0	3	118
				T2S	17,635	3	0	3	108	18,998	3	0	3	117	19,238	3	0	3	118
				T2M	17,726	3	0	3	109	19,096	3	0	3	117	19,337	3	0	3	119
				T3S	17,167	3	0	3	105	18,493	3	0	3	113	18,727	3	0	3	115
				T3M	17,683	3	0	3	108	19,049	3	0	3	117	19,290	3	0	3	118
				T4M	17,299	3	0	3	106	18,635	3	0	4	114	18,871	3	0	4	116
				TFTM	17,672	3	0	3	108	19,038	3	0	4	117	19,279	3	0	4	118
				TSVS	18,379	4	0	1	113	19,800	4	0	1	121	20,050	4	0	1	123
				T5S	18,394	4	0	2	113	19,816	4	0	2	122	20,066	4	0	2	123
				T5M	18,348	4	0	2	113	19,766	4	0	2	121	20,016	4	0	2	123
				TSW	18,228	5	0	3	112	19,636	5	0	3	120	19,885	5	0	3	122
				BLC	14,489	2	0	2	89	15,609	2	0	3	96	15,806	2	0	3	97
				LCCO	10,781	1	0	3	66	11,614	1	0	3	71	11,761	2	0	3	72
				RCCO	10,781	1	0	3	66	11,614	1	0	3	71	11,761	2	0	3	72
40	1400	P7	183W	T1S	19,227	3	0	3	105	20,712	3	0	3	113	20,975	3	0	3	115
				T2S	19,206	3	0	3	105	20,690	3	0	3	113	20,952	3	0	3	114
				T2M	19,305	3	0	3	105	20,797	3	0	3	114	21,060	3	0	3	115
				T3S	18,696	3	0	3	102	20,141	3	0	3	110	20,396	3	0	4	111
				T3M	19,258	3	0	3	105	20,746	3	0	3	113	21,009	3	0	3	115
				T4M	18,840	3	0	4	103	20,296	3	0	4	111	20,553	3	0	4	112
				TFTM	19,246	3	0	4	105	20,734	3	0	4	113	20,996	3	0	4	115
				TSVS	20,017	4	0	1	109	21,564	4	0	1	118	21,837	4	0	1	119
				T5S	20,033	4	0	2	109	21,581	4	0	2	118	21,854	4	0	2	119
				T5M	19,983	4	0	2	109	21,527	5	0	3	118	21,799	5	0	3	119
				TSW	19,852	5	0	3	108	21,386	5	0	3	117	21,656	5	0	3	118
				BLC	15,780	2	0	3	86	16,999	2	0	3	93	17,214	2	0	3	94
				LCCO	11,742	2	0	3	64	12,649	2	0	3	69	12,809	2	0	3	70
				RCCO	11,742	2	0	3	64	12,649	2	0	3	69	12,809	2	0	3	70
60	1050	P8	207W	T1S	22,490	3	0	3	109	24,228	3	0	3	117	24,535	3	0	3	119
				T2S	22,466	3	0	4	109	24,202	3	0	4	117	24,509	3	0	4	118
				T2M	22,582	3	0	3	109	24,327	3	0	3	118	24,635	3	0	3	119
				T3S	21,870	3	0	4	106	23,560	3	0	4	114	23,858	3	0	4	115
				T3M	22,527	3	0	4	109	24,268	3	0	4	117	24,575	3	0	4	119
				T4M	22,038	3	0	4	106	23,741	3	0	4	115	24,041	3	0	4	116
				TFTM	22,513	3	0	4	109	24,253	3	0	4	117	24,560	3	0	4	119
				TSVS	23,415	5	0	1	113	25,224	5	0	1	122	25,543	5	0	1	123
				T5S	23,434	4	0	2	113	25,244	4	0	2	122	25,564	4	0	2	123
				T5M	23,374	5	0	3	113	25,181	5	0	3	122	25,499	5	0	3	123
				TSW	23,221	5	0	4	112	25,016	5	0	4	121	25,332	5	0	4	122
				BLC	18,458	2	0	3	89	19,885	2	0	3	96	20,136	2	0	3	97
				LCCO	13,735	2	0	3	66	14,796	2	0	4	71	14,983	2	0	4	72
				RCCO	13,735	2	0	3	66	14,796	2	0	4	71	14,983	2	0	4	72
60	1250	P9	241W	T1S	25,575	3	0	3	106	27,551	3	0	3	114	27,900	3	0	3	116
				T2S	25,548	3	0	4	106	27,522	3	0	4	114	27,871	3	0	4	116
				T2M	25,680	3	0	3	107	27,664	3	0	3	115	28,014	3	0	3	116
				T3S	24,870	3	0	4	103	26,791	3	0	4	111	27,130	3	0	4	113
				T3M	25,617	3	0	4	106	27,597	3	0	4	115	27,946	3	0	4	116
				T4M	25,061	3	0	4	104	26,997	3	0	4	112	27,339	3	0	4	113
				TFTM	25,602	3	0	4	106	27,580	3	0	4	114	27,929	3	0	4	116
				TSVS	26,626	5	0	1	110	28,684	5	0	1	119	29,047	5	0	1	121
				T5S	26,648	4	0	2	111	28,707	5	0	2	119	29,070	5	0	2	121
				T5M	26,581	5	0	3	110	28,635	5	0	3	119	28,997	5	0	3	120
				TSW	26,406	5	0	4	110	28,447	5	0	4	118	28,807	5	0	4	120
				BLC	20,990	2	0	3	87	22,612	2	0	3	94	22,898	2	0	3	95
				LCCO	15,619	2	0	4	65	16,825	2	0	4	70	17,038	2	0	4	71
				RCCO	15,619	2	0	4	65	16,825	2	0	4	70	17,038	2	0	4	71

# Performance Data

## Lumen Output

Lumen values are from photometric tests performed in accordance with IESNA LM-79-08. Data is considered to be representative of the configurations shown, within the tolerances allowed by Lighting Facts. Contact factory for performance data on any configurations not shown here.

Rotated Optics																			
LED Count	Drive Current	Power Package	System Watts	Dist. Type	30K (3000 K, 70 CRI)					40K (4000 K, 70 CRI)					50K (5000 K, 70 CRI)				
					Lumens	B	U	G	LPW	Lumens	B	U	G	LPW	Lumens	B	U	G	LPW
60	530	P10	106W	T1S	13,042	3	0	3	123	14,050	3	0	3	133	14,228	3	0	3	134
				T2S	12,967	4	0	4	122	13,969	4	0	4	132	14,146	4	0	4	133
				T2M	13,201	3	0	3	125	14,221	3	0	3	134	14,401	3	0	3	136
				T3S	12,766	4	0	4	120	13,752	4	0	4	130	13,926	4	0	4	131
				T3M	13,193	4	0	4	124	14,213	4	0	4	134	14,393	4	0	4	136
				T4M	12,944	4	0	4	122	13,945	4	0	4	132	14,121	4	0	4	133
				TFTM	13,279	4	0	4	125	14,305	4	0	4	135	14,486	4	0	4	137
				TSVS	13,372	3	0	1	126	14,405	4	0	1	136	14,588	4	0	1	138
				T5S	13,260	3	0	1	125	14,284	3	0	1	135	14,465	3	0	1	136
				T5M	13,256	4	0	2	125	14,281	4	0	2	135	14,462	4	0	2	136
				TSW	13,137	4	0	3	124	14,153	4	0	3	134	14,332	4	0	3	135
				BLC	10,906	3	0	3	103	11,749	3	0	3	111	11,898	3	0	3	112
				LCCO	7,789	1	0	3	73	8,391	1	0	3	79	8,497	1	0	3	80
				RCCO	7,779	4	0	4	73	8,380	4	0	4	79	8,486	4	0	4	80
60	700	P11	137W	T1S	16,556	3	0	3	121	17,835	3	0	3	130	18,061	4	0	4	132
				T2S	16,461	4	0	4	120	17,733	4	0	4	129	17,957	4	0	4	131
				T2M	16,758	4	0	4	122	18,053	4	0	4	132	18,281	4	0	4	133
				T3S	16,205	4	0	4	118	17,457	4	0	4	127	17,678	4	0	4	129
				T3M	16,748	4	0	4	122	18,042	4	0	4	132	18,271	4	0	4	133
				T4M	16,432	4	0	4	120	17,702	4	0	4	129	17,926	4	0	4	131
				TFTM	16,857	4	0	4	123	18,159	4	0	4	133	18,389	4	0	4	134
				TSVS	16,975	4	0	1	124	18,287	4	0	1	133	18,518	4	0	1	135
				T5S	16,832	4	0	1	123	18,133	4	0	2	132	18,362	4	0	2	134
				T5M	16,828	4	0	2	123	18,128	4	0	2	132	18,358	4	0	2	134
				TSW	16,677	4	0	3	122	17,966	5	0	3	131	18,193	5	0	3	133
				BLC	13,845	3	0	3	101	14,915	3	0	3	109	15,103	3	0	3	110
				LCCO	9,888	1	0	3	72	10,652	2	0	3	78	10,787	2	0	3	79
				RCCO	9,875	4	0	4	72	10,638	4	0	4	78	10,773	4	0	4	79
60	1050	P12	207W	T1S	22,996	4	0	4	111	24,773	4	0	4	120	25,087	4	0	4	121
				T2S	22,864	4	0	4	110	24,631	5	0	5	119	24,943	5	0	5	120
				T2M	23,277	4	0	4	112	25,075	4	0	4	121	25,393	4	0	4	123
				T3S	22,509	4	0	4	109	24,248	5	0	5	117	24,555	5	0	5	119
				T3M	23,263	4	0	4	112	25,061	4	0	4	121	25,378	4	0	4	123
				T4M	22,824	5	0	5	110	24,588	5	0	5	119	24,899	5	0	5	120
				TFTM	23,414	5	0	5	113	25,223	5	0	5	122	25,543	5	0	5	123
				TSVS	23,579	5	0	1	114	25,401	5	0	1	123	25,722	5	0	1	124
				T5S	23,380	4	0	2	113	25,187	4	0	2	122	25,506	4	0	2	123
				T5M	23,374	5	0	3	113	25,181	5	0	3	122	25,499	5	0	3	123
				TSW	23,165	5	0	4	112	24,955	5	0	4	121	25,271	5	0	4	122
				BLC	19,231	4	0	4	93	20,717	4	0	4	100	20,979	4	0	4	101
				LCCO	13,734	2	0	3	66	14,796	2	0	4	71	14,983	2	0	4	72
				RCCO	13,716	4	0	4	66	14,776	4	0	4	71	14,963	4	0	4	72
60	1250	P13	231W	T1S	25,400	4	0	4	110	27,363	4	0	4	118	27,709	4	0	4	120
				T2S	25,254	5	0	5	109	27,205	5	0	5	118	27,550	5	0	5	119
				T2M	25,710	4	0	4	111	27,696	4	0	4	120	28,047	4	0	4	121
				T3S	24,862	5	0	5	108	26,783	5	0	5	116	27,122	5	0	5	117
				T3M	25,695	5	0	5	111	27,680	5	0	5	120	28,031	5	0	5	121
				T4M	25,210	5	0	5	109	27,158	5	0	5	118	27,502	5	0	5	119
				TFTM	25,861	5	0	5	112	27,860	5	0	5	121	28,212	5	0	5	122
				TSVS	26,043	5	0	1	113	28,056	5	0	1	121	28,411	5	0	1	123
				T5S	25,824	4	0	2	112	27,819	5	0	2	120	28,172	5	0	2	122
				T5M	25,818	5	0	3	112	27,813	5	0	3	120	28,165	5	0	3	122
				TSW	25,586	5	0	4	111	27,563	5	0	4	119	27,912	5	0	4	121
				BLC	21,241	4	0	4	92	22,882	4	0	4	99	23,172	4	0	4	100
				LCCO	15,170	2	0	4	66	16,342	2	0	4	71	16,549	2	0	4	72
				RCCO	15,150	5	0	5	66	16,321	5	0	5	71	16,527	5	0	5	72

## Capable Luminaire

This item is an A+ capable luminaire, which has been designed and tested to provide consistent color appearance and system-level interoperability.

- All configurations of this luminaire meet the Acuity Brands' specification for chromatic consistency
- This luminaire is A+ Certified when ordered with DTL® controls marked by a shaded background. DTL DLL equipped luminaires meet the A+ specification for luminaire to photocontrol interoperability<sup>1</sup>
- This luminaire is part of an A+ Certified solution for ROAM® or XPoint™ Wireless control networks, providing out-of-the-box control compatibility with simple commissioning, when ordered with drivers and control options marked by a shaded background<sup>1</sup>

To learn more about A+, visit [www.acuitybrands.com/aplus](http://www.acuitybrands.com/aplus).

1. See ordering tree for details.
2. A+ Certified Solutions for ROAM require the order of one ROAM node per luminaire. Sold Separately: [Link to Roam](#); [Link to DTL DLL](#)

## FEATURES & SPECIFICATIONS

### INTENDED USE

The sleek design of the D-Series Size 1 reflects the embedded high performance LED technology. It is ideal for many commercial and municipal applications, such as parking lots, plazas, campuses, and streetscapes.

### CONSTRUCTION

Single-piece die-cast aluminum housing has integral heat sink fins to optimize thermal management through conductive and convective cooling. Modular design allows for ease of maintenance and future light engine upgrades. The LED drivers are mounted in direct contact with the casting to promote low operating temperature and long life. Housing is completely sealed against moisture and environmental contaminants (IP65). Low EPA (1.01 ft<sup>2</sup>) for optimized pole wind loading.

### FINISH

Exterior parts are protected by a zinc-infused Super Durable TGIC thermoset powder coat finish that provides superior resistance to corrosion and weathering. A tightly controlled multi-stage process ensures a minimum 3 mils thickness for a finish that can withstand extreme climate changes without cracking or peeling. Available in both textured and non-textured finishes.

### OPTICS

Precision-molded proprietary acrylic lenses are engineered for superior area lighting distribution, uniformity, and pole spacing. Light engines are available in standard 3000 K, 4000 K and 5000 K (70 CRI) configurations. The D-Series Size 1 has zero uplight and qualifies as a Nighttime Friendly™ product, meaning it is consistent with the LEED® and Green Globes™ criteria for eliminating wasteful uplight.

### ELECTRICAL

Light engine configurations consist of high-efficacy LEDs mounted to metal-core circuit boards to maximize heat dissipation and promote long life (up to L85/100,000 hours at 25°C). Class 1 electronic drivers are designed to have a power factor >90%, THD <20%, and an expected life of 100,000 hours with <1% failure rate. Easily serviceable 10kV surge protection device meets a minimum Category C Low operation (per ANSI/IEEE C62.41.2).

### STANDARD CONTROLS

The DSX1 LED area luminaire has a number of control options. Dusk to dawn controls can be utilized via optional NEMA twist-lock photocell receptacles. Integrated motion sensors with on-board photocells feature field-adjustable programming and are suitable for mounting heights up to 30 feet.

### nLIGHT AIR CONTROLS

The DSX1 LED area luminaire is also available with nLight® AIR for the ultimate in wireless control. This powerful controls platform provides out-of-the-box basic motion sensing and photocontrol functionality and is suitable for mounting heights up to 40 feet. Once commissioned using a smartphone and the easy-to-use CLAIRITY app, nLight AIR equipped luminaires can be grouped, resulting in motion sensor and photocell group response without the need for additional equipment. Scheduled dimming with motion sensor over-ride can be achieved when used with the nLight Eclipse. Additional information about nLight Air can be found here.

### INSTALLATION

Included mounting block and integral arm facilitate quick and easy installation. Stainless steel bolts fasten the mounting block securely to poles and walls, enabling the D-Series Size 1 to withstand up to a 3.0 G vibration load rating per ANSI C136.31. The D-Series Size 1 utilizes the AERIS™ series pole drilling pattern (template #8). NEMA photocontrol receptacle are also available.

### LISTINGS

UL Listed for wet locations. Light engines are IP66 rated; luminaire is IP65 rated. Rated for -40°C minimum ambient. U.S. Patent No. D672,492 S. International patent pending.

DesignLights Consortium® (DLC) Premium qualified product and DLC qualified product.

Not all versions of this product may be DLC Premium qualified or DLC qualified. Please check the DLC Qualified Products List at [www.designlights.org/QPL](http://www.designlights.org/QPL) to confirm which versions are qualified.

International Dark-Sky Association (IDA) Fixture Seal of Approval (FSA) is available for all products on this page utilizing 3000K color temperature only.

### WARRANTY

5-year limited warranty. Complete warranty terms located at: [www.acuitybrands.com/CustomResources/Terms\\_and\\_conditions.aspx](http://www.acuitybrands.com/CustomResources/Terms_and_conditions.aspx)

**Note:** Actual performance may differ as a result of end-user environment and application.

All values are design or typical values, measured under laboratory conditions at 25 °C.

Specifications subject to change without notice.





# D-Series Size 1 LED Area Luminaire

d#series



Catalog Number
Notes
Type

Hit the Tab key or mouse over the page to see all interactive elements.

## Specifications

<b>EPA:</b>	1.01 ft <sup>2</sup> (0.09 m <sup>2</sup> )
<b>Length:</b>	33" (83.8 cm)
<b>Width:</b>	13" (33.0 cm)
<b>Height H1:</b>	7-1/2" (19.0 cm)
<b>Height H2:</b>	3-1/2"
<b>Weight (max):</b>	27 lbs (12.2 kg)

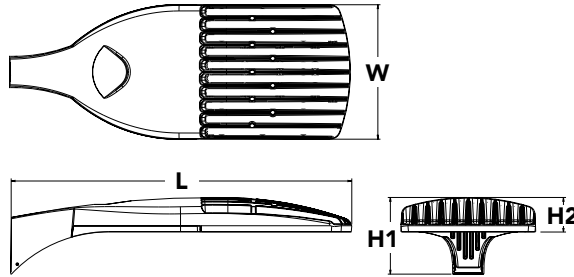

## Introduction

The modern styling of the D-Series is striking yet unobtrusive - making a bold, progressive statement even as it blends seamlessly with its environment. The D-Series distills the benefits of the latest in LED technology into a high performance, high efficacy, long-life luminaire.

The outstanding photometric performance results in sites with excellent uniformity, greater pole spacing and lower power density. It is ideal for replacing up to 750W metal halide in pedestrian and area lighting applications with typical energy savings of 65% and expected service life of over 100,000 hours.

A+ Capable options indicated by this color background.

## Ordering Information

**EXAMPLE:** DSX1 LED P7 40K T3M MVOLT SPA NLTAIR2 PIRHN DDBXD

DSX1 LED		Color temperature		Distribution		Voltage	Mounting		
Series	LEDs								
<b>DSX1 LED</b>	<b>Forward optics</b>	30K	3000 K	T1S	Type I short	T5VS	Type V very short	<b>MVOLT<sup>3</sup></b>	<b>Shipped included</b>
	P1 <b>P4</b> P7	40K	4000 K	T2S	Type II short	T5S	Type V short	120 <sup>4</sup>	SPA Square pole mounting
	P2 P5 P8	<b>50K</b>	<b>5000 K</b>	T2M	Type II medium	T5M	Type V medium	208 <sup>4</sup>	RPA Round pole mounting
	P3 P6 P9			T3S	Type III short	T5W	Type V wide	240 <sup>4</sup>	<b>WBA</b> <b>Wall bracket</b>
	<b>Rotated optics</b>			T3M	Type III medium	BLC	Backlight control <sup>2</sup>	277 <sup>4</sup>	SPUMBA Square pole universal mounting adaptor <sup>6</sup>
	P10 <sup>1</sup> P12 <sup>1</sup>			<b>T4M</b>	Type IV medium	LCCO	Left corner cutoff <sup>2</sup>	347 <sup>4,5</sup>	RPUMBA Round pole universal mounting adaptor <sup>6</sup>
	P11 <sup>1</sup> P13 <sup>1</sup>			TFTM	Forward throw medium	RCCO	Right corner cutoff <sup>2</sup>	480 <sup>4,5</sup>	<b>Shipped separately</b>
									KMA8 DDBXD U Mast arm mounting bracket adaptor (specify finish) <sup>7</sup>

Control options	Other options	Finish (required)
<p><b>Shipped installed</b></p> <p>NLTAIR2 nLight AIR generation 2 enabled<sup>8</sup></p> <p>PIRHN Network, high/low motion/ambient sensor<sup>9</sup></p> <p>PER NEMA twist-lock receptacle only (controls ordered separate)<sup>10</sup></p> <p>PER5 Five-pin receptacle only (controls ordered separate)<sup>10,11</sup></p> <p>PER7 Seven-pin receptacle only (controls ordered separate)<sup>10,11</sup></p> <p>DMG 0-10v dimming wires pulled outside fixture (for use with an external control, ordered separately)<sup>12</sup></p> <p>DS Dual switching<sup>12,13,14</sup></p>	<p>PIR High/low, motion/ambient sensor, 8-15' mounting height, ambient sensor enabled at 5fc<sup>15,16</sup></p> <p>PIRHN High/low, motion/ambient sensor, 15-30' mounting height, ambient sensor enabled at 5fc<sup>15,16</sup></p> <p>PIR1FC3V High/low, motion/ambient sensor, 8-15' mounting height, ambient sensor enabled at 1fc<sup>15,16</sup></p> <p>PIR1FC3V Bi-level, motion/ambient sensor, 15-30' mounting height, ambient sensor enabled at 1fc<sup>15,16</sup></p> <p>FAO Field adjustable output<sup>14</sup></p> <p><b>Shipped installed</b></p> <p>HS House-side shield<sup>17</sup></p> <p>SF Single fuse (120, 277, 347V)<sup>4</sup></p> <p>DF Double fuse (208, 240, 480V)<sup>4</sup></p> <p>L90 Left rotated optics<sup>1</sup></p> <p>R90 Right rotated optics<sup>1</sup></p> <p><b>Shipped separately</b></p> <p>BS Bird spikes<sup>18</sup></p> <p>EGS External glare shield<sup>18</sup></p>	<p>DDBXD Dark bronze</p> <p>DBLXD Black</p> <p>DNAXD Natural aluminum</p> <p>DWHXD White</p> <p>DBBTD Textured dark bronze</p> <p>DBLBXD Textured black</p> <p>DNATXD Textured natural aluminum</p> <p>DWHGXD Textured white</p>



## Ordering Information

### Accessories

Ordered and shipped separately.

DLL127F 1.5 JU	Photocell - SSL twist-lock (120-277V) <sup>19</sup>
DLL347F 1.5 CUL JU	Photocell - SSL twist-lock (347V) <sup>19</sup>
DLL480F 1.5 CUL JU	Photocell - SSL twist-lock (480V) <sup>19</sup>
DSHORT SBK U	Shorting cap <sup>19</sup>
DSX1HS 30C U	House-side shield for P1, P2, P3, P4 and P5 <sup>17</sup>
DSX1HS 40C U	House-side shield for P6 and P7 <sup>17</sup>
DSX1HS 60C U	House-side shield for P8, P9, P10, P11 and P12 <sup>17</sup>
PUMBA DDBXD U*	Square and round pole universal mounting bracket (specify finish) <sup>20</sup>
KMA8 DDBXD U	Mast arm mounting bracket adaptor (specify finish) <sup>6</sup>

For more control options, visit [DTL](#) and [ROAM](#) online.

### NOTES

- P10, P11, P12 or P13 and rotated optics (L90, R90) only available together.
- Not available with HS.
- MVOLT driver operates on any line voltage from 120-277V (50/60 Hz).
- Single fuse (SF) requires 120V, 277V or 347V. Double fuse (DF) requires 208V, 240V or 480V.
- Not available in P1 or P10.
- Universal mounting brackets intended for retrofit on existing, pre-drilled poles only. 1.5 G vibration load rating per ANCI C136.31.
- Must order fixture with SPA option. Must be ordered as a separate accessory; see Accessories information. For use with 2-3/8" mast arm (not included).
- Must be ordered with PIRHN. Sensor cover available only in dark bronze, black, white and natural aluminum colors.
- Must be ordered with NLTAIR2. For more information on Light Air 2 visit [this link](#).
- Photocell ordered and shipped as a separate line item from Acuity Brands Controls. See accessories. Not available with DS option. Shorting cap included.
- If ROAM® node required, it must be ordered and shipped as a separate line item from Acuity Brands Controls. Node with integral dimming.
- Provides 50/50 fixture operation via (2) independent drivers. Not available with PER, PER5, PER7, PIR or PIRH. Not available P1, P2, P3, P4 or P5.
- Requires (2) separately switched circuits with isolated neutral. See Outdoor Control Technical Guide for details.
- Reference Motion Sensor table on page 4.
- Reference controls options table on page 4 to see functionality.
- Not available with other dimming controls options
- Not available with BLC, LCCO and RCCO distribution. Also available as a separate accessory; see Accessories information.
- Must be ordered with fixture for factory pre-drilling.
- Requires luminaire to be specified with PER, PER5 or PER7 option. See PER Table on page 3.
- For retrofit use only.

## Options

### EGS - External Glare Shield

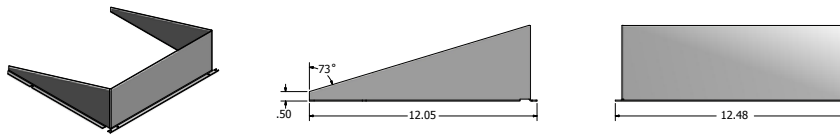

## Drilling

### HANDHOLE ORIENTATION

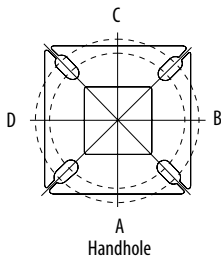

### Tenon Mounting Slipfitter\*\*

Tenon O.D.	Mounting	Single Unit	2 @ 180	2 @ 90	3 @ 120	3 @ 90	4 @ 90
2-3/8"	SPA/RPA	AS3-5 190	AS3-5 280	AS3-5 290	AS3-5 320	AS3-5 390	AS3-5 490
	SPUMBA	AS3-5 190	AS3-5 280	AS4-5 290	AS3-5 320	AS4-5 390	AS4-5 490
	RUPUMBA	AS3-5 190	AS3-5 280		AS3-5 320		
2-7/8"	SPA/RPA	AST25-190	AST25-280	AST25-290	AST25-320	AST25-390	AST25-490
	SPUMBA	AST25-190	AST25-280		AST25-320		
	RUPUMBA	AST25-190	AST25-280		AST25-320		
4"	SPA/RPA	AST35-190	AST35-280	AST35-290	AST35-320	AST35-390	AST35-490
	SPUMBA	AST35-190	AST35-280	AST35-290	AST35-320	AST35-390	AST35-490
	RUPUMBA	AST35-190	AST35-280		AST35-320		

Template #8

Top of Pole

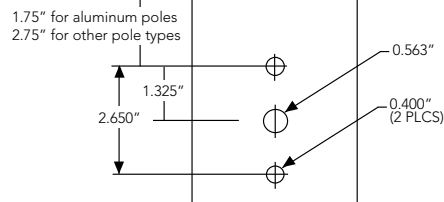

Mounting Option	Drilling Template	Single	2 @ 180	2 @ 90	3 @ 90	3 @ 120	4 @ 90
Head Location		Side B	Side B & D	Side B & C	Side B, C & D	Round Pole Only	Side A, B, C & D
Drill Nomenclature	#8	DM19AS	DM28AS	DM29AS	DM39AS	DM32AS	DM49AS

	Drilling Template	Minimum Acceptable Outside Pole Dimension					
SPA	#8	2-7/8"	2-7/8"	3.5"	3.5"	3"	3.5"
RPA	#8	2-7/8"	2-7/8"	3.5"	3.5"	3"	3.5"
SPUMBA	#5	2-7/8"	3"	4"	4"	3.5"	4"
RPUMBA	#5	2-7/8"	3.5"	5"	5"	3.5"	5"

# Photometric Diagrams

To see complete photometric reports or download .ies files for this product, visit Lithonia Lighting's [D-Series Area Size 1 homepage](#).

Isofootcandle plots for the DSX1 LED 60C 1000 40K. Distances are in units of mounting height (25').

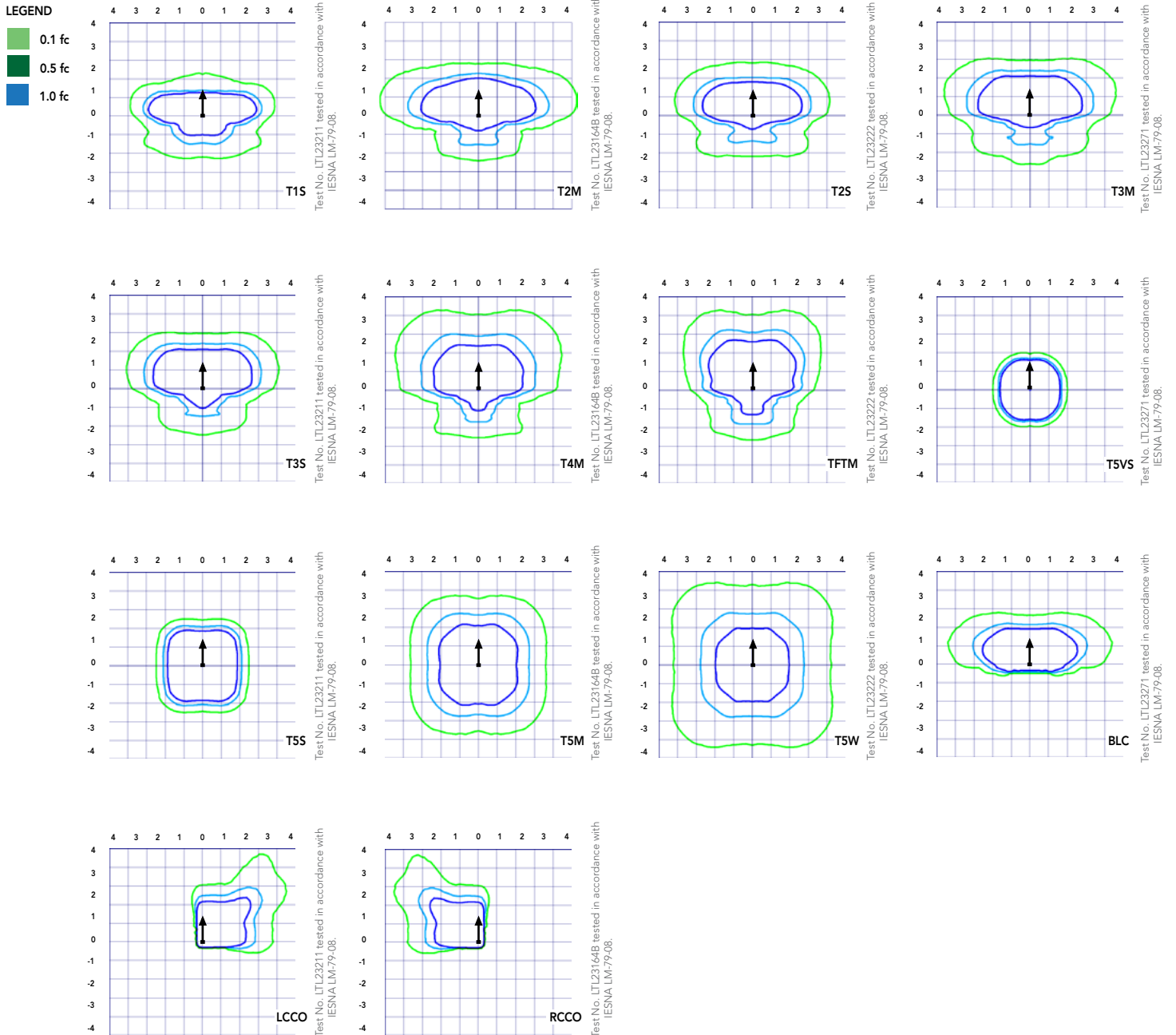



## Performance Data

### Lumen Ambient Temperature (LAT) Multipliers

Use these factors to determine relative lumen output for average ambient temperatures from 0-40°C (32-104°F).

Ambient		Lumen Multiplier
0°C	32°F	1.04
5°C	41°F	1.04
10°C	50°F	1.03
15°C	59°F	1.02
20°C	68°F	1.01
<b>25°C</b>	<b>77°F</b>	<b>1.00</b>
30°C	86°F	0.99
35°C	95°F	0.98
40°C	104°F	0.97

### Projected LED Lumen Maintenance

Data references the extrapolated performance projections for the platforms noted in a **25°C ambient**, based on 10,000 hours of LED testing (tested per IESNA LM-80-08 and projected per IESNA TM-21-11).

To calculate LLF, use the lumen maintenance factor that corresponds to the desired number of operating hours below. For other lumen maintenance values, contact factory.

Operating Hours	Lumen Maintenance Factor
0	1.00
25,000	0.96
50,000	0.92
100,000	0.85

#### Motion Sensor Default Settings

Option	Dimmed State	High Level (when triggered)	Photocell Operation	Dwell Time	Ramp-up Time	Ramp-down Time
PIR or PIRH	3V (37%) Output	10V (100%) Output	Enabled @ 5FC	5 min	3 sec	5 min
*PIR1FC3V or PIRH1FC3V	3V (37%) Output	10V (100%) Output	Enabled @ 1FC	5 min	3 sec	5 min

\*for use when motion sensor is used as dusk to dawn control.

### Electrical Load

	Performance Package	LED Count	Drive Current	Wattage	Current (A)					
					120	208	240	277	347	480
Forward Optics (Non-Rotated)	P1	30	530	54	0.45	0.26	0.23	0.19	0.10	0.12
	P2	30	700	70	0.59	0.34	0.30	0.25	0.20	0.16
	P3	30	1050	102	0.86	0.50	0.44	0.38	0.30	0.22
	P4	30	1250	125	1.06	0.60	0.52	0.46	0.37	0.27
	P5	30	1400	138	1.16	0.67	0.58	0.51	0.40	0.29
	P6	40	1250	163	1.36	0.78	0.68	0.59	0.47	0.34
	P7	40	1400	183	1.53	0.88	0.76	0.66	0.53	0.38
	P8	60	1050	207	1.74	0.98	0.87	0.76	0.64	0.49
	P9	60	1250	241	2.01	1.16	1.01	0.89	0.70	0.51
Rotated Optics (Requires L90 or R90)	P10	60	530	106	0.90	0.52	0.47	0.43	0.33	0.27
	P11	60	700	137	1.15	0.67	0.60	0.53	0.42	0.32
	P12	60	1050	207	1.74	0.99	0.87	0.76	0.60	0.46
	P13	60	1250	231	1.93	1.12	0.97	0.86	0.67	0.49

#### Controls Options

Nomenclature	Description	Functionality	Primary control device	Notes
FA0	Field adjustable output device installed inside the luminaire; wired to the driver dimming leads.	Allows the luminaire to be manually dimmed, effectively trimming the light output.	FA0 device	Cannot be used with other controls options that need the 0-10V leads
DS	Drivers wired independently for 50/50 luminaire operation	The luminaire is wired to two separate circuits, allowing for 50/50 operation.	Independently wired drivers	Requires two separately switched circuits. Consider nLight AIR as a more cost effective alternative.
PERS or PER7	Twist-lock photocell receptacle	Compatible with standard twist-lock photocells for dusk to dawn operation, or advanced control nodes that provide 0-10V dimming signals.	Twist-lock photocells such as DLL Elite or advanced control nodes such as ROAM.	Pins 4 & 5 to dimming leads on driver, Pins 6 & 7 are capped inside luminaire
PIR or PIRH	Motion sensors with integral photocell. PIR for 8-15' mounting; PIRH for 15-30' mounting	Luminaires dim when no occupancy is detected.	Acuity Controls SBOR	Also available with PIRH1FC3V when the sensor photocell is used for dusk-to-dawn operation.
NLTAIR2 PIRHN	nLight AIR enabled luminaire for motion sensing, photocell and wireless communication.	Motion and ambient light sensing with group response. Scheduled dimming with motion sensor over-ride when wirelessly connected to the nLight Eclipse.	nLight Air rSDGR	nLight AIR sensors can be programmed and commissioned from the ground using the CIAIRity Pro app.

# Performance Data

## Lumen Output

Lumen values are from photometric tests performed in accordance with IESNA LM-79-08. Data is considered to be representative of the configurations shown, within the tolerances allowed by Lighting Facts Contact factory for performance data on any configurations not shown here.

Forward Optics																			
LED Count	Drive Current	Power Package	System Watts	Dist. Type	30K (3000 K, 70 CRI)					40K (4000 K, 70 CRI)					50K (5000 K, 70 CRI)				
					Lumens	B	U	G	LPW	Lumens	B	U	G	LPW	Lumens	B	U	G	LPW
30	530	P1	54W	T1S	6,457	2	0	2	120	6,956	2	0	2	129	7,044	2	0	2	130
				T2S	6,450	2	0	2	119	6,949	2	0	2	129	7,037	2	0	2	130
				T2M	6,483	1	0	1	120	6,984	2	0	2	129	7,073	2	0	2	131
				T3S	6,279	2	0	2	116	6,764	2	0	2	125	6,850	2	0	2	127
				T3M	6,468	1	0	2	120	6,967	1	0	2	129	7,056	1	0	2	131
				T4M	6,327	1	0	2	117	6,816	1	0	2	126	6,902	1	0	2	128
				TFTM	6,464	1	0	2	120	6,963	1	0	2	129	7,051	1	0	2	131
				TSVS	6,722	2	0	0	124	7,242	3	0	0	134	7,334	3	0	0	136
				T5S	6,728	2	0	1	125	7,248	2	0	1	134	7,340	2	0	1	136
				T5M	6,711	3	0	1	124	7,229	3	0	1	134	7,321	3	0	2	136
				TSW	6,667	3	0	2	123	7,182	3	0	2	133	7,273	3	0	2	135
				BLC	5,299	1	0	1	98	5,709	1	0	2	106	5,781	1	0	2	107
				LCCO	3,943	1	0	2	73	4,248	1	0	2	79	4,302	1	0	2	80
				RCCO	3,943	1	0	2	73	4,248	1	0	2	79	4,302	1	0	2	80
30	700	P2	70W	T1S	8,249	2	0	2	118	8,886	2	0	2	127	8,999	2	0	2	129
				T2S	8,240	2	0	2	118	8,877	2	0	2	127	8,989	2	0	2	128
				T2M	8,283	2	0	2	118	8,923	2	0	2	127	9,036	2	0	2	129
				T3S	8,021	2	0	2	115	8,641	2	0	2	123	8,751	2	0	2	125
				T3M	8,263	2	0	2	118	8,901	2	0	2	127	9,014	2	0	2	129
				T4M	8,083	2	0	2	115	8,708	2	0	2	124	8,818	2	0	2	126
				TFTM	8,257	2	0	2	118	8,896	2	0	2	127	9,008	2	0	2	129
				TSVS	8,588	3	0	0	123	9,252	3	0	0	132	9,369	3	0	0	134
				T5S	8,595	3	0	1	123	9,259	3	0	1	132	9,376	3	0	1	134
				T5M	8,573	3	0	2	122	9,236	3	0	2	132	9,353	3	0	2	134
				TSW	8,517	3	0	2	122	9,175	4	0	2	131	9,291	4	0	2	133
				BLC	6,770	1	0	2	97	7,293	1	0	2	104	7,386	1	0	2	106
				LCCO	5,038	1	0	2	72	5,427	1	0	2	78	5,496	1	0	2	79
				RCCO	5,038	1	0	2	72	5,427	1	0	2	78	5,496	1	0	2	79
30	1050	P3	102W	T1S	11,661	2	0	2	114	12,562	3	0	3	123	12,721	3	0	3	125
				T2S	11,648	2	0	2	114	12,548	3	0	3	123	12,707	3	0	3	125
				T2M	11,708	2	0	2	115	12,613	2	0	2	124	12,773	2	0	2	125
				T3S	11,339	2	0	2	111	12,215	3	0	3	120	12,370	3	0	3	121
				T3M	11,680	2	0	2	115	12,582	2	0	2	123	12,742	2	0	2	125
				T4M	11,426	2	0	3	112	12,309	2	0	3	121	12,465	2	0	3	122
				TFTM	11,673	2	0	2	114	12,575	2	0	3	123	12,734	2	0	3	125
				TSVS	12,140	3	0	1	119	13,078	3	0	1	128	13,244	3	0	1	130
				T5S	12,150	3	0	1	119	13,089	3	0	1	128	13,254	3	0	1	130
				T5M	12,119	4	0	2	119	13,056	4	0	2	128	13,221	4	0	2	130
				TSW	12,040	4	0	3	118	12,970	4	0	3	127	13,134	4	0	3	129
				BLC	9,570	1	0	2	94	10,310	1	0	2	101	10,440	1	0	2	102
				LCCO	7,121	1	0	3	70	7,671	1	0	3	75	7,768	1	0	3	76
				RCCO	7,121	1	0	3	70	7,671	1	0	3	75	7,768	1	0	3	76
30	1250	P4	125W	T1S	13,435	3	0	3	107	14,473	3	0	3	116	14,657	3	0	3	117
				T2S	13,421	3	0	3	107	14,458	3	0	3	116	14,641	3	0	3	117
				T2M	13,490	2	0	2	108	14,532	3	0	3	116	14,716	3	0	3	118
				T3S	13,064	3	0	3	105	14,074	3	0	3	113	14,252	3	0	3	114
				T3M	13,457	2	0	2	108	14,497	2	0	2	116	14,681	2	0	2	117
				T4M	13,165	2	0	3	105	14,182	2	0	3	113	14,362	2	0	3	115
				TFTM	13,449	2	0	3	108	14,488	2	0	3	116	14,672	2	0	3	117
				TSVS	13,987	4	0	1	112	15,068	4	0	1	121	15,259	4	0	1	122
				T5S	13,999	3	0	1	112	15,080	3	0	1	121	15,271	3	0	1	122
				T5M	13,963	4	0	2	112	15,042	4	0	2	120	15,233	4	0	2	122
				TSW	13,872	4	0	3	111	14,944	4	0	3	120	15,133	4	0	3	121
				BLC	11,027	1	0	2	88	11,879	1	0	2	95	12,029	1	0	2	96
				LCCO	8,205	1	0	3	66	8,839	1	0	3	71	8,951	1	0	3	72
				RCCO	8,205	1	0	3	66	8,839	1	0	3	71	8,951	1	0	3	72
30	1400	P5	138W	T1S	14,679	3	0	3	106	15,814	3	0	3	115	16,014	3	0	3	116
				T2S	14,664	3	0	3	106	15,797	3	0	3	114	15,997	3	0	3	116
				T2M	14,739	3	0	3	107	15,878	3	0	3	115	16,079	3	0	3	117
				T3S	14,274	3	0	3	103	15,377	3	0	3	111	15,572	3	0	3	113
				T3M	14,704	2	0	3	107	15,840	3	0	3	115	16,040	3	0	3	116
				T4M	14,384	2	0	3	104	15,496	3	0	3	112	15,692	3	0	3	114
				TFTM	14,695	2	0	3	106	15,830	3	0	3	115	16,030	3	0	3	116
				TSVS	15,283	4	0	1	111	16,464	4	0	1	119	16,672	4	0	1	121
				T5S	15,295	3	0	1	111	16,477	4	0	1	119	16,686	4	0	1	121
				T5M	15,257	4	0	2	111	16,435	4	0	2	119	16,644	4	0	2	121
				TSW	15,157	4	0	3	110	16,328	4	0	3	118	16,534	4	0	3	120
				BLC	12,048	1	0	2	87	12,979	1	0	2	94	13,143	1	0	2	95
				LCCO	8,965	1	0	3	65	9,657	1	0	3	70	9,780	1	0	3	71
				RCCO	8,965	1	0	3	65	9,657	1	0	3	70	9,780	1	0	3	71



# Performance Data

## Lumen Output

Lumen values are from photometric tests performed in accordance with IESNA LM-79-08. Data is considered to be representative of the configurations shown, within the tolerances allowed by Lighting Facts. Contact factory for performance data on any configurations not shown here.

Forward Optics																			
LED Count	Drive Current	Power Package	System Watts	Dist. Type	30K (3000 K, 70 CRI)					40K (4000 K, 70 CRI)					50K (5000 K, 70 CRI)				
					Lumens	B	U	G	LPW	Lumens	B	U	G	LPW	Lumens	B	U	G	LPW
40	1250	P6	163W	T1S	17,654	3	0	3	108	19,018	3	0	3	117	19,259	3	0	3	118
				T2S	17,635	3	0	3	108	18,998	3	0	3	117	19,238	3	0	3	118
				T2M	17,726	3	0	3	109	19,096	3	0	3	117	19,337	3	0	3	119
				T3S	17,167	3	0	3	105	18,493	3	0	3	113	18,727	3	0	3	115
				T3M	17,683	3	0	3	108	19,049	3	0	3	117	19,290	3	0	3	118
				T4M	17,299	3	0	3	106	18,635	3	0	4	114	18,871	3	0	4	116
				TFTM	17,672	3	0	3	108	19,038	3	0	4	117	19,279	3	0	4	118
				TSVS	18,379	4	0	1	113	19,800	4	0	1	121	20,050	4	0	1	123
				T5S	18,394	4	0	2	113	19,816	4	0	2	122	20,066	4	0	2	123
				T5M	18,348	4	0	2	113	19,766	4	0	2	121	20,016	4	0	2	123
				TSW	18,228	5	0	3	112	19,636	5	0	3	120	19,885	5	0	3	122
				BLC	14,489	2	0	2	89	15,609	2	0	3	96	15,806	2	0	3	97
				LCCO	10,781	1	0	3	66	11,614	1	0	3	71	11,761	2	0	3	72
				RCCO	10,781	1	0	3	66	11,614	1	0	3	71	11,761	2	0	3	72
40	1400	P7	183W	T1S	19,227	3	0	3	105	20,712	3	0	3	113	20,975	3	0	3	115
				T2S	19,206	3	0	3	105	20,690	3	0	3	113	20,952	3	0	3	114
				T2M	19,305	3	0	3	105	20,797	3	0	3	114	21,060	3	0	3	115
				T3S	18,696	3	0	3	102	20,141	3	0	3	110	20,396	3	0	4	111
				T3M	19,258	3	0	3	105	20,746	3	0	3	113	21,009	3	0	3	115
				T4M	18,840	3	0	4	103	20,296	3	0	4	111	20,553	3	0	4	112
				TFTM	19,246	3	0	4	105	20,734	3	0	4	113	20,996	3	0	4	115
				TSVS	20,017	4	0	1	109	21,564	4	0	1	118	21,837	4	0	1	119
				T5S	20,033	4	0	2	109	21,581	4	0	2	118	21,854	4	0	2	119
				T5M	19,983	4	0	2	109	21,527	5	0	3	118	21,799	5	0	3	119
				TSW	19,852	5	0	3	108	21,386	5	0	3	117	21,656	5	0	3	118
				BLC	15,780	2	0	3	86	16,999	2	0	3	93	17,214	2	0	3	94
				LCCO	11,742	2	0	3	64	12,649	2	0	3	69	12,809	2	0	3	70
				RCCO	11,742	2	0	3	64	12,649	2	0	3	69	12,809	2	0	3	70
60	1050	P8	207W	T1S	22,490	3	0	3	109	24,228	3	0	3	117	24,535	3	0	3	119
				T2S	22,466	3	0	4	109	24,202	3	0	4	117	24,509	3	0	4	118
				T2M	22,582	3	0	3	109	24,327	3	0	3	118	24,635	3	0	3	119
				T3S	21,870	3	0	4	106	23,560	3	0	4	114	23,858	3	0	4	115
				T3M	22,527	3	0	4	109	24,268	3	0	4	117	24,575	3	0	4	119
				T4M	22,038	3	0	4	106	23,741	3	0	4	115	24,041	3	0	4	116
				TFTM	22,513	3	0	4	109	24,253	3	0	4	117	24,560	3	0	4	119
				TSVS	23,415	5	0	1	113	25,224	5	0	1	122	25,543	5	0	1	123
				T5S	23,434	4	0	2	113	25,244	4	0	2	122	25,564	4	0	2	123
				T5M	23,374	5	0	3	113	25,181	5	0	3	122	25,499	5	0	3	123
				TSW	23,221	5	0	4	112	25,016	5	0	4	121	25,332	5	0	4	122
				BLC	18,458	2	0	3	89	19,885	2	0	3	96	20,136	2	0	3	97
				LCCO	13,735	2	0	3	66	14,796	2	0	4	71	14,983	2	0	4	72
				RCCO	13,735	2	0	3	66	14,796	2	0	4	71	14,983	2	0	4	72
60	1250	P9	241W	T1S	25,575	3	0	3	106	27,551	3	0	3	114	27,900	3	0	3	116
				T2S	25,548	3	0	4	106	27,522	3	0	4	114	27,871	3	0	4	116
				T2M	25,680	3	0	3	107	27,664	3	0	3	115	28,014	3	0	3	116
				T3S	24,870	3	0	4	103	26,791	3	0	4	111	27,130	3	0	4	113
				T3M	25,617	3	0	4	106	27,597	3	0	4	115	27,946	3	0	4	116
				T4M	25,061	3	0	4	104	26,997	3	0	4	112	27,339	3	0	4	113
				TFTM	25,602	3	0	4	106	27,580	3	0	4	114	27,929	3	0	4	116
				TSVS	26,626	5	0	1	110	28,684	5	0	1	119	29,047	5	0	1	121
				T5S	26,648	4	0	2	111	28,707	5	0	2	119	29,070	5	0	2	121
				T5M	26,581	5	0	3	110	28,635	5	0	3	119	28,997	5	0	3	120
				TSW	26,406	5	0	4	110	28,447	5	0	4	118	28,807	5	0	4	120
				BLC	20,990	2	0	3	87	22,612	2	0	3	94	22,898	2	0	3	95
				LCCO	15,619	2	0	4	65	16,825	2	0	4	70	17,038	2	0	4	71
				RCCO	15,619	2	0	4	65	16,825	2	0	4	70	17,038	2	0	4	71

# Performance Data

## Lumen Output

Lumen values are from photometric tests performed in accordance with IESNA LM-79-08. Data is considered to be representative of the configurations shown, within the tolerances allowed by Lighting Facts. Contact factory for performance data on any configurations not shown here.

Rotated Optics																			
LED Count	Drive Current	Power Package	System Watts	Dist. Type	30K (3000 K, 70 CRI)					40K (4000 K, 70 CRI)					50K (5000 K, 70 CRI)				
					Lumens	B	U	G	LPW	Lumens	B	U	G	LPW	Lumens	B	U	G	LPW
60	530	P10	106W	T1S	13,042	3	0	3	123	14,050	3	0	3	133	14,228	3	0	3	134
				T2S	12,967	4	0	4	122	13,969	4	0	4	132	14,146	4	0	4	133
				T2M	13,201	3	0	3	125	14,221	3	0	3	134	14,401	3	0	3	136
				T3S	12,766	4	0	4	120	13,752	4	0	4	130	13,926	4	0	4	131
				T3M	13,193	4	0	4	124	14,213	4	0	4	134	14,393	4	0	4	136
				T4M	12,944	4	0	4	122	13,945	4	0	4	132	14,121	4	0	4	133
				TFTM	13,279	4	0	4	125	14,305	4	0	4	135	14,486	4	0	4	137
				TSVS	13,372	3	0	1	126	14,405	4	0	1	136	14,588	4	0	1	138
				T5S	13,260	3	0	1	125	14,284	3	0	1	135	14,465	3	0	1	136
				T5M	13,256	4	0	2	125	14,281	4	0	2	135	14,462	4	0	2	136
				TSW	13,137	4	0	3	124	14,153	4	0	3	134	14,332	4	0	3	135
				BLC	10,906	3	0	3	103	11,749	3	0	3	111	11,898	3	0	3	112
				LCCO	7,789	1	0	3	73	8,391	1	0	3	79	8,497	1	0	3	80
				RCCO	7,779	4	0	4	73	8,380	4	0	4	79	8,486	4	0	4	80
60	700	P11	137W	T1S	16,556	3	0	3	121	17,835	3	0	3	130	18,061	4	0	4	132
				T2S	16,461	4	0	4	120	17,733	4	0	4	129	17,957	4	0	4	131
				T2M	16,758	4	0	4	122	18,053	4	0	4	132	18,281	4	0	4	133
				T3S	16,205	4	0	4	118	17,457	4	0	4	127	17,678	4	0	4	129
				T3M	16,748	4	0	4	122	18,042	4	0	4	132	18,271	4	0	4	133
				T4M	16,432	4	0	4	120	17,702	4	0	4	129	17,926	4	0	4	131
				TFTM	16,857	4	0	4	123	18,159	4	0	4	133	18,389	4	0	4	134
				TSVS	16,975	4	0	1	124	18,287	4	0	1	133	18,518	4	0	1	135
				T5S	16,832	4	0	1	123	18,133	4	0	2	132	18,362	4	0	2	134
				T5M	16,828	4	0	2	123	18,128	4	0	2	132	18,358	4	0	2	134
				TSW	16,677	4	0	3	122	17,966	5	0	3	131	18,193	5	0	3	133
				BLC	13,845	3	0	3	101	14,915	3	0	3	109	15,103	3	0	3	110
				LCCO	9,888	1	0	3	72	10,652	2	0	3	78	10,787	2	0	3	79
				RCCO	9,875	4	0	4	72	10,638	4	0	4	78	10,773	4	0	4	79
60	1050	P12	207W	T1S	22,996	4	0	4	111	24,773	4	0	4	120	25,087	4	0	4	121
				T2S	22,864	4	0	4	110	24,631	5	0	5	119	24,943	5	0	5	120
				T2M	23,277	4	0	4	112	25,075	4	0	4	121	25,393	4	0	4	123
				T3S	22,509	4	0	4	109	24,248	5	0	5	117	24,555	5	0	5	119
				T3M	23,263	4	0	4	112	25,061	4	0	4	121	25,378	4	0	4	123
				T4M	22,824	5	0	5	110	24,588	5	0	5	119	24,899	5	0	5	120
				TFTM	23,414	5	0	5	113	25,223	5	0	5	122	25,543	5	0	5	123
				TSVS	23,579	5	0	1	114	25,401	5	0	1	123	25,722	5	0	1	124
				T5S	23,380	4	0	2	113	25,187	4	0	2	122	25,506	4	0	2	123
				T5M	23,374	5	0	3	113	25,181	5	0	3	122	25,499	5	0	3	123
				TSW	23,165	5	0	4	112	24,955	5	0	4	121	25,271	5	0	4	122
				BLC	19,231	4	0	4	93	20,717	4	0	4	100	20,979	4	0	4	101
				LCCO	13,734	2	0	3	66	14,796	2	0	4	71	14,983	2	0	4	72
				RCCO	13,716	4	0	4	66	14,776	4	0	4	71	14,963	4	0	4	72
60	1250	P13	231W	T1S	25,400	4	0	4	110	27,363	4	0	4	118	27,709	4	0	4	120
				T2S	25,254	5	0	5	109	27,205	5	0	5	118	27,550	5	0	5	119
				T2M	25,710	4	0	4	111	27,696	4	0	4	120	28,047	4	0	4	121
				T3S	24,862	5	0	5	108	26,783	5	0	5	116	27,122	5	0	5	117
				T3M	25,695	5	0	5	111	27,680	5	0	5	120	28,031	5	0	5	121
				T4M	25,210	5	0	5	109	27,158	5	0	5	118	27,502	5	0	5	119
				TFTM	25,861	5	0	5	112	27,860	5	0	5	121	28,212	5	0	5	122
				TSVS	26,043	5	0	1	113	28,056	5	0	1	121	28,411	5	0	1	123
				T5S	25,824	4	0	2	112	27,819	5	0	2	120	28,172	5	0	2	122
				T5M	25,818	5	0	3	112	27,813	5	0	3	120	28,165	5	0	3	122
				TSW	25,586	5	0	4	111	27,563	5	0	4	119	27,912	5	0	4	121
				BLC	21,241	4	0	4	92	22,882	4	0	4	99	23,172	4	0	4	100
				LCCO	15,170	2	0	4	66	16,342	2	0	4	71	16,549	2	0	4	72
				RCCO	15,150	5	0	5	66	16,321	5	0	5	71	16,527	5	0	5	72

## Capable Luminaire

This item is an A+ capable luminaire, which has been designed and tested to provide consistent color appearance and system-level interoperability.

- All configurations of this luminaire meet the Acuity Brands' specification for chromatic consistency
- This luminaire is A+ Certified when ordered with DTL® controls marked by a shaded background. DTL DLL equipped luminaires meet the A+ specification for luminaire to photocontrol interoperability<sup>1</sup>
- This luminaire is part of an A+ Certified solution for ROAM® or XPoint™ Wireless control networks, providing out-of-the-box control compatibility with simple commissioning, when ordered with drivers and control options marked by a shaded background<sup>1</sup>

To learn more about A+, visit [www.acuitybrands.com/aplus](http://www.acuitybrands.com/aplus).

1. See ordering tree for details.
2. A+ Certified Solutions for ROAM require the order of one ROAM node per luminaire. Sold Separately: [Link to Roam](#); [Link to DTL DLL](#)

## FEATURES & SPECIFICATIONS

### INTENDED USE

The sleek design of the D-Series Size 1 reflects the embedded high performance LED technology. It is ideal for many commercial and municipal applications, such as parking lots, plazas, campuses, and streetscapes.

### CONSTRUCTION

Single-piece die-cast aluminum housing has integral heat sink fins to optimize thermal management through conductive and convective cooling. Modular design allows for ease of maintenance and future light engine upgrades. The LED drivers are mounted in direct contact with the casting to promote low operating temperature and long life. Housing is completely sealed against moisture and environmental contaminants (IP65). Low EPA (1.01 ft<sup>2</sup>) for optimized pole wind loading.

### FINISH

Exterior parts are protected by a zinc-infused Super Durable TGIC thermoset powder coat finish that provides superior resistance to corrosion and weathering. A tightly controlled multi-stage process ensures a minimum 3 mils thickness for a finish that can withstand extreme climate changes without cracking or peeling. Available in both textured and non-textured finishes.

### OPTICS

Precision-molded proprietary acrylic lenses are engineered for superior area lighting distribution, uniformity, and pole spacing. Light engines are available in standard 3000 K, 4000 K and 5000 K (70 CRI) configurations. The D-Series Size 1 has zero uplight and qualifies as a Nighttime Friendly™ product, meaning it is consistent with the LEED® and Green Globes™ criteria for eliminating wasteful uplight.

### ELECTRICAL

Light engine configurations consist of high-efficacy LEDs mounted to metal-core circuit boards to maximize heat dissipation and promote long life (up to L85/100,000 hours at 25°C). Class 1 electronic drivers are designed to have a power factor >90%, THD <20%, and an expected life of 100,000 hours with <1% failure rate. Easily serviceable 10kV surge protection device meets a minimum Category C Low operation (per ANSI/IEEE C62.41.2).

### STANDARD CONTROLS

The DSX1 LED area luminaire has a number of control options. Dusk to dawn controls can be utilized via optional NEMA twist-lock photocell receptacles. Integrated motion sensors with on-board photocells feature field-adjustable programming and are suitable for mounting heights up to 30 feet.

### nLIGHT AIR CONTROLS

The DSX1 LED area luminaire is also available with nLight® AIR for the ultimate in wireless control. This powerful controls platform provides out-of-the-box basic motion sensing and photocontrol functionality and is suitable for mounting heights up to 40 feet. Once commissioned using a smartphone and the easy-to-use CLAIRITY app, nLight AIR equipped luminaires can be grouped, resulting in motion sensor and photocell group response without the need for additional equipment. Scheduled dimming with motion sensor over-ride can be achieved when used with the nLight Eclipse. Additional information about nLight Air can be found here.

### INSTALLATION

Included mounting block and integral arm facilitate quick and easy installation. Stainless steel bolts fasten the mounting block securely to poles and walls, enabling the D-Series Size 1 to withstand up to a 3.0 G vibration load rating per ANSI C136.31. The D-Series Size 1 utilizes the AERIS™ series pole drilling pattern (template #8). NEMA photocontrol receptacle are also available.

### LISTINGS

UL Listed for wet locations. Light engines are IP66 rated; luminaire is IP65 rated. Rated for -40°C minimum ambient. U.S. Patent No. D672,492 S. International patent pending.

DesignLights Consortium® (DLC) Premium qualified product and DLC qualified product.

Not all versions of this product may be DLC Premium qualified or DLC qualified. Please check the DLC Qualified Products List at [www.designlights.org/QPL](http://www.designlights.org/QPL) to confirm which versions are qualified.

International Dark-Sky Association (IDA) Fixture Seal of Approval (FSA) is available for all products on this page utilizing 3000K color temperature only.

### WARRANTY

5-year limited warranty. Complete warranty terms located at: [www.acuitybrands.com/CustomResources/Terms\\_and\\_conditions.aspx](http://www.acuitybrands.com/CustomResources/Terms_and_conditions.aspx)

**Note:** Actual performance may differ as a result of end-user environment and application.

All values are design or typical values, measured under laboratory conditions at 25 °C.

Specifications subject to change without notice.





# D-Series Size 1 LED Area Luminaire

d#series



Catalog Number
Notes
Type

Hit the Tab key or mouse over the page to see all interactive elements.

## Specifications

<b>EPA:</b>	1.01 ft <sup>2</sup> (0.09 m <sup>2</sup> )
<b>Length:</b>	33" (83.8 cm)
<b>Width:</b>	13" (33.0 cm)
<b>Height H1:</b>	7-1/2" (19.0 cm)
<b>Height H2:</b>	3-1/2"
<b>Weight (max):</b>	27 lbs (12.2 kg)

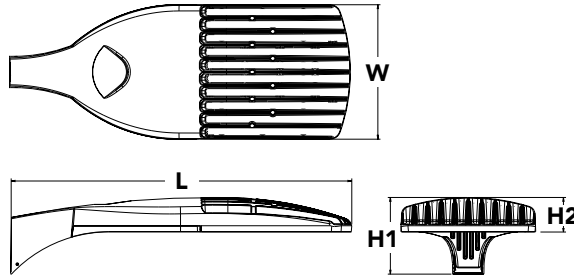

## Introduction

The modern styling of the D-Series is striking yet unobtrusive - making a bold, progressive statement even as it blends seamlessly with its environment. The D-Series distills the benefits of the latest in LED technology into a high performance, high efficacy, long-life luminaire.

The outstanding photometric performance results in sites with excellent uniformity, greater pole spacing and lower power density. It is ideal for replacing up to 750W metal halide in pedestrian and area lighting applications with typical energy savings of 65% and expected service life of over 100,000 hours.

A+ Capable options indicated by this color background.

## Ordering Information

**EXAMPLE:** DSX1 LED P7 40K T3M MVOLT SPA NLTAIR2 PIRHN DDBXD

DSX1 LED		Color temperature		Distribution		Voltage	Mounting		
Series	LEDs								
<b>DSX1 LED</b>	<b>Forward optics</b>	30K	3000 K	T1S	Type I short	T5VS	Type V very short	<b>MVOLT<sup>3</sup></b>	<b>Shipped included</b>
	P1 <b>P4</b> P7	40K	4000 K	T2S	Type II short	T5S	Type V short	120 <sup>4</sup>	SPA Square pole mounting
	P2 P5 P8	<b>50K</b>	<b>5000 K</b>	T2M	Type II medium	T5M	Type V medium	208 <sup>4</sup>	RPA Round pole mounting
	P3 P6 P9			T3S	Type III short	T5W	Type V wide	240 <sup>4</sup>	<b>WBA</b> <b>Wall bracket</b>
	<b>Rotated optics</b>			T3M	Type III medium	BLC	Backlight control <sup>2</sup>	277 <sup>4</sup>	SPUMBA Square pole universal mounting adaptor <sup>6</sup>
	P10 <sup>1</sup> P12 <sup>1</sup>			T4M	Type IV medium	LCCO	Left corner cutoff <sup>2</sup>	347 <sup>4,5</sup>	RPUMBA Round pole universal mounting adaptor <sup>6</sup>
	P11 <sup>1</sup> P13 <sup>1</sup>			<b>TFTM</b>	Forward throw medium	RCCO	Right corner cutoff <sup>2</sup>	480 <sup>4,5</sup>	<b>Shipped separately</b>
									KMA8 DDBXD U Mast arm mounting bracket adaptor (specify finish) <sup>7</sup>

Control options	Other options	Finish (required)
<b>Shipped installed</b> NLTAIR2 nLight AIR generation 2 enabled <sup>8</sup> PIRHN Network, high/low motion/ambient sensor <sup>9</sup> PER NEMA twist-lock receptacle only (controls ordered separate) <sup>10</sup> PER5 Five-pin receptacle only (controls ordered separate) <sup>10,11</sup> PER7 Seven-pin receptacle only (controls ordered separate) <sup>10,11</sup> DMG 0-10v dimming wires pulled outside fixture (for use with an external control, ordered separately) <sup>12</sup> DS Dual switching <sup>12,13,14</sup>	PIR High/low, motion/ambient sensor, 8-15' mounting height, ambient sensor enabled at 5fc <sup>15,16</sup> PIRH High/low, motion/ambient sensor, 15-30' mounting height, ambient sensor enabled at 5fc <sup>15,16</sup> PIR1FC3V High/low, motion/ambient sensor, 8-15' mounting height, ambient sensor enabled at 1fc <sup>15,16</sup> PIRH1FC3V Bi-level, motion/ambient sensor, 15-30' mounting height, ambient sensor enabled at 1fc <sup>15,16</sup> FAO Field adjustable output <sup>14</sup>	<b>Shipped installed</b> HS House-side shield <sup>17</sup> SF Single fuse (120, 277, 347V) <sup>4</sup> DF Double fuse (208, 240, 480V) <sup>4</sup> L90 Left rotated optics <sup>1</sup> R90 Right rotated optics <sup>1</sup> <b>Shipped separately</b> BS Bird spikes <sup>18</sup> EGS External glare shield <sup>18</sup>
		DDBXD Dark bronze DBLXD Black DNAXD Natural aluminum DWHXD White DDBTXD Textured dark bronze DBLBXD Textured black DNATXD Textured natural aluminum DWHGXD Textured white



## Ordering Information

### Accessories

Ordered and shipped separately.

DLL127F 1.5 JU	Photocell - SSL twist-lock (120-277V) <sup>19</sup>
DLL347F 1.5 CUL JU	Photocell - SSL twist-lock (347V) <sup>19</sup>
DLL480F 1.5 CUL JU	Photocell - SSL twist-lock (480V) <sup>19</sup>
DSHORT SBK U	Shorting cap <sup>19</sup>
DSX1HS 30C U	House-side shield for P1, P2, P3, P4 and P5 <sup>17</sup>
DSX1HS 40C U	House-side shield for P6 and P7 <sup>17</sup>
DSX1HS 60C U	House-side shield for P8, P9, P10, P11 and P12 <sup>17</sup>
PUMBA DDBXD U*	Square and round pole universal mounting bracket (specify finish) <sup>20</sup>
KMA8 DDBXD U	Mast arm mounting bracket adaptor (specify finish) <sup>6</sup>

For more control options, visit [DTL](#) and [ROAM](#) online.

### NOTES

- P10, P11, P12 or P13 and rotated optics (L90, R90) only available together.
- Not available with HS.
- MVOLT driver operates on any line voltage from 120-277V (50/60 Hz).
- Single fuse (SF) requires 120V, 277V or 347V. Double fuse (DF) requires 208V, 240V or 480V.
- Not available in P1 or P10.
- Universal mounting brackets intended for retrofit on existing, pre-drilled poles only. 1.5 G vibration load rating per ANCI C136.31.
- Must order fixture with SPA option. Must be ordered as a separate accessory; see Accessories information. For use with 2-3/8" mast arm (not included).
- Must be ordered with PIRHN. Sensor cover available only in dark bronze, black, white and natural aluminum colors.
- Must be ordered with NLTAIR2. For more information on Light Air 2 visit [this link](#).
- Photocell ordered and shipped as a separate line item from Acuity Brands Controls. See accessories. Not available with DS option. Shorting cap included.
- If ROAM® node required, it must be ordered and shipped as a separate line item from Acuity Brands Controls. Node with integral dimming.
- Provides 50/50 fixture operation via (2) independent drivers. Not available with PER, PER5, PER7, PIR or PIRH. Not available P1, P2, P3, P4 or P5.
- Requires (2) separately switched circuits with isolated neutral. See Outdoor Control Technical Guide for details.
- Reference Motion Sensor table on page 4.
- Reference controls options table on page 4 to see functionality.
- Not available with other dimming controls options
- Not available with BLC, LCCO and RCCO distribution. Also available as a separate accessory; see Accessories information.
- Must be ordered with fixture for factory pre-drilling.
- Requires luminaire to be specified with PER, PER5 or PER7 option. See PER Table on page 3.
- For retrofit use only.

## Options

### EGS - External Glare Shield

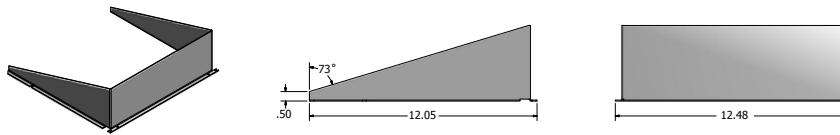

## Drilling

### HANDHOLE ORIENTATION

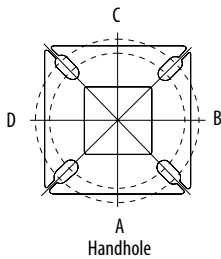

### Tenon Mounting Slipfitter\*\*

Tenon O.D.	Mounting	Single Unit	2 @ 180	2 @ 90	3 @ 120	3 @ 90	4 @ 90
2-3/8"	SPA/RPA	AS3-5 190	AS3-5 280	AS3-5 290	AS3-5 320	AS3-5 390	AS3-5 490
	SPUMBA	AS3-5 190	AS3-5 280	AS4-5 290	AS3-5 320	AS4-5 390	AS4-5 490
	RUPUMBA	AS3-5 190	AS3-5 280		AS3-5 320		
2-7/8"	SPA/RPA	AST25-190	AST25-280	AST25-290	AST25-320	AST25-390	AST25-490
	SPUMBA	AST25-190	AST25-280		AST25-320		
	RUPUMBA	AST25-190	AST25-280		AST25-320		
4"	SPA/RPA	AST35-190	AST35-280	AST35-290	AST35-320	AST35-390	AST35-490
	SPUMBA	AST35-190	AST35-280	AST35-290	AST35-320	AST35-390	AST35-490
	RUPUMBA	AST35-190	AST35-280		AST35-320		

Template #8

Top of Pole

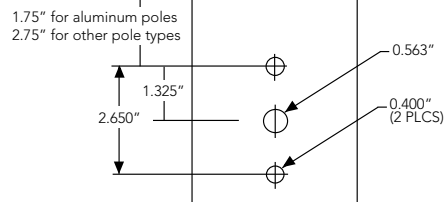

Mounting Option	Drilling Template	Single	2 @ 180	2 @ 90	3 @ 90	3 @ 120	4 @ 90
Head Location		Side B	Side B & D	Side B & C	Side B, C & D	Round Pole Only	Side A, B, C & D
Drill Nomenclature	#8	DM19AS	DM28AS	DM29AS	DM39AS	DM32AS	DM49AS

	Drilling Template	Minimum Acceptable Outside Pole Dimension					
SPA	#8	2-7/8"	2-7/8"	3.5"	3.5"	3"	3.5"
RPA	#8	2-7/8"	2-7/8"	3.5"	3.5"	3"	3.5"
SPUMBA	#5	2-7/8"	3"	4"	4"	3.5"	4"
RPUMBA	#5	2-7/8"	3.5"	5"	5"	3.5"	5"



# Photometric Diagrams

To see complete photometric reports or download .ies files for this product, visit Lithonia Lighting's [D-Series Area Size 1 homepage](#).

Isofootcandle plots for the DSX1 LED 60C 1000 40K. Distances are in units of mounting height (25').

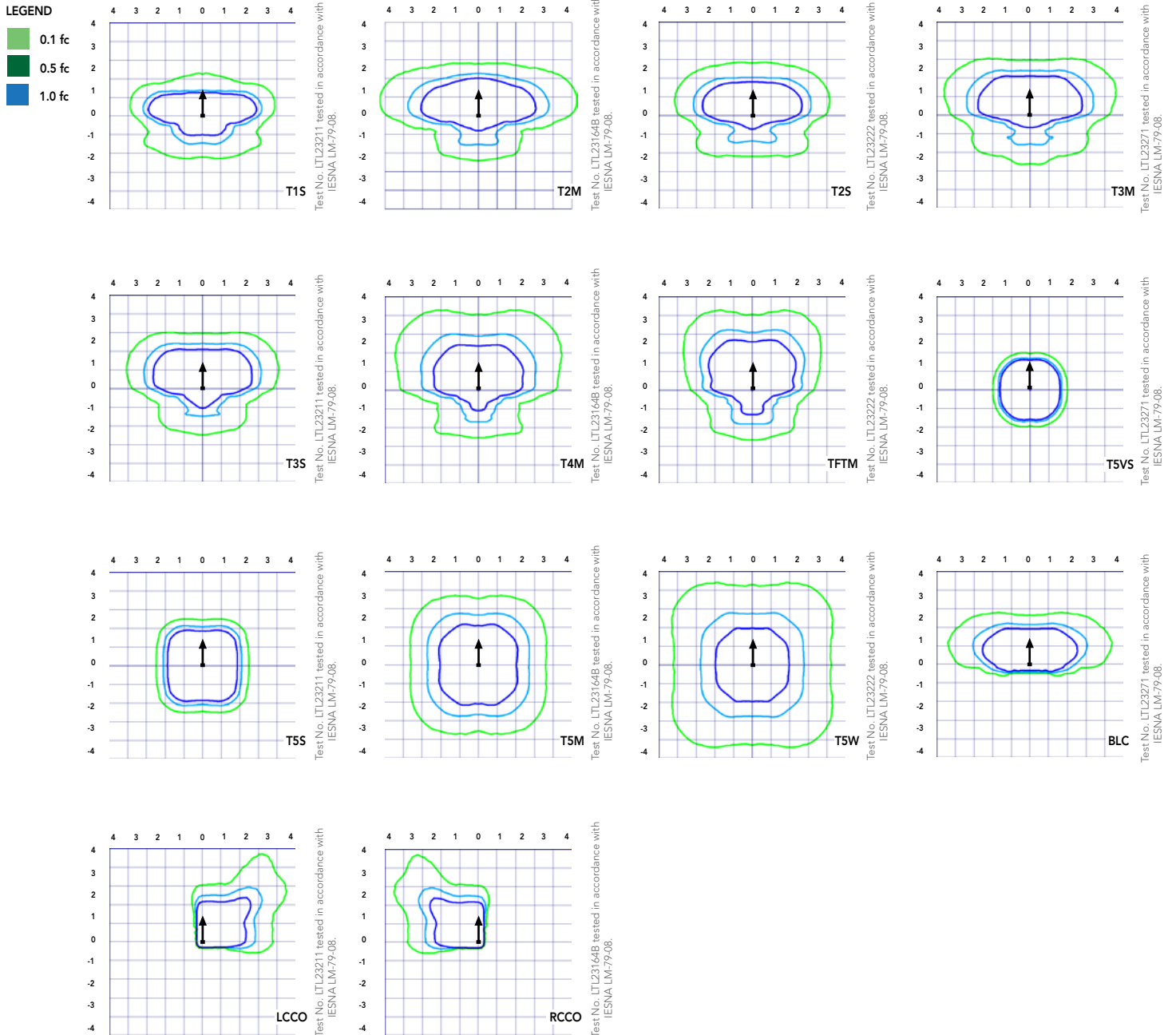

## Performance Data

### Lumen Ambient Temperature (LAT) Multipliers

Use these factors to determine relative lumen output for average ambient temperatures from 0-40°C (32-104°F).

Ambient		Lumen Multiplier
0°C	32°F	1.04
5°C	41°F	1.04
10°C	50°F	1.03
15°C	59°F	1.02
20°C	68°F	1.01
<b>25°C</b>	<b>77°F</b>	<b>1.00</b>
30°C	86°F	0.99
35°C	95°F	0.98
40°C	104°F	0.97

### Projected LED Lumen Maintenance

Data references the extrapolated performance projections for the platforms noted in a **25°C ambient**, based on 10,000 hours of LED testing (tested per IESNA LM-80-08 and projected per IESNA TM-21-11).

To calculate LLF, use the lumen maintenance factor that corresponds to the desired number of operating hours below. For other lumen maintenance values, contact factory.

Operating Hours	Lumen Maintenance Factor
0	1.00
25,000	0.96
50,000	0.92
100,000	0.85

#### Motion Sensor Default Settings

Option	Dimmed State	High Level (when triggered)	Photocell Operation	Dwell Time	Ramp-up Time	Ramp-down Time
PIR or PIRH	3V (37%) Output	10V (100%) Output	Enabled @ 5FC	5 min	3 sec	5 min
*PIR1FC3V or PIRH1FC3V	3V (37%) Output	10V (100%) Output	Enabled @ 1FC	5 min	3 sec	5 min

\*for use when motion sensor is used as dusk to dawn control.

### Electrical Load

	Performance Package	LED Count	Drive Current	Wattage	Current (A)					
					120	208	240	277	347	480
Forward Optics (Non-Rotated)	P1	30	530	54	0.45	0.26	0.23	0.19	0.10	0.12
	P2	30	700	70	0.59	0.34	0.30	0.25	0.20	0.16
	P3	30	1050	102	0.86	0.50	0.44	0.38	0.30	0.22
	P4	30	1250	125	1.06	0.60	0.52	0.46	0.37	0.27
	P5	30	1400	138	1.16	0.67	0.58	0.51	0.40	0.29
	P6	40	1250	163	1.36	0.78	0.68	0.59	0.47	0.34
	P7	40	1400	183	1.53	0.88	0.76	0.66	0.53	0.38
	P8	60	1050	207	1.74	0.98	0.87	0.76	0.64	0.49
	P9	60	1250	241	2.01	1.16	1.01	0.89	0.70	0.51
Rotated Optics (Requires L90 or R90)	P10	60	530	106	0.90	0.52	0.47	0.43	0.33	0.27
	P11	60	700	137	1.15	0.67	0.60	0.53	0.42	0.32
	P12	60	1050	207	1.74	0.99	0.87	0.76	0.60	0.46
	P13	60	1250	231	1.93	1.12	0.97	0.86	0.67	0.49

#### Controls Options

Nomenclature	Description	Functionality	Primary control device	Notes
FA0	Field adjustable output device installed inside the luminaire; wired to the driver dimming leads.	Allows the luminaire to be manually dimmed, effectively trimming the light output.	FA0 device	Cannot be used with other controls options that need the 0-10V leads
DS	Drivers wired independently for 50/50 luminaire operation	The luminaire is wired to two separate circuits, allowing for 50/50 operation.	Independently wired drivers	Requires two separately switched circuits. Consider nLight AIR as a more cost effective alternative.
PERS or PER7	Twist-lock photocell receptacle	Compatible with standard twist-lock photocells for dusk to dawn operation, or advanced control nodes that provide 0-10V dimming signals.	Twist-lock photocells such as DLL Elite or advanced control nodes such as ROAM.	Pins 4 & 5 to dimming leads on driver, Pins 6 & 7 are capped inside luminaire
PIR or PIRH	Motion sensors with integral photocell. PIR for 8-15' mounting; PIRH for 15-30' mounting	Luminaires dim when no occupancy is detected.	Acuity Controls SBOR	Also available with PIRH1FC3V when the sensor photocell is used for dusk-to-dawn operation.
NLTAIR2 PIRHN	nLight AIR enabled luminaire for motion sensing, photocell and wireless communication.	Motion and ambient light sensing with group response. Scheduled dimming with motion sensor over-ride when wirelessly connected to the nLight Eclipse.	nLight Air rSDGR	nLight AIR sensors can be programmed and commissioned from the ground using the CIAIRity Pro app.

# Performance Data

## Lumen Output

Lumen values are from photometric tests performed in accordance with IESNA LM-79-08. Data is considered to be representative of the configurations shown, within the tolerances allowed by Lighting Facts Contact factory for performance data on any configurations not shown here.

Forward Optics																							
LED Count	Drive Current	Power Package	System Watts	Dist. Type	30K (3000 K, 70 CRI)					40K (4000 K, 70 CRI)					50K (5000 K, 70 CRI)								
					Lumens	B	U	G	LPW	Lumens	B	U	G	LPW	Lumens	B	U	G	LPW				
30	530	P1	54W	T1S	6,457	2	0	2	120	6,956	2	0	2	129	7,044	2	0	2	130				
				T2S	6,450	2	0	2	119	6,949	2	0	2	129	7,037	2	0	2	130				
				T2M	6,483	1	0	1	120	6,984	2	0	2	129	7,073	2	0	2	131				
				T3S	6,279	2	0	2	116	6,764	2	0	2	125	6,850	2	0	2	127				
				T3M	6,468	1	0	2	120	6,967	1	0	2	129	7,056	1	0	2	131				
				T4M	6,327	1	0	2	117	6,816	1	0	2	126	6,902	1	0	2	128				
				TFTM	6,464	1	0	2	120	6,963	1	0	2	129	7,051	1	0	2	131				
				TSVS	6,722	2	0	0	124	7,242	3	0	0	134	7,334	3	0	0	136				
				T5S	6,728	2	0	1	125	7,248	2	0	1	134	7,340	2	0	1	136				
				T5M	6,711	3	0	1	124	7,229	3	0	1	134	7,321	3	0	2	136				
				TSW	6,667	3	0	2	123	7,182	3	0	2	133	7,273	3	0	2	135				
				BLC	5,299	1	0	1	98	5,709	1	0	2	106	5,781	1	0	2	107				
				LCCO	3,943	1	0	2	73	4,248	1	0	2	79	4,302	1	0	2	80				
				RCCO	3,943	1	0	2	73	4,248	1	0	2	79	4,302	1	0	2	80				
				30	700	P2	70W	T1S	8,249	2	0	2	118	8,886	2	0	2	127	8,999	2	0	2	129
								T2S	8,240	2	0	2	118	8,877	2	0	2	127	8,989	2	0	2	128
T2M	8,283	2	0					2	118	8,923	2	0	2	127	9,036	2	0	2	129				
T3S	8,021	2	0					2	115	8,641	2	0	2	123	8,751	2	0	2	125				
T3M	8,263	2	0					2	118	8,901	2	0	2	127	9,014	2	0	2	129				
T4M	8,083	2	0					2	115	8,708	2	0	2	124	8,818	2	0	2	126				
TFTM	8,257	2	0					2	118	8,896	2	0	2	127	9,008	2	0	2	129				
TSVS	8,588	3	0					0	123	9,252	3	0	0	132	9,369	3	0	0	134				
T5S	8,595	3	0					1	123	9,259	3	0	1	132	9,376	3	0	1	134				
T5M	8,573	3	0					2	122	9,236	3	0	2	132	9,353	3	0	2	134				
TSW	8,517	3	0					2	122	9,175	4	0	2	131	9,291	4	0	2	133				
BLC	6,770	1	0					2	97	7,293	1	0	2	104	7,386	1	0	2	106				
LCCO	5,038	1	0					2	72	5,427	1	0	2	78	5,496	1	0	2	79				
RCCO	5,038	1	0					2	72	5,427	1	0	2	78	5,496	1	0	2	79				
30	1050	P3	102W					T1S	11,661	2	0	2	114	12,562	3	0	3	123	12,721	3	0	3	125
								T2S	11,648	2	0	2	114	12,548	3	0	3	123	12,707	3	0	3	125
				T2M	11,708	2	0	2	115	12,613	2	0	2	124	12,773	2	0	2	125				
				T3S	11,339	2	0	2	111	12,215	3	0	3	120	12,370	3	0	3	121				
				T3M	11,680	2	0	2	115	12,582	2	0	2	123	12,742	2	0	2	125				
				T4M	11,426	2	0	3	112	12,309	2	0	3	121	12,465	2	0	3	122				
				TFTM	11,673	2	0	2	114	12,575	2	0	3	123	12,734	2	0	3	125				
				TSVS	12,140	3	0	1	119	13,078	3	0	1	128	13,244	3	0	1	130				
				T5S	12,150	3	0	1	119	13,089	3	0	1	128	13,254	3	0	1	130				
				T5M	12,119	4	0	2	119	13,056	4	0	2	128	13,221	4	0	2	130				
				TSW	12,040	4	0	3	118	12,970	4	0	3	127	13,134	4	0	3	129				
				BLC	9,570	1	0	2	94	10,310	1	0	2	101	10,440	1	0	2	102				
				LCCO	7,121	1	0	3	70	7,671	1	0	3	75	7,768	1	0	3	76				
				RCCO	7,121	1	0	3	70	7,671	1	0	3	75	7,768	1	0	3	76				
				30	1250	P4	125W	T1S	13,435	3	0	3	107	14,473	3	0	3	116	14,657	3	0	3	117
								T2S	13,421	3	0	3	107	14,458	3	0	3	116	14,641	3	0	3	117
T2M	13,490	2	0					2	108	14,532	3	0	3	116	14,716	3	0	3	118				
T3S	13,064	3	0					3	105	14,074	3	0	3	113	14,252	3	0	3	114				
T3M	13,457	2	0					2	108	14,497	2	0	2	116	14,681	2	0	2	117				
T4M	13,165	2	0					3	105	14,182	2	0	3	113	14,362	2	0	3	115				
TFTM	13,449	2	0					3	108	14,488	2	0	3	116	14,672	2	0	3	117				
TSVS	13,987	4	0					1	112	15,068	4	0	1	121	15,259	4	0	1	122				
T5S	13,999	3	0					1	112	15,080	3	0	1	121	15,271	3	0	1	122				
T5M	13,963	4	0					2	112	15,042	4	0	2	120	15,233	4	0	2	122				
TSW	13,872	4	0					3	111	14,944	4	0	3	120	15,133	4	0	3	121				
BLC	11,027	1	0					2	88	11,879	1	0	2	95	12,029	1	0	2	96				
LCCO	8,205	1	0					3	66	8,839	1	0	3	71	8,951	1	0	3	72				
RCCO	8,205	1	0					3	66	8,839	1	0	3	71	8,951	1	0	3	72				
30	1400	P5	138W					T1S	14,679	3	0	3	106	15,814	3	0	3	115	16,014	3	0	3	116
								T2S	14,664	3	0	3	106	15,797	3	0	3	114	15,997	3	0	3	116
				T2M	14,739	3	0	3	107	15,878	3	0	3	115	16,079	3	0	3	117				
				T3S	14,274	3	0	3	103	15,377	3	0	3	111	15,572	3	0	3	113				
				T3M	14,704	2	0	3	107	15,840	3	0	3	115	16,040	3	0	3	116				
				T4M	14,384	2	0	3	104	15,496	3	0	3	112	15,692	3	0	3	114				
				TFTM	14,695	2	0	3	106	15,830	3	0	3	115	16,030	3	0	3	116				
				TSVS	15,283	4	0	1	111	16,464	4	0	1	119	16,672	4	0	1	121				
				T5S	15,295	3	0	1	111	16,477	4	0	1	119	16,686	4	0	1	121				
				T5M	15,257	4	0	2	111	16,435	4	0	2	119	16,644	4	0	2	121				
				TSW	15,157	4	0	3	110	16,328	4	0	3	118	16,534	4	0	3	120				
				BLC	12,048	1	0	2	87	12,979	1	0	2	94	13,143	1	0	2	95				
				LCCO	8,965	1	0	3	65	9,657	1	0	3	70	9,780	1	0	3	71				
				RCCO	8,965	1	0	3	65	9,657	1	0	3	70	9,780	1	0	3	71				



# Performance Data

## Lumen Output

Lumen values are from photometric tests performed in accordance with IESNA LM-79-08. Data is considered to be representative of the configurations shown, within the tolerances allowed by Lighting Facts. Contact factory for performance data on any configurations not shown here.

Forward Optics																			
LED Count	Drive Current	Power Package	System Watts	Dist. Type	30K (3000 K, 70 CRI)					40K (4000 K, 70 CRI)					50K (5000 K, 70 CRI)				
					Lumens	B	U	G	LPW	Lumens	B	U	G	LPW	Lumens	B	U	G	LPW
40	1250	P6	163W	T1S	17,654	3	0	3	108	19,018	3	0	3	117	19,259	3	0	3	118
				T2S	17,635	3	0	3	108	18,998	3	0	3	117	19,238	3	0	3	118
				T2M	17,726	3	0	3	109	19,096	3	0	3	117	19,337	3	0	3	119
				T3S	17,167	3	0	3	105	18,493	3	0	3	113	18,727	3	0	3	115
				T3M	17,683	3	0	3	108	19,049	3	0	3	117	19,290	3	0	3	118
				T4M	17,299	3	0	3	106	18,635	3	0	4	114	18,871	3	0	4	116
				TFTM	17,672	3	0	3	108	19,038	3	0	4	117	19,279	3	0	4	118
				TSVS	18,379	4	0	1	113	19,800	4	0	1	121	20,050	4	0	1	123
				T5S	18,394	4	0	2	113	19,816	4	0	2	122	20,066	4	0	2	123
				T5M	18,348	4	0	2	113	19,766	4	0	2	121	20,016	4	0	2	123
				TSW	18,228	5	0	3	112	19,636	5	0	3	120	19,885	5	0	3	122
				BLC	14,489	2	0	2	89	15,609	2	0	3	96	15,806	2	0	3	97
				LCCO	10,781	1	0	3	66	11,614	1	0	3	71	11,761	2	0	3	72
				RCCO	10,781	1	0	3	66	11,614	1	0	3	71	11,761	2	0	3	72
40	1400	P7	183W	T1S	19,227	3	0	3	105	20,712	3	0	3	113	20,975	3	0	3	115
				T2S	19,206	3	0	3	105	20,690	3	0	3	113	20,952	3	0	3	114
				T2M	19,305	3	0	3	105	20,797	3	0	3	114	21,060	3	0	3	115
				T3S	18,696	3	0	3	102	20,141	3	0	3	110	20,396	3	0	4	111
				T3M	19,258	3	0	3	105	20,746	3	0	3	113	21,009	3	0	3	115
				T4M	18,840	3	0	4	103	20,296	3	0	4	111	20,553	3	0	4	112
				TFTM	19,246	3	0	4	105	20,734	3	0	4	113	20,996	3	0	4	115
				TSVS	20,017	4	0	1	109	21,564	4	0	1	118	21,837	4	0	1	119
				T5S	20,033	4	0	2	109	21,581	4	0	2	118	21,854	4	0	2	119
				T5M	19,983	4	0	2	109	21,527	5	0	3	118	21,799	5	0	3	119
				TSW	19,852	5	0	3	108	21,386	5	0	3	117	21,656	5	0	3	118
				BLC	15,780	2	0	3	86	16,999	2	0	3	93	17,214	2	0	3	94
				LCCO	11,742	2	0	3	64	12,649	2	0	3	69	12,809	2	0	3	70
				RCCO	11,742	2	0	3	64	12,649	2	0	3	69	12,809	2	0	3	70
60	1050	P8	207W	T1S	22,490	3	0	3	109	24,228	3	0	3	117	24,535	3	0	3	119
				T2S	22,466	3	0	4	109	24,202	3	0	4	117	24,509	3	0	4	118
				T2M	22,582	3	0	3	109	24,327	3	0	3	118	24,635	3	0	3	119
				T3S	21,870	3	0	4	106	23,560	3	0	4	114	23,858	3	0	4	115
				T3M	22,527	3	0	4	109	24,268	3	0	4	117	24,575	3	0	4	119
				T4M	22,038	3	0	4	106	23,741	3	0	4	115	24,041	3	0	4	116
				TFTM	22,513	3	0	4	109	24,253	3	0	4	117	24,560	3	0	4	119
				TSVS	23,415	5	0	1	113	25,224	5	0	1	122	25,543	5	0	1	123
				T5S	23,434	4	0	2	113	25,244	4	0	2	122	25,564	4	0	2	123
				T5M	23,374	5	0	3	113	25,181	5	0	3	122	25,499	5	0	3	123
				TSW	23,221	5	0	4	112	25,016	5	0	4	121	25,332	5	0	4	122
				BLC	18,458	2	0	3	89	19,885	2	0	3	96	20,136	2	0	3	97
				LCCO	13,735	2	0	3	66	14,796	2	0	4	71	14,983	2	0	4	72
				RCCO	13,735	2	0	3	66	14,796	2	0	4	71	14,983	2	0	4	72
60	1250	P9	241W	T1S	25,575	3	0	3	106	27,551	3	0	3	114	27,900	3	0	3	116
				T2S	25,548	3	0	4	106	27,522	3	0	4	114	27,871	3	0	4	116
				T2M	25,680	3	0	3	107	27,664	3	0	3	115	28,014	3	0	3	116
				T3S	24,870	3	0	4	103	26,791	3	0	4	111	27,130	3	0	4	113
				T3M	25,617	3	0	4	106	27,597	3	0	4	115	27,946	3	0	4	116
				T4M	25,061	3	0	4	104	26,997	3	0	4	112	27,339	3	0	4	113
				TFTM	25,602	3	0	4	106	27,580	3	0	4	114	27,929	3	0	4	116
				TSVS	26,626	5	0	1	110	28,684	5	0	1	119	29,047	5	0	1	121
				T5S	26,648	4	0	2	111	28,707	5	0	2	119	29,070	5	0	2	121
				T5M	26,581	5	0	3	110	28,635	5	0	3	119	28,997	5	0	3	120
				TSW	26,406	5	0	4	110	28,447	5	0	4	118	28,807	5	0	4	120
				BLC	20,990	2	0	3	87	22,612	2	0	3	94	22,898	2	0	3	95
				LCCO	15,619	2	0	4	65	16,825	2	0	4	70	17,038	2	0	4	71
				RCCO	15,619	2	0	4	65	16,825	2	0	4	70	17,038	2	0	4	71

# Performance Data

## Lumen Output

Lumen values are from photometric tests performed in accordance with IESNA LM-79-08. Data is considered to be representative of the configurations shown, within the tolerances allowed by Lighting Facts. Contact factory for performance data on any configurations not shown here.

Rotated Optics																			
LED Count	Drive Current	Power Package	System Watts	Dist. Type	30K (3000 K, 70 CRI)					40K (4000 K, 70 CRI)					50K (5000 K, 70 CRI)				
					Lumens	B	U	G	LPW	Lumens	B	U	G	LPW	Lumens	B	U	G	LPW
60	530	P10	106W	T1S	13,042	3	0	3	123	14,050	3	0	3	133	14,228	3	0	3	134
				T2S	12,967	4	0	4	122	13,969	4	0	4	132	14,146	4	0	4	133
				T2M	13,201	3	0	3	125	14,221	3	0	3	134	14,401	3	0	3	136
				T3S	12,766	4	0	4	120	13,752	4	0	4	130	13,926	4	0	4	131
				T3M	13,193	4	0	4	124	14,213	4	0	4	134	14,393	4	0	4	136
				T4M	12,944	4	0	4	122	13,945	4	0	4	132	14,121	4	0	4	133
				TFTM	13,279	4	0	4	125	14,305	4	0	4	135	14,486	4	0	4	137
				TSVS	13,372	3	0	1	126	14,405	4	0	1	136	14,588	4	0	1	138
				T5S	13,260	3	0	1	125	14,284	3	0	1	135	14,465	3	0	1	136
				T5M	13,256	4	0	2	125	14,281	4	0	2	135	14,462	4	0	2	136
				TSW	13,137	4	0	3	124	14,153	4	0	3	134	14,332	4	0	3	135
				BLC	10,906	3	0	3	103	11,749	3	0	3	111	11,898	3	0	3	112
				LCCO	7,789	1	0	3	73	8,391	1	0	3	79	8,497	1	0	3	80
				RCCO	7,779	4	0	4	73	8,380	4	0	4	79	8,486	4	0	4	80
60	700	P11	137W	T1S	16,556	3	0	3	121	17,835	3	0	3	130	18,061	4	0	4	132
				T2S	16,461	4	0	4	120	17,733	4	0	4	129	17,957	4	0	4	131
				T2M	16,758	4	0	4	122	18,053	4	0	4	132	18,281	4	0	4	133
				T3S	16,205	4	0	4	118	17,457	4	0	4	127	17,678	4	0	4	129
				T3M	16,748	4	0	4	122	18,042	4	0	4	132	18,271	4	0	4	133
				T4M	16,432	4	0	4	120	17,702	4	0	4	129	17,926	4	0	4	131
				TFTM	16,857	4	0	4	123	18,159	4	0	4	133	18,389	4	0	4	134
				TSVS	16,975	4	0	1	124	18,287	4	0	1	133	18,518	4	0	1	135
				T5S	16,832	4	0	1	123	18,133	4	0	2	132	18,362	4	0	2	134
				T5M	16,828	4	0	2	123	18,128	4	0	2	132	18,358	4	0	2	134
				TSW	16,677	4	0	3	122	17,966	5	0	3	131	18,193	5	0	3	133
				BLC	13,845	3	0	3	101	14,915	3	0	3	109	15,103	3	0	3	110
				LCCO	9,888	1	0	3	72	10,652	2	0	3	78	10,787	2	0	3	79
				RCCO	9,875	4	0	4	72	10,638	4	0	4	78	10,773	4	0	4	79
60	1050	P12	207W	T1S	22,996	4	0	4	111	24,773	4	0	4	120	25,087	4	0	4	121
				T2S	22,864	4	0	4	110	24,631	5	0	5	119	24,943	5	0	5	120
				T2M	23,277	4	0	4	112	25,075	4	0	4	121	25,393	4	0	4	123
				T3S	22,509	4	0	4	109	24,248	5	0	5	117	24,555	5	0	5	119
				T3M	23,263	4	0	4	112	25,061	4	0	4	121	25,378	4	0	4	123
				T4M	22,824	5	0	5	110	24,588	5	0	5	119	24,899	5	0	5	120
				TFTM	23,414	5	0	5	113	25,223	5	0	5	122	25,543	5	0	5	123
				TSVS	23,579	5	0	1	114	25,401	5	0	1	123	25,722	5	0	1	124
				T5S	23,380	4	0	2	113	25,187	4	0	2	122	25,506	4	0	2	123
				T5M	23,374	5	0	3	113	25,181	5	0	3	122	25,499	5	0	3	123
				TSW	23,165	5	0	4	112	24,955	5	0	4	121	25,271	5	0	4	122
				BLC	19,231	4	0	4	93	20,717	4	0	4	100	20,979	4	0	4	101
				LCCO	13,734	2	0	3	66	14,796	2	0	4	71	14,983	2	0	4	72
				RCCO	13,716	4	0	4	66	14,776	4	0	4	71	14,963	4	0	4	72
60	1250	P13	231W	T1S	25,400	4	0	4	110	27,363	4	0	4	118	27,709	4	0	4	120
				T2S	25,254	5	0	5	109	27,205	5	0	5	118	27,550	5	0	5	119
				T2M	25,710	4	0	4	111	27,696	4	0	4	120	28,047	4	0	4	121
				T3S	24,862	5	0	5	108	26,783	5	0	5	116	27,122	5	0	5	117
				T3M	25,695	5	0	5	111	27,680	5	0	5	120	28,031	5	0	5	121
				T4M	25,210	5	0	5	109	27,158	5	0	5	118	27,502	5	0	5	119
				TFTM	25,861	5	0	5	112	27,860	5	0	5	121	28,212	5	0	5	122
				TSVS	26,043	5	0	1	113	28,056	5	0	1	121	28,411	5	0	1	123
				T5S	25,824	4	0	2	112	27,819	5	0	2	120	28,172	5	0	2	122
				T5M	25,818	5	0	3	112	27,813	5	0	3	120	28,165	5	0	3	122
				TSW	25,586	5	0	4	111	27,563	5	0	4	119	27,912	5	0	4	121
				BLC	21,241	4	0	4	92	22,882	4	0	4	99	23,172	4	0	4	100
				LCCO	15,170	2	0	4	66	16,342	2	0	4	71	16,549	2	0	4	72
				RCCO	15,150	5	0	5	66	16,321	5	0	5	71	16,527	5	0	5	72

## A+ Capable Luminaire

This item is an A+ capable luminaire, which has been designed and tested to provide consistent color appearance and system-level interoperability.

- All configurations of this luminaire meet the Acuity Brands' specification for chromatic consistency
- This luminaire is A+ Certified when ordered with DTL® controls marked by a shaded background. DTL DLL equipped luminaires meet the A+ specification for luminaire to photocontrol interoperability<sup>1</sup>
- This luminaire is part of an A+ Certified solution for ROAM® or XPoint™ Wireless control networks, providing out-of-the-box control compatibility with simple commissioning, when ordered with drivers and control options marked by a shaded background<sup>1</sup>

To learn more about A+, visit [www.acuitybrands.com/aplus](http://www.acuitybrands.com/aplus).

1. See ordering tree for details.
2. A+ Certified Solutions for ROAM require the order of one ROAM node per luminaire. Sold Separately: [Link to Roam](#); [Link to DTL DLL](#)

## FEATURES & SPECIFICATIONS

### INTENDED USE

The sleek design of the D-Series Size 1 reflects the embedded high performance LED technology. It is ideal for many commercial and municipal applications, such as parking lots, plazas, campuses, and streetscapes.

### CONSTRUCTION

Single-piece die-cast aluminum housing has integral heat sink fins to optimize thermal management through conductive and convective cooling. Modular design allows for ease of maintenance and future light engine upgrades. The LED drivers are mounted in direct contact with the casting to promote low operating temperature and long life. Housing is completely sealed against moisture and environmental contaminants (IP65). Low EPA (1.01 ft<sup>2</sup>) for optimized pole wind loading.

### FINISH

Exterior parts are protected by a zinc-infused Super Durable TGIC thermoset powder coat finish that provides superior resistance to corrosion and weathering. A tightly controlled multi-stage process ensures a minimum 3 mils thickness for a finish that can withstand extreme climate changes without cracking or peeling. Available in both textured and non-textured finishes.

### OPTICS

Precision-molded proprietary acrylic lenses are engineered for superior area lighting distribution, uniformity, and pole spacing. Light engines are available in standard 3000 K, 4000 K and 5000 K (70 CRI) configurations. The D-Series Size 1 has zero uplight and qualifies as a Nighttime Friendly™ product, meaning it is consistent with the LEED® and Green Globes™ criteria for eliminating wasteful uplight.

### ELECTRICAL

Light engine configurations consist of high-efficacy LEDs mounted to metal-core circuit boards to maximize heat dissipation and promote long life (up to L85/100,000 hours at 25°C). Class 1 electronic drivers are designed to have a power factor >90%, THD <20%, and an expected life of 100,000 hours with <1% failure rate. Easily serviceable 10kV surge protection device meets a minimum Category C Low operation (per ANSI/IEEE C62.41.2).

### STANDARD CONTROLS

The DSX1 LED area luminaire has a number of control options. Dusk to dawn controls can be utilized via optional NEMA twist-lock photocell receptacles. Integrated motion sensors with on-board photocells feature field-adjustable programming and are suitable for mounting heights up to 30 feet.

### nLIGHT AIR CONTROLS

The DSX1 LED area luminaire is also available with nLight® AIR for the ultimate in wireless control. This powerful controls platform provides out-of-the-box basic motion sensing and photocontrol functionality and is suitable for mounting heights up to 40 feet. Once commissioned using a smartphone and the easy-to-use CLAIRITY app, nLight AIR equipped luminaires can be grouped, resulting in motion sensor and photocell group response without the need for additional equipment. Scheduled dimming with motion sensor over-ride can be achieved when used with the nLight Eclipse. Additional information about nLight Air can be found here.

### INSTALLATION

Included mounting block and integral arm facilitate quick and easy installation. Stainless steel bolts fasten the mounting block securely to poles and walls, enabling the D-Series Size 1 to withstand up to a 3.0 G vibration load rating per ANSI C136.31. The D-Series Size 1 utilizes the AERIS™ series pole drilling pattern (template #8). NEMA photocontrol receptacle are also available.

### LISTINGS

UL Listed for wet locations. Light engines are IP66 rated; luminaire is IP65 rated. Rated for -40°C minimum ambient. U.S. Patent No. D672,492 S. International patent pending.

DesignLights Consortium® (DLC) Premium qualified product and DLC qualified product.

Not all versions of this product may be DLC Premium qualified or DLC qualified. Please check the DLC Qualified Products List at [www.designlights.org/QPL](http://www.designlights.org/QPL) to confirm which versions are qualified.

International Dark-Sky Association (IDA) Fixture Seal of Approval (FSA) is available for all products on this page utilizing 3000K color temperature only.

### WARRANTY

5-year limited warranty. Complete warranty terms located at: [www.acuitybrands.com/CustomResources/Terms\\_and\\_conditions.aspx](http://www.acuitybrands.com/CustomResources/Terms_and_conditions.aspx)

**Note:** Actual performance may differ as a result of end-user environment and application.

All values are design or typical values, measured under laboratory conditions at 25 °C.

Specifications subject to change without notice.





# D-Series Size 1 LED Area Luminaire

d#series



Catalog Number
Notes
Type

Hit the Tab key or mouse over the page to see all interactive elements.

## Specifications

<b>EPA:</b>	1.01 ft <sup>2</sup> (0.09 m <sup>2</sup> )
<b>Length:</b>	33" (83.8 cm)
<b>Width:</b>	13" (33.0 cm)
<b>Height H1:</b>	7-1/2" (19.0 cm)
<b>Height H2:</b>	3-1/2"
<b>Weight (max):</b>	27 lbs (12.2 kg)

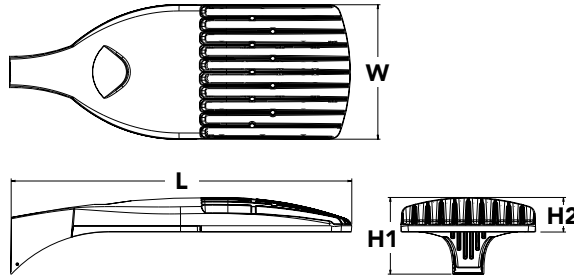

## Introduction

The modern styling of the D-Series is striking yet unobtrusive - making a bold, progressive statement even as it blends seamlessly with its environment. The D-Series distills the benefits of the latest in LED technology into a high performance, high efficacy, long-life luminaire.

The outstanding photometric performance results in sites with excellent uniformity, greater pole spacing and lower power density. It is ideal for replacing up to 750W metal halide in pedestrian and area lighting applications with typical energy savings of 65% and expected service life of over 100,000 hours.

A+ Capable options indicated by this color background.

## Ordering Information

**EXAMPLE:** DSX1 LED P7 40K T3M MVOLT SPA NLTAIR2 PIRHN DDBXD

DSX1 LED							
Series	LEDs	Color temperature		Distribution		Voltage	Mounting
<b>DSX1 LED</b>	<b>Forward optics</b> P1 <b>P4</b> P7 P2 P5 P8 P3 P6 P9 <b>Rotated optics</b> P10 <sup>1</sup> P12 <sup>1</sup> P11 <sup>1</sup> P13 <sup>1</sup>	30K 40K <b>50K</b>	3000 K 4000 K <b>5000 K</b>	T1S Type I short T2S Type II short T2M Type II medium T3S Type III short T3M Type III medium T4M Type IV medium <b>TFTM</b> Forward throw medium	T5VS Type V very short T5S Type V short T5M Type V medium T5W Type V wide BLC Backlight control <sup>2</sup> LCCO Left corner cutoff <sup>2</sup> RCCO Right corner cutoff <sup>2</sup>	<b>MVOLT<sup>3</sup></b> 120 <sup>4</sup> 208 <sup>4</sup> 240 <sup>4</sup> 277 <sup>4</sup> 347 <sup>4,5</sup> 480 <sup>4,5</sup>	<b>Shipped included</b> <b>SPA</b> <b>Square pole mounting</b> RPA Round pole mounting WBA Wall bracket SPUMBA Square pole universal mounting adaptor <sup>6</sup> RPUMBA Round pole universal mounting adaptor <sup>6</sup> <b>Shipped separately</b> KMA8 DDBXD U Mast arm mounting bracket adaptor (specify finish) <sup>7</sup>

Control options	Other options	Finish (required)
<b>Shipped installed</b> NLTAIR2 nLight AIR generation 2 enabled <sup>8</sup> PIRHN Network, high/low motion/ambient sensor <sup>9</sup> PER NEMA twist-lock receptacle only (controls ordered separate) <sup>10</sup> PER5 Five-pin receptacle only (controls ordered separate) <sup>10,11</sup> PER7 Seven-pin receptacle only (controls ordered separate) <sup>10,11</sup> DMG 0-10v dimming wires pulled outside fixture (for use with an external control, ordered separately) <sup>12</sup> DS Dual switching <sup>12,13,14</sup>	<b>Shipped installed</b> <b>HS</b> <b>House-side shield<sup>17</sup></b> SF Single fuse (120, 277, 347V) <sup>4</sup> DF Double fuse (208, 240, 480V) <sup>4</sup> L90 Left rotated optics <sup>1</sup> R90 Right rotated optics <sup>1</sup> <b>Shipped separately</b> BS Bird spikes <sup>18</sup> EGS External glare shield <sup>18</sup>	DDBXD Dark bronze DBLXD Black DNAXD Natural aluminum DWHXD White DDBTXD Textured dark bronze DDBLXDXD Textured black DNATXDXD Textured natural aluminum DWHGXDXD Textured white
PIR High/low, motion/ambient sensor, 8-15' mounting height, ambient sensor enabled at 5fc <sup>15,16</sup> PIRH High/low, motion/ambient sensor, 15-30' mounting height, ambient sensor enabled at 5fc <sup>15,16</sup> PIR1FC3V High/low, motion/ambient sensor, 8-15' mounting height, ambient sensor enabled at 1fc <sup>15,16</sup> PIRH1FC3V Bi-level, motion/ambient sensor, 15-30' mounting height, ambient sensor enabled at 1fc <sup>15,16</sup> FAO Field adjustable output <sup>14</sup>		





## Ordering Information

### Accessories

Ordered and shipped separately.

DLL127F 1.5 JU	Photocell - SSL twist-lock (120-277V) <sup>19</sup>
DLL347F 1.5 CUL JU	Photocell - SSL twist-lock (347V) <sup>19</sup>
DLL480F 1.5 CUL JU	Photocell - SSL twist-lock (480V) <sup>19</sup>
DSHORT SBK U	Shorting cap <sup>19</sup>
DSX1HS 30C U	House-side shield for P1, P2, P3, P4 and P5 <sup>17</sup>
DSX1HS 40C U	House-side shield for P6 and P7 <sup>17</sup>
DSX1HS 60C U	House-side shield for P8, P9, P10, P11 and P12 <sup>17</sup>
PUMBA DDBXD U*	Square and round pole universal mounting bracket (specify finish) <sup>20</sup>
KMA8 DDBXD U	Mast arm mounting bracket adaptor (specify finish) <sup>6</sup>

For more control options, visit [DTL](#) and [ROAM](#) online.

### NOTES

- P10, P11, P12 or P13 and rotated optics (L90, R90) only available together.
- Not available with HS.
- MVOLT driver operates on any line voltage from 120-277V (50/60 Hz).
- Single fuse (SF) requires 120V, 277V or 347V. Double fuse (DF) requires 208V, 240V or 480V.
- Not available in P1 or P10.
- Universal mounting brackets intended for retrofit on existing, pre-drilled poles only. 1.5 G vibration load rating per ANCI C136.31.
- Must order fixture with SPA option. Must be ordered as a separate accessory; see Accessories information. For use with 2-3/8" mast arm (not included).
- Must be ordered with PIRHN. Sensor cover available only in dark bronze, black, white and natural aluminum colors.
- Must be ordered with NLTAIR2. For more information on Light Air 2 visit [this link](#).
- Photocell ordered and shipped as a separate line item from Acuity Brands Controls. See accessories. Not available with DS option. Shorting cap included.
- If ROAM® node required, it must be ordered and shipped as a separate line item from Acuity Brands Controls. Node with integral dimming.
- Provides 50/50 fixture operation via (2) independent drivers. Not available with PER, PER5, PER7, PIR or PIRH. Not available P1, P2, P3, P4 or P5.
- Requires (2) separately switched circuits with isolated neutral. See Outdoor Control Technical Guide for details.
- Reference Motion Sensor table on page 4.
- Reference controls options table on page 4 to see functionality.
- Not available with other dimming controls options
- Not available with BLC, LCCO and RCCO distribution. Also available as a separate accessory; see Accessories information.
- Must be ordered with fixture for factory pre-drilling.
- Requires luminaire to be specified with PER, PER5 or PER7 option. See PER Table on page 3.
- For retrofit use only.

## Options

### EGS - External Glare Shield

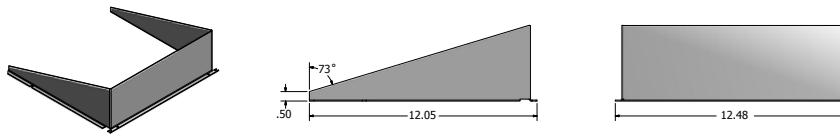

## Drilling

### HANDHOLE ORIENTATION

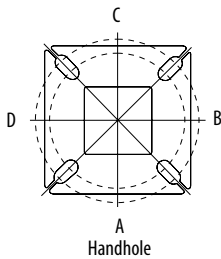

### Tenon Mounting Slipfitter\*\*

Tenon O.D.	Mounting	Single Unit	2 @ 180	2 @ 90	3 @ 120	3 @ 90	4 @ 90
2-3/8"	SPA/RPA	AS3-5 190	AS3-5 280	AS3-5 290	AS3-5 320	AS3-5 390	AS3-5 490
	SPUMBA	AS3-5 190	AS3-5 280	AS4-5 290	AS3-5 320	AS4-5 390	AS4-5 490
	RUPUMBA	AS3-5 190	AS3-5 280		AS3-5 320		
2-7/8"	SPA/RPA	AST25-190	AST25-280	AST25-290	AST25-320	AST25-390	AST25-490
	SPUMBA	AST25-190	AST25-280		AST25-320		
	RUPUMBA	AST25-190	AST25-280		AST25-320		
4"	SPA/RPA	AST35-190	AST35-280	AST35-290	AST35-320	AST35-390	AST35-490
	SPUMBA	AST35-190	AST35-280	AST35-290	AST35-320	AST35-390	AST35-490
	RUPUMBA	AST35-190	AST35-280		AST35-320		

Template #8

Top of Pole

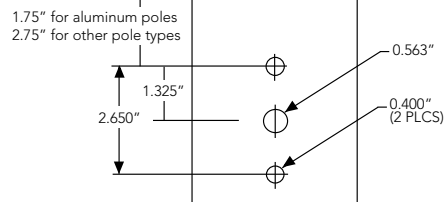

Mounting Option	Drilling Template	Single	2 @ 180	2 @ 90	3 @ 90	3 @ 120	4 @ 90
Head Location		Side B	Side B & D	Side B & C	Side B, C & D	Round Pole Only	Side A, B, C & D
Drill Nomenclature	#8	DM19AS	DM28AS	DM29AS	DM39AS	DM32AS	DM49AS

	Drilling Template	Minimum Acceptable Outside Pole Dimension					
SPA	#8	2-7/8"	2-7/8"	3.5"	3.5"	3"	3.5"
RPA	#8	2-7/8"	2-7/8"	3.5"	3.5"	3"	3.5"
SPUMBA	#5	2-7/8"	3"	4"	4"	3.5"	4"
RPUMBA	#5	2-7/8"	3.5"	5"	5"	3.5"	5"

# Photometric Diagrams

To see complete photometric reports or download .ies files for this product, visit Lithonia Lighting's [D-Series Area Size 1 homepage](#).

Isofootcandle plots for the DSX1 LED 60C 1000 40K. Distances are in units of mounting height (25').

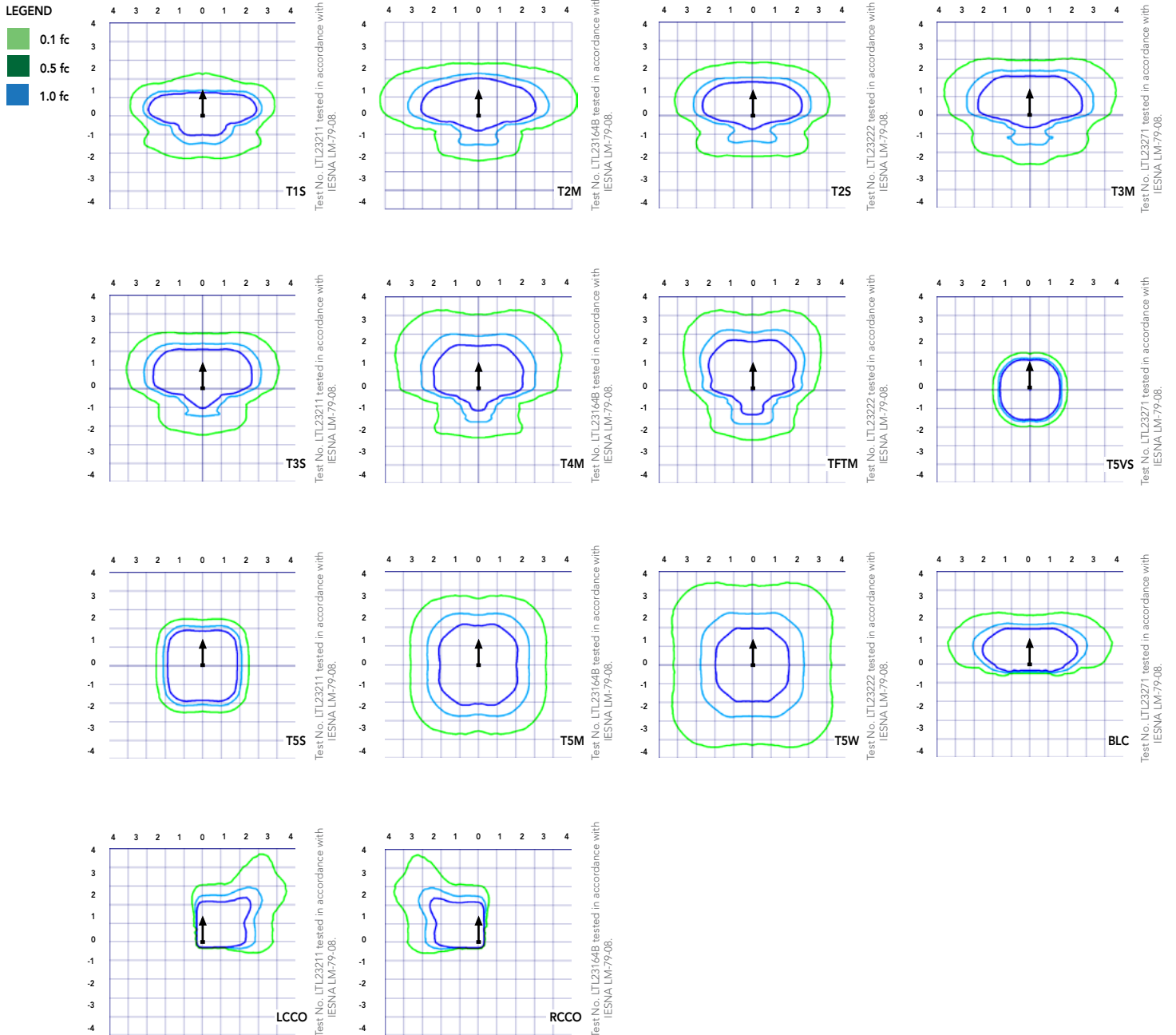

## Performance Data

### Lumen Ambient Temperature (LAT) Multipliers

Use these factors to determine relative lumen output for average ambient temperatures from 0-40°C (32-104°F).

Ambient		Lumen Multiplier
0°C	32°F	1.04
5°C	41°F	1.04
10°C	50°F	1.03
15°C	59°F	1.02
20°C	68°F	1.01
<b>25°C</b>	<b>77°F</b>	<b>1.00</b>
30°C	86°F	0.99
35°C	95°F	0.98
40°C	104°F	0.97

### Projected LED Lumen Maintenance

Data references the extrapolated performance projections for the platforms noted in a **25°C ambient**, based on 10,000 hours of LED testing (tested per IESNA LM-80-08 and projected per IESNA TM-21-11).

To calculate LLF, use the lumen maintenance factor that corresponds to the desired number of operating hours below. For other lumen maintenance values, contact factory.

Operating Hours	Lumen Maintenance Factor
0	1.00
25,000	0.96
50,000	0.92
100,000	0.85

#### Motion Sensor Default Settings

Option	Dimmed State	High Level (when triggered)	Photocell Operation	Dwell Time	Ramp-up Time	Ramp-down Time
PIR or PIRH	3V (37%) Output	10V (100%) Output	Enabled @ 5FC	5 min	3 sec	5 min
*PIR1FC3V or PIRH1FC3V	3V (37%) Output	10V (100%) Output	Enabled @ 1FC	5 min	3 sec	5 min

\*for use when motion sensor is used as dusk to dawn control.

### Electrical Load

	Performance Package	LED Count	Drive Current	Wattage	Current (A)					
					120	208	240	277	347	480
Forward Optics (Non-Rotated)	P1	30	530	54	0.45	0.26	0.23	0.19	0.10	0.12
	P2	30	700	70	0.59	0.34	0.30	0.25	0.20	0.16
	P3	30	1050	102	0.86	0.50	0.44	0.38	0.30	0.22
	P4	30	1250	125	1.06	0.60	0.52	0.46	0.37	0.27
	P5	30	1400	138	1.16	0.67	0.58	0.51	0.40	0.29
	P6	40	1250	163	1.36	0.78	0.68	0.59	0.47	0.34
	P7	40	1400	183	1.53	0.88	0.76	0.66	0.53	0.38
	P8	60	1050	207	1.74	0.98	0.87	0.76	0.64	0.49
	P9	60	1250	241	2.01	1.16	1.01	0.89	0.70	0.51
Rotated Optics (Requires L90 or R90)	P10	60	530	106	0.90	0.52	0.47	0.43	0.33	0.27
	P11	60	700	137	1.15	0.67	0.60	0.53	0.42	0.32
	P12	60	1050	207	1.74	0.99	0.87	0.76	0.60	0.46
	P13	60	1250	231	1.93	1.12	0.97	0.86	0.67	0.49

#### Controls Options

Nomenclature	Description	Functionality	Primary control device	Notes
FA0	Field adjustable output device installed inside the luminaire; wired to the driver dimming leads.	Allows the luminaire to be manually dimmed, effectively trimming the light output.	FA0 device	Cannot be used with other controls options that need the 0-10V leads
DS	Drivers wired independently for 50/50 luminaire operation	The luminaire is wired to two separate circuits, allowing for 50/50 operation.	Independently wired drivers	Requires two separately switched circuits. Consider nLight AIR as a more cost effective alternative.
PERS or PER7	Twist-lock photocell receptacle	Compatible with standard twist-lock photocells for dusk to dawn operation, or advanced control nodes that provide 0-10V dimming signals.	Twist-lock photocells such as DLL Elite or advanced control nodes such as ROAM.	Pins 4 & 5 to dimming leads on driver, Pins 6 & 7 are capped inside luminaire
PIR or PIRH	Motion sensors with integral photocell. PIR for 8-15' mounting; PIRH for 15-30' mounting	Luminaires dim when no occupancy is detected.	Acuity Controls SBOR	Also available with PIRH1FC3V when the sensor photocell is used for dusk-to-dawn operation.
NLTAIR2 PIRHN	nLight AIR enabled luminaire for motion sensing, photocell and wireless communication.	Motion and ambient light sensing with group response. Scheduled dimming with motion sensor over-ride when wirelessly connected to the nLight Eclipse.	nLight Air rSDGR	nLight AIR sensors can be programmed and commissioned from the ground using the CIAIRity Pro app.

# Performance Data

## Lumen Output

Lumen values are from photometric tests performed in accordance with IESNA LM-79-08. Data is considered to be representative of the configurations shown, within the tolerances allowed by Lighting Facts Contact factory for performance data on any configurations not shown here.

Forward Optics																			
LED Count	Drive Current	Power Package	System Watts	Dist. Type	30K (3000 K, 70 CRI)					40K (4000 K, 70 CRI)					50K (5000 K, 70 CRI)				
					Lumens	B	U	G	LPW	Lumens	B	U	G	LPW	Lumens	B	U	G	LPW
30	530	P1	54W	T1S	6,457	2	0	2	120	6,956	2	0	2	129	7,044	2	0	2	130
				T2S	6,450	2	0	2	119	6,949	2	0	2	129	7,037	2	0	2	130
				T2M	6,483	1	0	1	120	6,984	2	0	2	129	7,073	2	0	2	131
				T3S	6,279	2	0	2	116	6,764	2	0	2	125	6,850	2	0	2	127
				T3M	6,468	1	0	2	120	6,967	1	0	2	129	7,056	1	0	2	131
				T4M	6,327	1	0	2	117	6,816	1	0	2	126	6,902	1	0	2	128
				TFTM	6,464	1	0	2	120	6,963	1	0	2	129	7,051	1	0	2	131
				TSVS	6,722	2	0	0	124	7,242	3	0	0	134	7,334	3	0	0	136
				T5S	6,728	2	0	1	125	7,248	2	0	1	134	7,340	2	0	1	136
				T5M	6,711	3	0	1	124	7,229	3	0	1	134	7,321	3	0	2	136
				TSW	6,667	3	0	2	123	7,182	3	0	2	133	7,273	3	0	2	135
				BLC	5,299	1	0	1	98	5,709	1	0	2	106	5,781	1	0	2	107
				LCCO	3,943	1	0	2	73	4,248	1	0	2	79	4,302	1	0	2	80
				RCCO	3,943	1	0	2	73	4,248	1	0	2	79	4,302	1	0	2	80
30	700	P2	70W	T1S	8,249	2	0	2	118	8,886	2	0	2	127	8,999	2	0	2	129
				T2S	8,240	2	0	2	118	8,877	2	0	2	127	8,989	2	0	2	128
				T2M	8,283	2	0	2	118	8,923	2	0	2	127	9,036	2	0	2	129
				T3S	8,021	2	0	2	115	8,641	2	0	2	123	8,751	2	0	2	125
				T3M	8,263	2	0	2	118	8,901	2	0	2	127	9,014	2	0	2	129
				T4M	8,083	2	0	2	115	8,708	2	0	2	124	8,818	2	0	2	126
				TFTM	8,257	2	0	2	118	8,896	2	0	2	127	9,008	2	0	2	129
				TSVS	8,588	3	0	0	123	9,252	3	0	0	132	9,369	3	0	0	134
				T5S	8,595	3	0	1	123	9,259	3	0	1	132	9,376	3	0	1	134
				T5M	8,573	3	0	2	122	9,236	3	0	2	132	9,353	3	0	2	134
				TSW	8,517	3	0	2	122	9,175	4	0	2	131	9,291	4	0	2	133
				BLC	6,770	1	0	2	97	7,293	1	0	2	104	7,386	1	0	2	106
				LCCO	5,038	1	0	2	72	5,427	1	0	2	78	5,496	1	0	2	79
				RCCO	5,038	1	0	2	72	5,427	1	0	2	78	5,496	1	0	2	79
30	1050	P3	102W	T1S	11,661	2	0	2	114	12,562	3	0	3	123	12,721	3	0	3	125
				T2S	11,648	2	0	2	114	12,548	3	0	3	123	12,707	3	0	3	125
				T2M	11,708	2	0	2	115	12,613	2	0	2	124	12,773	2	0	2	125
				T3S	11,339	2	0	2	111	12,215	3	0	3	120	12,370	3	0	3	121
				T3M	11,680	2	0	2	115	12,582	2	0	2	123	12,742	2	0	2	125
				T4M	11,426	2	0	3	112	12,309	2	0	3	121	12,465	2	0	3	122
				TFTM	11,673	2	0	2	114	12,575	2	0	3	123	12,734	2	0	3	125
				TSVS	12,140	3	0	1	119	13,078	3	0	1	128	13,244	3	0	1	130
				T5S	12,150	3	0	1	119	13,089	3	0	1	128	13,254	3	0	1	130
				T5M	12,119	4	0	2	119	13,056	4	0	2	128	13,221	4	0	2	130
				TSW	12,040	4	0	3	118	12,970	4	0	3	127	13,134	4	0	3	129
				BLC	9,570	1	0	2	94	10,310	1	0	2	101	10,440	1	0	2	102
				LCCO	7,121	1	0	3	70	7,671	1	0	3	75	7,768	1	0	3	76
				RCCO	7,121	1	0	3	70	7,671	1	0	3	75	7,768	1	0	3	76
30	1250	P4	125W	T1S	13,435	3	0	3	107	14,473	3	0	3	116	14,657	3	0	3	117
				T2S	13,421	3	0	3	107	14,458	3	0	3	116	14,641	3	0	3	117
				T2M	13,490	2	0	2	108	14,532	3	0	3	116	14,716	3	0	3	118
				T3S	13,064	3	0	3	105	14,074	3	0	3	113	14,252	3	0	3	114
				T3M	13,457	2	0	2	108	14,497	2	0	2	116	14,681	2	0	2	117
				T4M	13,165	2	0	3	105	14,182	2	0	3	113	14,362	2	0	3	115
				TFTM	13,449	2	0	3	108	14,488	2	0	3	116	14,672	2	0	3	117
				TSVS	13,987	4	0	1	112	15,068	4	0	1	121	15,259	4	0	1	122
				T5S	13,999	3	0	1	112	15,080	3	0	1	121	15,271	3	0	1	122
				T5M	13,963	4	0	2	112	15,042	4	0	2	120	15,233	4	0	2	122
				TSW	13,872	4	0	3	111	14,944	4	0	3	120	15,133	4	0	3	121
				BLC	11,027	1	0	2	88	11,879	1	0	2	95	12,029	1	0	2	96
				LCCO	8,205	1	0	3	66	8,839	1	0	3	71	8,951	1	0	3	72
				RCCO	8,205	1	0	3	66	8,839	1	0	3	71	8,951	1	0	3	72
30	1400	P5	138W	T1S	14,679	3	0	3	106	15,814	3	0	3	115	16,014	3	0	3	116
				T2S	14,664	3	0	3	106	15,797	3	0	3	114	15,997	3	0	3	116
				T2M	14,739	3	0	3	107	15,878	3	0	3	115	16,079	3	0	3	117
				T3S	14,274	3	0	3	103	15,377	3	0	3	111	15,572	3	0	3	113
				T3M	14,704	2	0	3	107	15,840	3	0	3	115	16,040	3	0	3	116
				T4M	14,384	2	0	3	104	15,496	3	0	3	112	15,692	3	0	3	114
				TFTM	14,695	2	0	3	106	15,830	3	0	3	115	16,030	3	0	3	116
				TSVS	15,283	4	0	1	111	16,464	4	0	1	119	16,672	4	0	1	121
				T5S	15,295	3	0	1	111	16,477	4	0	1	119	16,686	4	0	1	121
				T5M	15,257	4	0	2	111	16,435	4	0	2	119	16,644	4	0	2	121
				TSW	15,157	4	0	3	110	16,328	4	0	3	118	16,534	4	0	3	120
				BLC	12,048	1	0	2	87	12,979	1	0	2	94	13,143	1	0	2	95
				LCCO	8,965	1	0	3	65	9,657	1	0	3	70	9,780	1	0	3	71
				RCCO	8,965	1	0	3	65	9,657	1	0	3	70	9,780	1	0	3	71



# Performance Data

## Lumen Output

Lumen values are from photometric tests performed in accordance with IESNA LM-79-08. Data is considered to be representative of the configurations shown, within the tolerances allowed by Lighting Facts. Contact factory for performance data on any configurations not shown here.

Forward Optics																			
LED Count	Drive Current	Power Package	System Watts	Dist. Type	30K (3000 K, 70 CRI)					40K (4000 K, 70 CRI)					50K (5000 K, 70 CRI)				
					Lumens	B	U	G	LPW	Lumens	B	U	G	LPW	Lumens	B	U	G	LPW
40	1250	P6	163W	T1S	17,654	3	0	3	108	19,018	3	0	3	117	19,259	3	0	3	118
				T2S	17,635	3	0	3	108	18,998	3	0	3	117	19,238	3	0	3	118
				T2M	17,726	3	0	3	109	19,096	3	0	3	117	19,337	3	0	3	119
				T3S	17,167	3	0	3	105	18,493	3	0	3	113	18,727	3	0	3	115
				T3M	17,683	3	0	3	108	19,049	3	0	3	117	19,290	3	0	3	118
				T4M	17,299	3	0	3	106	18,635	3	0	4	114	18,871	3	0	4	116
				TFTM	17,672	3	0	3	108	19,038	3	0	4	117	19,279	3	0	4	118
				TSVS	18,379	4	0	1	113	19,800	4	0	1	121	20,050	4	0	1	123
				T5S	18,394	4	0	2	113	19,816	4	0	2	122	20,066	4	0	2	123
				T5M	18,348	4	0	2	113	19,766	4	0	2	121	20,016	4	0	2	123
				TSW	18,228	5	0	3	112	19,636	5	0	3	120	19,885	5	0	3	122
				BLC	14,489	2	0	2	89	15,609	2	0	3	96	15,806	2	0	3	97
				LCCO	10,781	1	0	3	66	11,614	1	0	3	71	11,761	2	0	3	72
				RCCO	10,781	1	0	3	66	11,614	1	0	3	71	11,761	2	0	3	72
40	1400	P7	183W	T1S	19,227	3	0	3	105	20,712	3	0	3	113	20,975	3	0	3	115
				T2S	19,206	3	0	3	105	20,690	3	0	3	113	20,952	3	0	3	114
				T2M	19,305	3	0	3	105	20,797	3	0	3	114	21,060	3	0	3	115
				T3S	18,696	3	0	3	102	20,141	3	0	3	110	20,396	3	0	4	111
				T3M	19,258	3	0	3	105	20,746	3	0	3	113	21,009	3	0	3	115
				T4M	18,840	3	0	4	103	20,296	3	0	4	111	20,553	3	0	4	112
				TFTM	19,246	3	0	4	105	20,734	3	0	4	113	20,996	3	0	4	115
				TSVS	20,017	4	0	1	109	21,564	4	0	1	118	21,837	4	0	1	119
				T5S	20,033	4	0	2	109	21,581	4	0	2	118	21,854	4	0	2	119
				T5M	19,983	4	0	2	109	21,527	5	0	3	118	21,799	5	0	3	119
				TSW	19,852	5	0	3	108	21,386	5	0	3	117	21,656	5	0	3	118
				BLC	15,780	2	0	3	86	16,999	2	0	3	93	17,214	2	0	3	94
				LCCO	11,742	2	0	3	64	12,649	2	0	3	69	12,809	2	0	3	70
				RCCO	11,742	2	0	3	64	12,649	2	0	3	69	12,809	2	0	3	70
60	1050	P8	207W	T1S	22,490	3	0	3	109	24,228	3	0	3	117	24,535	3	0	3	119
				T2S	22,466	3	0	4	109	24,202	3	0	4	117	24,509	3	0	4	118
				T2M	22,582	3	0	3	109	24,327	3	0	3	118	24,635	3	0	3	119
				T3S	21,870	3	0	4	106	23,560	3	0	4	114	23,858	3	0	4	115
				T3M	22,527	3	0	4	109	24,268	3	0	4	117	24,575	3	0	4	119
				T4M	22,038	3	0	4	106	23,741	3	0	4	115	24,041	3	0	4	116
				TFTM	22,513	3	0	4	109	24,253	3	0	4	117	24,560	3	0	4	119
				TSVS	23,415	5	0	1	113	25,224	5	0	1	122	25,543	5	0	1	123
				T5S	23,434	4	0	2	113	25,244	4	0	2	122	25,564	4	0	2	123
				T5M	23,374	5	0	3	113	25,181	5	0	3	122	25,499	5	0	3	123
				TSW	23,221	5	0	4	112	25,016	5	0	4	121	25,332	5	0	4	122
				BLC	18,458	2	0	3	89	19,885	2	0	3	96	20,136	2	0	3	97
				LCCO	13,735	2	0	3	66	14,796	2	0	4	71	14,983	2	0	4	72
				RCCO	13,735	2	0	3	66	14,796	2	0	4	71	14,983	2	0	4	72
60	1250	P9	241W	T1S	25,575	3	0	3	106	27,551	3	0	3	114	27,900	3	0	3	116
				T2S	25,548	3	0	4	106	27,522	3	0	4	114	27,871	3	0	4	116
				T2M	25,680	3	0	3	107	27,664	3	0	3	115	28,014	3	0	3	116
				T3S	24,870	3	0	4	103	26,791	3	0	4	111	27,130	3	0	4	113
				T3M	25,617	3	0	4	106	27,597	3	0	4	115	27,946	3	0	4	116
				T4M	25,061	3	0	4	104	26,997	3	0	4	112	27,339	3	0	4	113
				TFTM	25,602	3	0	4	106	27,580	3	0	4	114	27,929	3	0	4	116
				TSVS	26,626	5	0	1	110	28,684	5	0	1	119	29,047	5	0	1	121
				T5S	26,648	4	0	2	111	28,707	5	0	2	119	29,070	5	0	2	121
				T5M	26,581	5	0	3	110	28,635	5	0	3	119	28,997	5	0	3	120
				TSW	26,406	5	0	4	110	28,447	5	0	4	118	28,807	5	0	4	120
				BLC	20,990	2	0	3	87	22,612	2	0	3	94	22,898	2	0	3	95
				LCCO	15,619	2	0	4	65	16,825	2	0	4	70	17,038	2	0	4	71
				RCCO	15,619	2	0	4	65	16,825	2	0	4	70	17,038	2	0	4	71

# Performance Data

## Lumen Output

Lumen values are from photometric tests performed in accordance with IESNA LM-79-08. Data is considered to be representative of the configurations shown, within the tolerances allowed by Lighting Facts. Contact factory for performance data on any configurations not shown here.

Rotated Optics																			
LED Count	Drive Current	Power Package	System Watts	Dist. Type	30K (3000 K, 70 CRI)					40K (4000 K, 70 CRI)					50K (5000 K, 70 CRI)				
					Lumens	B	U	G	LPW	Lumens	B	U	G	LPW	Lumens	B	U	G	LPW
60	530	P10	106W	T1S	13,042	3	0	3	123	14,050	3	0	3	133	14,228	3	0	3	134
				T2S	12,967	4	0	4	122	13,969	4	0	4	132	14,146	4	0	4	133
				T2M	13,201	3	0	3	125	14,221	3	0	3	134	14,401	3	0	3	136
				T3S	12,766	4	0	4	120	13,752	4	0	4	130	13,926	4	0	4	131
				T3M	13,193	4	0	4	124	14,213	4	0	4	134	14,393	4	0	4	136
				T4M	12,944	4	0	4	122	13,945	4	0	4	132	14,121	4	0	4	133
				TFTM	13,279	4	0	4	125	14,305	4	0	4	135	14,486	4	0	4	137
				TSVS	13,372	3	0	1	126	14,405	4	0	1	136	14,588	4	0	1	138
				T5S	13,260	3	0	1	125	14,284	3	0	1	135	14,465	3	0	1	136
				T5M	13,256	4	0	2	125	14,281	4	0	2	135	14,462	4	0	2	136
				TSW	13,137	4	0	3	124	14,153	4	0	3	134	14,332	4	0	3	135
				BLC	10,906	3	0	3	103	11,749	3	0	3	111	11,898	3	0	3	112
				LCCO	7,789	1	0	3	73	8,391	1	0	3	79	8,497	1	0	3	80
				RCCO	7,779	4	0	4	73	8,380	4	0	4	79	8,486	4	0	4	80
60	700	P11	137W	T1S	16,556	3	0	3	121	17,835	3	0	3	130	18,061	4	0	4	132
				T2S	16,461	4	0	4	120	17,733	4	0	4	129	17,957	4	0	4	131
				T2M	16,758	4	0	4	122	18,053	4	0	4	132	18,281	4	0	4	133
				T3S	16,205	4	0	4	118	17,457	4	0	4	127	17,678	4	0	4	129
				T3M	16,748	4	0	4	122	18,042	4	0	4	132	18,271	4	0	4	133
				T4M	16,432	4	0	4	120	17,702	4	0	4	129	17,926	4	0	4	131
				TFTM	16,857	4	0	4	123	18,159	4	0	4	133	18,389	4	0	4	134
				TSVS	16,975	4	0	1	124	18,287	4	0	1	133	18,518	4	0	1	135
				T5S	16,832	4	0	1	123	18,133	4	0	2	132	18,362	4	0	2	134
				T5M	16,828	4	0	2	123	18,128	4	0	2	132	18,358	4	0	2	134
				TSW	16,677	4	0	3	122	17,966	5	0	3	131	18,193	5	0	3	133
				BLC	13,845	3	0	3	101	14,915	3	0	3	109	15,103	3	0	3	110
				LCCO	9,888	1	0	3	72	10,652	2	0	3	78	10,787	2	0	3	79
				RCCO	9,875	4	0	4	72	10,638	4	0	4	78	10,773	4	0	4	79
60	1050	P12	207W	T1S	22,996	4	0	4	111	24,773	4	0	4	120	25,087	4	0	4	121
				T2S	22,864	4	0	4	110	24,631	5	0	5	119	24,943	5	0	5	120
				T2M	23,277	4	0	4	112	25,075	4	0	4	121	25,393	4	0	4	123
				T3S	22,509	4	0	4	109	24,248	5	0	5	117	24,555	5	0	5	119
				T3M	23,263	4	0	4	112	25,061	4	0	4	121	25,378	4	0	4	123
				T4M	22,824	5	0	5	110	24,588	5	0	5	119	24,899	5	0	5	120
				TFTM	23,414	5	0	5	113	25,223	5	0	5	122	25,543	5	0	5	123
				TSVS	23,579	5	0	1	114	25,401	5	0	1	123	25,722	5	0	1	124
				T5S	23,380	4	0	2	113	25,187	4	0	2	122	25,506	4	0	2	123
				T5M	23,374	5	0	3	113	25,181	5	0	3	122	25,499	5	0	3	123
				TSW	23,165	5	0	4	112	24,955	5	0	4	121	25,271	5	0	4	122
				BLC	19,231	4	0	4	93	20,717	4	0	4	100	20,979	4	0	4	101
				LCCO	13,734	2	0	3	66	14,796	2	0	4	71	14,983	2	0	4	72
				RCCO	13,716	4	0	4	66	14,776	4	0	4	71	14,963	4	0	4	72
60	1250	P13	231W	T1S	25,400	4	0	4	110	27,363	4	0	4	118	27,709	4	0	4	120
				T2S	25,254	5	0	5	109	27,205	5	0	5	118	27,550	5	0	5	119
				T2M	25,710	4	0	4	111	27,696	4	0	4	120	28,047	4	0	4	121
				T3S	24,862	5	0	5	108	26,783	5	0	5	116	27,122	5	0	5	117
				T3M	25,695	5	0	5	111	27,680	5	0	5	120	28,031	5	0	5	121
				T4M	25,210	5	0	5	109	27,158	5	0	5	118	27,502	5	0	5	119
				TFTM	25,861	5	0	5	112	27,860	5	0	5	121	28,212	5	0	5	122
				TSVS	26,043	5	0	1	113	28,056	5	0	1	121	28,411	5	0	1	123
				T5S	25,824	4	0	2	112	27,819	5	0	2	120	28,172	5	0	2	122
				T5M	25,818	5	0	3	112	27,813	5	0	3	120	28,165	5	0	3	122
				TSW	25,586	5	0	4	111	27,563	5	0	4	119	27,912	5	0	4	121
				BLC	21,241	4	0	4	92	22,882	4	0	4	99	23,172	4	0	4	100
				LCCO	15,170	2	0	4	66	16,342	2	0	4	71	16,549	2	0	4	72
				RCCO	15,150	5	0	5	66	16,321	5	0	5	71	16,527	5	0	5	72

## Capable Luminaire

This item is an A+ capable luminaire, which has been designed and tested to provide consistent color appearance and system-level interoperability.

- All configurations of this luminaire meet the Acuity Brands' specification for chromatic consistency
- This luminaire is A+ Certified when ordered with DTL® controls marked by a shaded background. DTL DLL equipped luminaires meet the A+ specification for luminaire to photocontrol interoperability<sup>1</sup>
- This luminaire is part of an A+ Certified solution for ROAM® or XPoint™ Wireless control networks, providing out-of-the-box control compatibility with simple commissioning, when ordered with drivers and control options marked by a shaded background<sup>1</sup>

To learn more about A+, visit [www.acuitybrands.com/aplus](http://www.acuitybrands.com/aplus).

1. See ordering tree for details.
2. A+ Certified Solutions for ROAM require the order of one ROAM node per luminaire. Sold Separately: [Link to Roam](#); [Link to DTL DLL](#)

## FEATURES & SPECIFICATIONS

### INTENDED USE

The sleek design of the D-Series Size 1 reflects the embedded high performance LED technology. It is ideal for many commercial and municipal applications, such as parking lots, plazas, campuses, and streetscapes.

### CONSTRUCTION

Single-piece die-cast aluminum housing has integral heat sink fins to optimize thermal management through conductive and convective cooling. Modular design allows for ease of maintenance and future light engine upgrades. The LED drivers are mounted in direct contact with the casting to promote low operating temperature and long life. Housing is completely sealed against moisture and environmental contaminants (IP65). Low EPA (1.01 ft<sup>2</sup>) for optimized pole wind loading.

### FINISH

Exterior parts are protected by a zinc-infused Super Durable TGIC thermoset powder coat finish that provides superior resistance to corrosion and weathering. A tightly controlled multi-stage process ensures a minimum 3 mils thickness for a finish that can withstand extreme climate changes without cracking or peeling. Available in both textured and non-textured finishes.

### OPTICS

Precision-molded proprietary acrylic lenses are engineered for superior area lighting distribution, uniformity, and pole spacing. Light engines are available in standard 3000 K, 4000 K and 5000 K (70 CRI) configurations. The D-Series Size 1 has zero uplight and qualifies as a Nighttime Friendly™ product, meaning it is consistent with the LEED® and Green Globes™ criteria for eliminating wasteful uplight.

### ELECTRICAL

Light engine configurations consist of high-efficacy LEDs mounted to metal-core circuit boards to maximize heat dissipation and promote long life (up to L85/100,000 hours at 25°C). Class 1 electronic drivers are designed to have a power factor >90%, THD <20%, and an expected life of 100,000 hours with <1% failure rate. Easily serviceable 10kV surge protection device meets a minimum Category C Low operation (per ANSI/IEEE C62.41.2).

### STANDARD CONTROLS

The DSX1 LED area luminaire has a number of control options. Dusk to dawn controls can be utilized via optional NEMA twist-lock photocell receptacles. Integrated motion sensors with on-board photocells feature field-adjustable programming and are suitable for mounting heights up to 30 feet.

### nLIGHT AIR CONTROLS

The DSX1 LED area luminaire is also available with nLight® AIR for the ultimate in wireless control. This powerful controls platform provides out-of-the-box basic motion sensing and photocontrol functionality and is suitable for mounting heights up to 40 feet. Once commissioned using a smartphone and the easy-to-use CLAIRITY app, nLight AIR equipped luminaires can be grouped, resulting in motion sensor and photocell group response without the need for additional equipment. Scheduled dimming with motion sensor over-ride can be achieved when used with the nLight Eclipse. Additional information about nLight Air can be found here.

### INSTALLATION

Included mounting block and integral arm facilitate quick and easy installation. Stainless steel bolts fasten the mounting block securely to poles and walls, enabling the D-Series Size 1 to withstand up to a 3.0 G vibration load rating per ANSI C136.31. The D-Series Size 1 utilizes the AERIS™ series pole drilling pattern (template #8). NEMA photocontrol receptacle are also available.

### LISTINGS

UL Listed for wet locations. Light engines are IP66 rated; luminaire is IP65 rated. Rated for -40°C minimum ambient. U.S. Patent No. D672,492 S. International patent pending.

DesignLights Consortium® (DLC) Premium qualified product and DLC qualified product.

Not all versions of this product may be DLC Premium qualified or DLC qualified. Please check the DLC Qualified Products List at [www.designlights.org/QPL](http://www.designlights.org/QPL) to confirm which versions are qualified.

International Dark-Sky Association (IDA) Fixture Seal of Approval (FSA) is available for all products on this page utilizing 3000K color temperature only.

### WARRANTY

5-year limited warranty. Complete warranty terms located at: [www.acuitybrands.com/CustomerResources/Terms\\_and\\_conditions.aspx](http://www.acuitybrands.com/CustomerResources/Terms_and_conditions.aspx)

**Note:** Actual performance may differ as a result of end-user environment and application.

All values are design or typical values, measured under laboratory conditions at 25 °C.

Specifications subject to change without notice.







# D-Series Size 1 LED Area Luminaire

d#series



Catalog Number
Notes
Type

Hit the Tab key or mouse over the page to see all interactive elements.

## Specifications

<b>EPA:</b>	1.01 ft <sup>2</sup> (0.09 m <sup>2</sup> )
<b>Length:</b>	33" (83.8 cm)
<b>Width:</b>	13" (33.0 cm)
<b>Height H1:</b>	7-1/2" (19.0 cm)
<b>Height H2:</b>	3-1/2"
<b>Weight (max):</b>	27 lbs (12.2 kg)

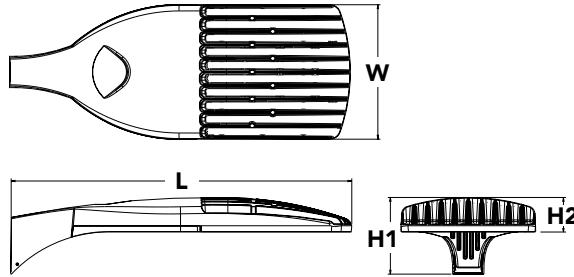

## Introduction

The modern styling of the D-Series is striking yet unobtrusive - making a bold, progressive statement even as it blends seamlessly with its environment. The D-Series distills the benefits of the latest in LED technology into a high performance, high efficacy, long-life luminaire.

The outstanding photometric performance results in sites with excellent uniformity, greater pole spacing and lower power density. It is ideal for replacing up to 750W metal halide in pedestrian and area lighting applications with typical energy savings of 65% and expected service life of over 100,000 hours.

A+ Capable options indicated by this color background.

## Ordering Information

**EXAMPLE:** DSX1 LED P7 40K T3M MVOLT SPA NLTAIR2 PIRHN DDBXD

DSX1 LED		Color temperature		Distribution		Voltage	Mounting		
Series	LEDs								
<b>DSX1 LED</b>	<b>Forward optics</b>	30K	3000 K	T1S	Type I short	T5VS	Type V very short	<b>MVOLT<sup>3</sup></b>	<b>Shipped included</b>
	P1 <b>P4</b> P7	40K	4000 K	<b>T2S</b>	Type II short	T5S	Type V short	120 <sup>4</sup>	<b>SPA</b> <b>Square pole mounting</b>
	P2 P5 P8	<b>50K</b>	<b>5000 K</b>	T2M	Type II medium	T5M	Type V medium	208 <sup>4</sup>	RPA Round pole mounting
	P3 P6 P9			T3S	Type III short	T5W	Type V wide	240 <sup>4</sup>	WBA Wall bracket
	<b>Rotated optics</b>			T3M	Type III medium	BLC	Backlight control <sup>2</sup>	277 <sup>4</sup>	SPUMBA Square pole universal mounting adaptor <sup>6</sup>
	P10 <sup>1</sup> P12 <sup>1</sup>			T4M	Type IV medium	LCCO	Left corner cutoff <sup>2</sup>	347 <sup>4,5</sup>	RPUMBA Round pole universal mounting adaptor <sup>6</sup>
	P11 <sup>1</sup> P13 <sup>1</sup>			TFTM	Forward throw medium	RCCO	Right corner cutoff <sup>2</sup>	480 <sup>4,5</sup>	<b>Shipped separately</b>
									KMA8 DDBXD U Mast arm mounting bracket adaptor (specify finish) <sup>7</sup>

Control options	Other options	Finish (required)
<b>Shipped installed</b>	<b>Shipped installed</b>	DDBXD Dark bronze
NLTAIR2 nLight AIR generation 2 enabled <sup>8</sup>	HS House-side shield <sup>17</sup>	DBLXD Black
PIRHN Network, high/low motion/ambient sensor <sup>9</sup>	SF Single fuse (120, 277, 347V) <sup>4</sup>	DNAXD Natural aluminum
PER NEMA twist-lock receptacle only (controls ordered separate) <sup>10</sup>	DF Double fuse (208, 240, 480V) <sup>4</sup>	DWHXD White
PER5 Five-pin receptacle only (controls ordered separate) <sup>10,11</sup>	L90 Left rotated optics <sup>1</sup>	DBBTD Textured dark bronze
PER7 Seven-pin receptacle only (controls ordered separate) <sup>10,11</sup>	R90 Right rotated optics <sup>1</sup>	DBLBXD Textured black
DMG 0-10v dimming wires pulled outside fixture (for use with an external control, ordered separately) <sup>12</sup>	<b>Shipped separately</b>	DNATXD Textured natural aluminum
DS Dual switching <sup>12,13,14</sup>	BS Bird spikes <sup>18</sup>	DWHGXD Textured white
	EGS External glare shield <sup>18</sup>	
PIR High/low, motion/ambient sensor, 8-15' mounting height, ambient sensor enabled at 5fc <sup>15,16</sup>		
PIRH High/low, motion/ambient sensor, 15-30' mounting height, ambient sensor enabled at 5fc <sup>15,16</sup>		
PIR1FC3V High/low, motion/ambient sensor, 8-15' mounting height, ambient sensor enabled at 1fc <sup>15,16</sup>		
PIRH1FC3V Bi-level, motion/ambient sensor, 15-30' mounting height, ambient sensor enabled at 1fc <sup>15,16</sup>		
FAO Field adjustable output <sup>14</sup>		



## Ordering Information

### Accessories

Ordered and shipped separately.

DLL127F 1.5 JU	Photocell - SSL twist-lock (120-277V) <sup>19</sup>
DLL347F 1.5 CUL JU	Photocell - SSL twist-lock (347V) <sup>19</sup>
DLL480F 1.5 CUL JU	Photocell - SSL twist-lock (480V) <sup>19</sup>
DSHORT SBK U	Shorting cap <sup>19</sup>
DSX1HS 30C U	House-side shield for P1, P2, P3, P4 and P5 <sup>17</sup>
DSX1HS 40C U	House-side shield for P6 and P7 <sup>17</sup>
DSX1HS 60C U	House-side shield for P8, P9, P10, P11 and P12 <sup>17</sup>
PUMBA DDBXD U*	Square and round pole universal mounting bracket (specify finish) <sup>20</sup>
KMA8 DDBXD U	Mast arm mounting bracket adaptor (specify finish) <sup>6</sup>

For more control options, visit [DTL](#) and [ROAM](#) online.

### NOTES

- P10, P11, P12 or P13 and rotated optics (L90, R90) only available together.
- Not available with HS.
- MVOLT driver operates on any line voltage from 120-277V (50/60 Hz).
- Single fuse (SF) requires 120V, 277V or 347V. Double fuse (DF) requires 208V, 240V or 480V.
- Not available in P1 or P10.
- Universal mounting brackets intended for retrofit on existing, pre-drilled poles only. 1.5 G vibration load rating per ANCI C136.31.
- Must order fixture with SPA option. Must be ordered as a separate accessory; see Accessories information. For use with 2-3/8" mast arm (not included).
- Must be ordered with PIRHN. Sensor cover available only in dark bronze, black, white and natural aluminum colors.
- Must be ordered with NLTAIR2. For more information on nLight Air 2 visit [this link](#).
- Photocell ordered and shipped as a separate line item from Acuity Brands Controls. See accessories. Not available with DS option. Shorting cap included.
- If ROAM<sup>®</sup> node required, it must be ordered and shipped as a separate line item from Acuity Brands Controls. Node with integral dimming.
- Provides 50/50 fixture operation via (2) independent drivers. Not available with PER, PER5, PER7, PIR or PIRH. Not available P1, P2, P3, P4 or P5.
- Requires (2) separately switched circuits with isolated neutral. See Outdoor Control Technical Guide for details.
- Reference Motion Sensor table on page 4.
- Reference controls options table on page 4 to see functionality.
- Not available with other dimming controls options
- Not available with BLC, LCCO and RCCO distribution. Also available as a separate accessory; see Accessories information.
- Must be ordered with fixture for factory pre-drilling.
- Requires luminaire to be specified with PER, PER5 or PER7 option. See PER Table on page 3.
- For retrofit use only.

## Options

### EGS - External Glare Shield

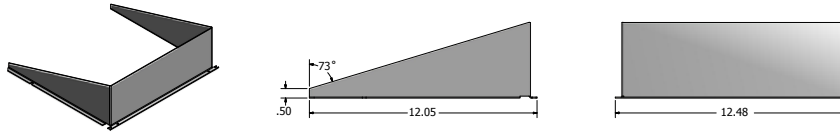

## Drilling

### HANDHOLE ORIENTATION

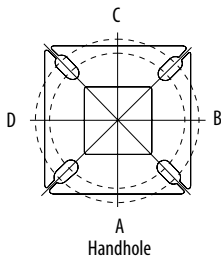

### Tenon Mounting Slipfitter\*\*

Tenon O.D.	Mounting	Single Unit	2 @ 180	2 @ 90	3 @ 120	3 @ 90	4 @ 90
2-3/8"	SPA/RPA	AS3-5 190	AS3-5 280	AS3-5 290	AS3-5 320	AS3-5 390	AS3-5 490
	SPUMBA	AS3-5 190	AS3-5 280	AS4-5 290	AS3-5 320	AS4-5 390	AS4-5 490
	RUPUMBA	AS3-5 190	AS3-5 280		AS3-5 320		
2-7/8"	SPA/RPA	AST25-190	AST25-280	AST25-290	AST25-320	AST25-390	AST25-490
	SPUMBA	AST25-190	AST25-280		AST25-320		
	RUPUMBA	AST25-190	AST25-280		AST25-320		
4"	SPA/RPA	AST35-190	AST35-280	AST35-290	AST35-320	AST35-390	AST35-490
	SPUMBA	AST35-190	AST35-280	AST35-290	AST35-320	AST35-390	AST35-490
	RUPUMBA	AST35-190	AST35-280		AST35-320		

Template #8

Top of Pole

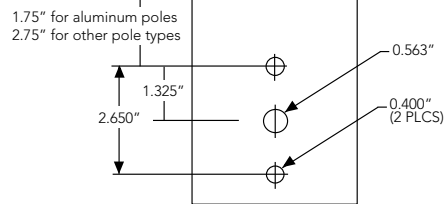

Mounting Option	Drilling Template	Single	2 @ 180	2 @ 90	3 @ 90	3 @ 120	4 @ 90
Head Location		Side B	Side B & D	Side B & C	Side B, C & D	Round Pole Only	Side A, B, C & D
Drill Nomenclature	#8	DM19AS	DM28AS	DM29AS	DM39AS	DM32AS	DM49AS

	Drilling Template	Minimum Acceptable Outside Pole Dimension					
SPA	#8	2-7/8"	2-7/8"	3.5"	3.5"	3"	3.5"
RPA	#8	2-7/8"	2-7/8"	3.5"	3.5"	3"	3.5"
SPUMBA	#5	2-7/8"	3"	4"	4"	3.5"	4"
RPUMBA	#5	2-7/8"	3.5"	5"	5"	3.5"	5"

# Photometric Diagrams

To see complete photometric reports or download .ies files for this product, visit Lithonia Lighting's [D-Series Area Size 1 homepage](#).

Isofootcandle plots for the DSX1 LED 60C 1000 40K. Distances are in units of mounting height (25').

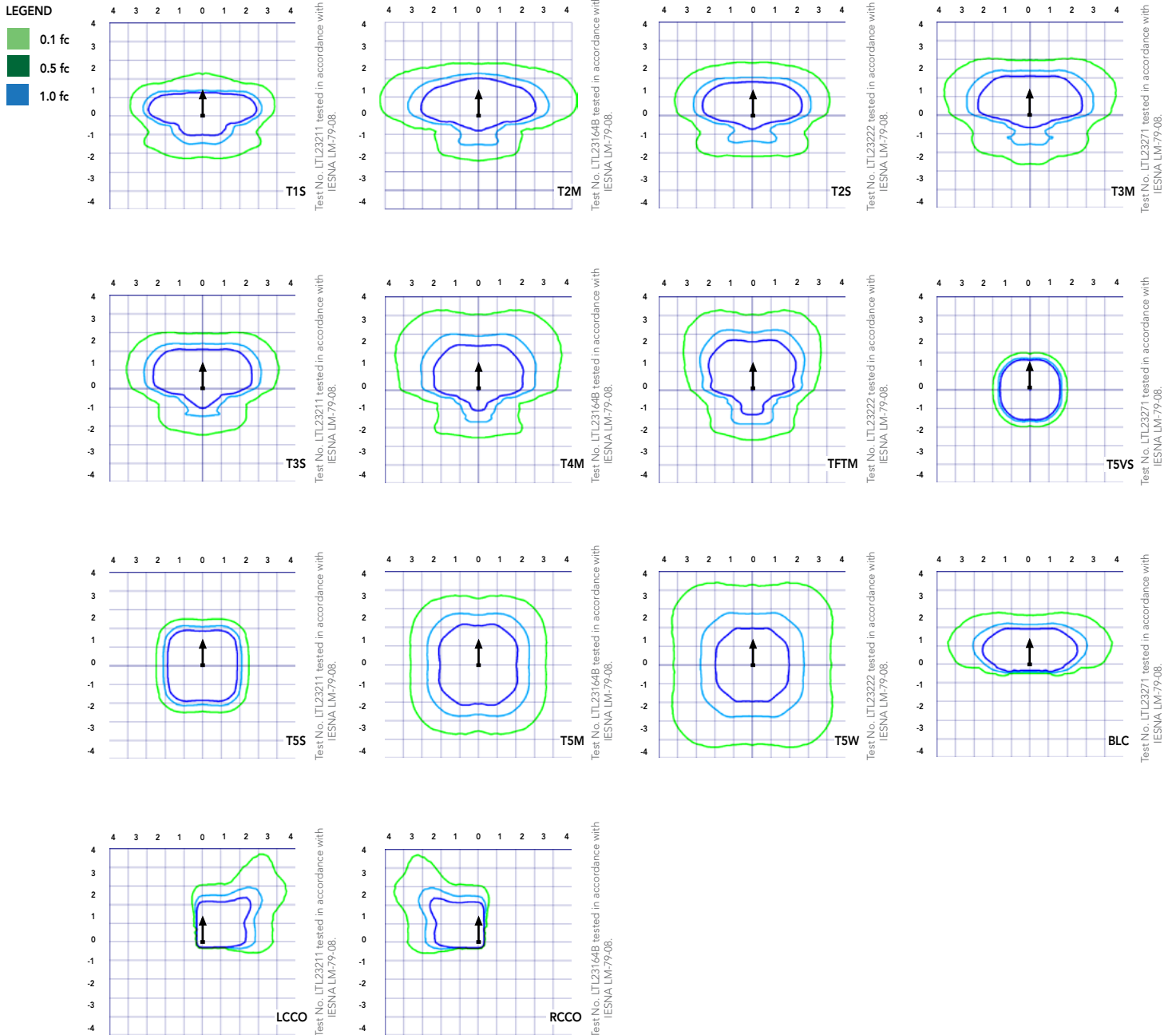

## Performance Data

### Lumen Ambient Temperature (LAT) Multipliers

Use these factors to determine relative lumen output for average ambient temperatures from 0-40°C (32-104°F).

Ambient		Lumen Multiplier
0°C	32°F	1.04
5°C	41°F	1.04
10°C	50°F	1.03
15°C	59°F	1.02
20°C	68°F	1.01
<b>25°C</b>	<b>77°F</b>	<b>1.00</b>
30°C	86°F	0.99
35°C	95°F	0.98
40°C	104°F	0.97

### Projected LED Lumen Maintenance

Data references the extrapolated performance projections for the platforms noted in a **25°C ambient**, based on 10,000 hours of LED testing (tested per IESNA LM-80-08 and projected per IESNA TM-21-11).

To calculate LLF, use the lumen maintenance factor that corresponds to the desired number of operating hours below. For other lumen maintenance values, contact factory.

Operating Hours	Lumen Maintenance Factor
0	1.00
25,000	0.96
50,000	0.92
100,000	0.85

#### Motion Sensor Default Settings

Option	Dimmed State	High Level (when triggered)	Photocell Operation	Dwell Time	Ramp-up Time	Ramp-down Time
PIR or PIRH	3V (37%) Output	10V (100%) Output	Enabled @ 5FC	5 min	3 sec	5 min
*PIR1FC3V or PIRH1FC3V	3V (37%) Output	10V (100%) Output	Enabled @ 1FC	5 min	3 sec	5 min

\*for use when motion sensor is used as dusk to dawn control.

### Electrical Load

	Performance Package	LED Count	Drive Current	Wattage	Current (A)					
					120	208	240	277	347	480
Forward Optics (Non-Rotated)	P1	30	530	54	0.45	0.26	0.23	0.19	0.10	0.12
	P2	30	700	70	0.59	0.34	0.30	0.25	0.20	0.16
	P3	30	1050	102	0.86	0.50	0.44	0.38	0.30	0.22
	P4	30	1250	125	1.06	0.60	0.52	0.46	0.37	0.27
	P5	30	1400	138	1.16	0.67	0.58	0.51	0.40	0.29
	P6	40	1250	163	1.36	0.78	0.68	0.59	0.47	0.34
	P7	40	1400	183	1.53	0.88	0.76	0.66	0.53	0.38
	P8	60	1050	207	1.74	0.98	0.87	0.76	0.64	0.49
	P9	60	1250	241	2.01	1.16	1.01	0.89	0.70	0.51
Rotated Optics (Requires L90 or R90)	P10	60	530	106	0.90	0.52	0.47	0.43	0.33	0.27
	P11	60	700	137	1.15	0.67	0.60	0.53	0.42	0.32
	P12	60	1050	207	1.74	0.99	0.87	0.76	0.60	0.46
	P13	60	1250	231	1.93	1.12	0.97	0.86	0.67	0.49

#### Controls Options

Nomenclature	Description	Functionality	Primary control device	Notes
FA0	Field adjustable output device installed inside the luminaire; wired to the driver dimming leads.	Allows the luminaire to be manually dimmed, effectively trimming the light output.	FA0 device	Cannot be used with other controls options that need the 0-10V leads
DS	Drivers wired independently for 50/50 luminaire operation	The luminaire is wired to two separate circuits, allowing for 50/50 operation.	Independently wired drivers	Requires two separately switched circuits. Consider nLight AIR as a more cost effective alternative.
PERS or PER7	Twist-lock photocell receptacle	Compatible with standard twist-lock photocells for dusk to dawn operation, or advanced control nodes that provide 0-10V dimming signals.	Twist-lock photocells such as DLL Elite or advanced control nodes such as ROAM.	Pins 4 & 5 to dimming leads on driver, Pins 6 & 7 are capped inside luminaire
PIR or PIRH	Motion sensors with integral photocell. PIR for 8-15' mounting; PIRH for 15-30' mounting	Luminaires dim when no occupancy is detected.	Acuity Controls SBOR	Also available with PIRH1FC3V when the sensor photocell is used for dusk-to-dawn operation.
NLTAIR2 PIRHN	nLight AIR enabled luminaire for motion sensing, photocell and wireless communication.	Motion and ambient light sensing with group response. Scheduled dimming with motion sensor over-ride when wirelessly connected to the nLight Eclipse.	nLight Air rSDGR	nLight AIR sensors can be programmed and commissioned from the ground using the CIAIRity Pro app.

# Performance Data

## Lumen Output

Lumen values are from photometric tests performed in accordance with IESNA LM-79-08. Data is considered to be representative of the configurations shown, within the tolerances allowed by Lighting Facts Contact factory for performance data on any configurations not shown here.

Forward Optics																			
LED Count	Drive Current	Power Package	System Watts	Dist. Type	30K (3000 K, 70 CRI)					40K (4000 K, 70 CRI)					50K (5000 K, 70 CRI)				
					Lumens	B	U	G	LPW	Lumens	B	U	G	LPW	Lumens	B	U	G	LPW
30	530	P1	54W	T1S	6,457	2	0	2	120	6,956	2	0	2	129	7,044	2	0	2	130
				T2S	6,450	2	0	2	119	6,949	2	0	2	129	7,037	2	0	2	130
				T2M	6,483	1	0	1	120	6,984	2	0	2	129	7,073	2	0	2	131
				T3S	6,279	2	0	2	116	6,764	2	0	2	125	6,850	2	0	2	127
				T3M	6,468	1	0	2	120	6,967	1	0	2	129	7,056	1	0	2	131
				T4M	6,327	1	0	2	117	6,816	1	0	2	126	6,902	1	0	2	128
				TFTM	6,464	1	0	2	120	6,963	1	0	2	129	7,051	1	0	2	131
				TSVS	6,722	2	0	0	124	7,242	3	0	0	134	7,334	3	0	0	136
				T5S	6,728	2	0	1	125	7,248	2	0	1	134	7,340	2	0	1	136
				T5M	6,711	3	0	1	124	7,229	3	0	1	134	7,321	3	0	2	136
				TSW	6,667	3	0	2	123	7,182	3	0	2	133	7,273	3	0	2	135
				BLC	5,299	1	0	1	98	5,709	1	0	2	106	5,781	1	0	2	107
				LCCO	3,943	1	0	2	73	4,248	1	0	2	79	4,302	1	0	2	80
				RCCO	3,943	1	0	2	73	4,248	1	0	2	79	4,302	1	0	2	80
30	700	P2	70W	T1S	8,249	2	0	2	118	8,886	2	0	2	127	8,999	2	0	2	129
				T2S	8,240	2	0	2	118	8,877	2	0	2	127	8,989	2	0	2	128
				T2M	8,283	2	0	2	118	8,923	2	0	2	127	9,036	2	0	2	129
				T3S	8,021	2	0	2	115	8,641	2	0	2	123	8,751	2	0	2	125
				T3M	8,263	2	0	2	118	8,901	2	0	2	127	9,014	2	0	2	129
				T4M	8,083	2	0	2	115	8,708	2	0	2	124	8,818	2	0	2	126
				TFTM	8,257	2	0	2	118	8,896	2	0	2	127	9,008	2	0	2	129
				TSVS	8,588	3	0	0	123	9,252	3	0	0	132	9,369	3	0	0	134
				T5S	8,595	3	0	1	123	9,259	3	0	1	132	9,376	3	0	1	134
				T5M	8,573	3	0	2	122	9,236	3	0	2	132	9,353	3	0	2	134
				TSW	8,517	3	0	2	122	9,175	4	0	2	131	9,291	4	0	2	133
				BLC	6,770	1	0	2	97	7,293	1	0	2	104	7,386	1	0	2	106
				LCCO	5,038	1	0	2	72	5,427	1	0	2	78	5,496	1	0	2	79
				RCCO	5,038	1	0	2	72	5,427	1	0	2	78	5,496	1	0	2	79
30	1050	P3	102W	T1S	11,661	2	0	2	114	12,562	3	0	3	123	12,721	3	0	3	125
				T2S	11,648	2	0	2	114	12,548	3	0	3	123	12,707	3	0	3	125
				T2M	11,708	2	0	2	115	12,613	2	0	2	124	12,773	2	0	2	125
				T3S	11,339	2	0	2	111	12,215	3	0	3	120	12,370	3	0	3	121
				T3M	11,680	2	0	2	115	12,582	2	0	2	123	12,742	2	0	2	125
				T4M	11,426	2	0	3	112	12,309	2	0	3	121	12,465	2	0	3	122
				TFTM	11,673	2	0	2	114	12,575	2	0	3	123	12,734	2	0	3	125
				TSVS	12,140	3	0	1	119	13,078	3	0	1	128	13,244	3	0	1	130
				T5S	12,150	3	0	1	119	13,089	3	0	1	128	13,254	3	0	1	130
				T5M	12,119	4	0	2	119	13,056	4	0	2	128	13,221	4	0	2	130
				TSW	12,040	4	0	3	118	12,970	4	0	3	127	13,134	4	0	3	129
				BLC	9,570	1	0	2	94	10,310	1	0	2	101	10,440	1	0	2	102
				LCCO	7,121	1	0	3	70	7,671	1	0	3	75	7,768	1	0	3	76
				RCCO	7,121	1	0	3	70	7,671	1	0	3	75	7,768	1	0	3	76
30	1250	P4	125W	T1S	13,435	3	0	3	107	14,473	3	0	3	116	14,657	3	0	3	117
				T2S	13,421	3	0	3	107	14,458	3	0	3	116	14,641	3	0	3	117
				T2M	13,490	2	0	2	108	14,532	3	0	3	116	14,716	3	0	3	118
				T3S	13,064	3	0	3	105	14,074	3	0	3	113	14,252	3	0	3	114
				T3M	13,457	2	0	2	108	14,497	2	0	2	116	14,681	2	0	2	117
				T4M	13,165	2	0	3	105	14,182	2	0	3	113	14,362	2	0	3	115
				TFTM	13,449	2	0	3	108	14,488	2	0	3	116	14,672	2	0	3	117
				TSVS	13,987	4	0	1	112	15,068	4	0	1	121	15,259	4	0	1	122
				T5S	13,999	3	0	1	112	15,080	3	0	1	121	15,271	3	0	1	122
				T5M	13,963	4	0	2	112	15,042	4	0	2	120	15,233	4	0	2	122
				TSW	13,872	4	0	3	111	14,944	4	0	3	120	15,133	4	0	3	121
				BLC	11,027	1	0	2	88	11,879	1	0	2	95	12,029	1	0	2	96
				LCCO	8,205	1	0	3	66	8,839	1	0	3	71	8,951	1	0	3	72
				RCCO	8,205	1	0	3	66	8,839	1	0	3	71	8,951	1	0	3	72
30	1400	P5	138W	T1S	14,679	3	0	3	106	15,814	3	0	3	115	16,014	3	0	3	116
				T2S	14,664	3	0	3	106	15,797	3	0	3	114	15,997	3	0	3	116
				T2M	14,739	3	0	3	107	15,878	3	0	3	115	16,079	3	0	3	117
				T3S	14,274	3	0	3	103	15,377	3	0	3	111	15,572	3	0	3	113
				T3M	14,704	2	0	3	107	15,840	3	0	3	115	16,040	3	0	3	116
				T4M	14,384	2	0	3	104	15,496	3	0	3	112	15,692	3	0	3	114
				TFTM	14,695	2	0	3	106	15,830	3	0	3	115	16,030	3	0	3	116
				TSVS	15,283	4	0	1	111	16,464	4	0	1	119	16,672	4	0	1	121
				T5S	15,295	3	0	1	111	16,477	4	0	1	119	16,686	4	0	1	121
				T5M	15,257	4	0	2	111	16,435	4	0	2	119	16,644	4	0	2	121
				TSW	15,157	4	0	3	110	16,328	4	0	3	118	16,534	4	0	3	120
				BLC	12,048	1	0	2	87	12,979	1	0	2	94	13,143	1	0	2	95
				LCCO	8,965	1	0	3	65	9,657	1	0	3	70	9,780	1	0	3	71
				RCCO	8,965	1	0	3	65	9,657	1	0	3	70	9,780	1	0	3	71



# Performance Data

## Lumen Output

Lumen values are from photometric tests performed in accordance with IESNA LM-79-08. Data is considered to be representative of the configurations shown, within the tolerances allowed by Lighting Facts. Contact factory for performance data on any configurations not shown here.

Forward Optics																			
LED Count	Drive Current	Power Package	System Watts	Dist. Type	30K (3000 K, 70 CRI)					40K (4000 K, 70 CRI)					50K (5000 K, 70 CRI)				
					Lumens	B	U	G	LPW	Lumens	B	U	G	LPW	Lumens	B	U	G	LPW
40	1250	P6	163W	T1S	17,654	3	0	3	108	19,018	3	0	3	117	19,259	3	0	3	118
				T2S	17,635	3	0	3	108	18,998	3	0	3	117	19,238	3	0	3	118
				T2M	17,726	3	0	3	109	19,096	3	0	3	117	19,337	3	0	3	119
				T3S	17,167	3	0	3	105	18,493	3	0	3	113	18,727	3	0	3	115
				T3M	17,683	3	0	3	108	19,049	3	0	3	117	19,290	3	0	3	118
				T4M	17,299	3	0	3	106	18,635	3	0	4	114	18,871	3	0	4	116
				TFTM	17,672	3	0	3	108	19,038	3	0	4	117	19,279	3	0	4	118
				TSVS	18,379	4	0	1	113	19,800	4	0	1	121	20,050	4	0	1	123
				T5S	18,394	4	0	2	113	19,816	4	0	2	122	20,066	4	0	2	123
				T5M	18,348	4	0	2	113	19,766	4	0	2	121	20,016	4	0	2	123
				TSW	18,228	5	0	3	112	19,636	5	0	3	120	19,885	5	0	3	122
				BLC	14,489	2	0	2	89	15,609	2	0	3	96	15,806	2	0	3	97
				LCCO	10,781	1	0	3	66	11,614	1	0	3	71	11,761	2	0	3	72
				RCCO	10,781	1	0	3	66	11,614	1	0	3	71	11,761	2	0	3	72
40	1400	P7	183W	T1S	19,227	3	0	3	105	20,712	3	0	3	113	20,975	3	0	3	115
				T2S	19,206	3	0	3	105	20,690	3	0	3	113	20,952	3	0	3	114
				T2M	19,305	3	0	3	105	20,797	3	0	3	114	21,060	3	0	3	115
				T3S	18,696	3	0	3	102	20,141	3	0	3	110	20,396	3	0	4	111
				T3M	19,258	3	0	3	105	20,746	3	0	3	113	21,009	3	0	3	115
				T4M	18,840	3	0	4	103	20,296	3	0	4	111	20,553	3	0	4	112
				TFTM	19,246	3	0	4	105	20,734	3	0	4	113	20,996	3	0	4	115
				TSVS	20,017	4	0	1	109	21,564	4	0	1	118	21,837	4	0	1	119
				T5S	20,033	4	0	2	109	21,581	4	0	2	118	21,854	4	0	2	119
				T5M	19,983	4	0	2	109	21,527	5	0	3	118	21,799	5	0	3	119
				TSW	19,852	5	0	3	108	21,386	5	0	3	117	21,656	5	0	3	118
				BLC	15,780	2	0	3	86	16,999	2	0	3	93	17,214	2	0	3	94
				LCCO	11,742	2	0	3	64	12,649	2	0	3	69	12,809	2	0	3	70
				RCCO	11,742	2	0	3	64	12,649	2	0	3	69	12,809	2	0	3	70
60	1050	P8	207W	T1S	22,490	3	0	3	109	24,228	3	0	3	117	24,535	3	0	3	119
				T2S	22,466	3	0	4	109	24,202	3	0	4	117	24,509	3	0	4	118
				T2M	22,582	3	0	3	109	24,327	3	0	3	118	24,635	3	0	3	119
				T3S	21,870	3	0	4	106	23,560	3	0	4	114	23,858	3	0	4	115
				T3M	22,527	3	0	4	109	24,268	3	0	4	117	24,575	3	0	4	119
				T4M	22,038	3	0	4	106	23,741	3	0	4	115	24,041	3	0	4	116
				TFTM	22,513	3	0	4	109	24,253	3	0	4	117	24,560	3	0	4	119
				TSVS	23,415	5	0	1	113	25,224	5	0	1	122	25,543	5	0	1	123
				T5S	23,434	4	0	2	113	25,244	4	0	2	122	25,564	4	0	2	123
				T5M	23,374	5	0	3	113	25,181	5	0	3	122	25,499	5	0	3	123
				TSW	23,221	5	0	4	112	25,016	5	0	4	121	25,332	5	0	4	122
				BLC	18,458	2	0	3	89	19,885	2	0	3	96	20,136	2	0	3	97
				LCCO	13,735	2	0	3	66	14,796	2	0	4	71	14,983	2	0	4	72
				RCCO	13,735	2	0	3	66	14,796	2	0	4	71	14,983	2	0	4	72
60	1250	P9	241W	T1S	25,575	3	0	3	106	27,551	3	0	3	114	27,900	3	0	3	116
				T2S	25,548	3	0	4	106	27,522	3	0	4	114	27,871	3	0	4	116
				T2M	25,680	3	0	3	107	27,664	3	0	3	115	28,014	3	0	3	116
				T3S	24,870	3	0	4	103	26,791	3	0	4	111	27,130	3	0	4	113
				T3M	25,617	3	0	4	106	27,597	3	0	4	115	27,946	3	0	4	116
				T4M	25,061	3	0	4	104	26,997	3	0	4	112	27,339	3	0	4	113
				TFTM	25,602	3	0	4	106	27,580	3	0	4	114	27,929	3	0	4	116
				TSVS	26,626	5	0	1	110	28,684	5	0	1	119	29,047	5	0	1	121
				T5S	26,648	4	0	2	111	28,707	5	0	2	119	29,070	5	0	2	121
				T5M	26,581	5	0	3	110	28,635	5	0	3	119	28,997	5	0	3	120
				TSW	26,406	5	0	4	110	28,447	5	0	4	118	28,807	5	0	4	120
				BLC	20,990	2	0	3	87	22,612	2	0	3	94	22,898	2	0	3	95
				LCCO	15,619	2	0	4	65	16,825	2	0	4	70	17,038	2	0	4	71
				RCCO	15,619	2	0	4	65	16,825	2	0	4	70	17,038	2	0	4	71

# Performance Data

## Lumen Output

Lumen values are from photometric tests performed in accordance with IESNA LM-79-08. Data is considered to be representative of the configurations shown, within the tolerances allowed by Lighting Facts. Contact factory for performance data on any configurations not shown here.

Rotated Optics																			
LED Count	Drive Current	Power Package	System Watts	Dist. Type	30K (3000 K, 70 CRI)					40K (4000 K, 70 CRI)					50K (5000 K, 70 CRI)				
					Lumens	B	U	G	LPW	Lumens	B	U	G	LPW	Lumens	B	U	G	LPW
60	530	P10	106W	T1S	13,042	3	0	3	123	14,050	3	0	3	133	14,228	3	0	3	134
				T2S	12,967	4	0	4	122	13,969	4	0	4	132	14,146	4	0	4	133
				T2M	13,201	3	0	3	125	14,221	3	0	3	134	14,401	3	0	3	136
				T3S	12,766	4	0	4	120	13,752	4	0	4	130	13,926	4	0	4	131
				T3M	13,193	4	0	4	124	14,213	4	0	4	134	14,393	4	0	4	136
				T4M	12,944	4	0	4	122	13,945	4	0	4	132	14,121	4	0	4	133
				TFTM	13,279	4	0	4	125	14,305	4	0	4	135	14,486	4	0	4	137
				TSVS	13,372	3	0	1	126	14,405	4	0	1	136	14,588	4	0	1	138
				T5S	13,260	3	0	1	125	14,284	3	0	1	135	14,465	3	0	1	136
				T5M	13,256	4	0	2	125	14,281	4	0	2	135	14,462	4	0	2	136
				TSW	13,137	4	0	3	124	14,153	4	0	3	134	14,332	4	0	3	135
				BLC	10,906	3	0	3	103	11,749	3	0	3	111	11,898	3	0	3	112
				LCCO	7,789	1	0	3	73	8,391	1	0	3	79	8,497	1	0	3	80
				RCCO	7,779	4	0	4	73	8,380	4	0	4	79	8,486	4	0	4	80
60	700	P11	137W	T1S	16,556	3	0	3	121	17,835	3	0	3	130	18,061	4	0	4	132
				T2S	16,461	4	0	4	120	17,733	4	0	4	129	17,957	4	0	4	131
				T2M	16,758	4	0	4	122	18,053	4	0	4	132	18,281	4	0	4	133
				T3S	16,205	4	0	4	118	17,457	4	0	4	127	17,678	4	0	4	129
				T3M	16,748	4	0	4	122	18,042	4	0	4	132	18,271	4	0	4	133
				T4M	16,432	4	0	4	120	17,702	4	0	4	129	17,926	4	0	4	131
				TFTM	16,857	4	0	4	123	18,159	4	0	4	133	18,389	4	0	4	134
				TSVS	16,975	4	0	1	124	18,287	4	0	1	133	18,518	4	0	1	135
				T5S	16,832	4	0	1	123	18,133	4	0	2	132	18,362	4	0	2	134
				T5M	16,828	4	0	2	123	18,128	4	0	2	132	18,358	4	0	2	134
				TSW	16,677	4	0	3	122	17,966	5	0	3	131	18,193	5	0	3	133
				BLC	13,845	3	0	3	101	14,915	3	0	3	109	15,103	3	0	3	110
				LCCO	9,888	1	0	3	72	10,652	2	0	3	78	10,787	2	0	3	79
				RCCO	9,875	4	0	4	72	10,638	4	0	4	78	10,773	4	0	4	79
60	1050	P12	207W	T1S	22,996	4	0	4	111	24,773	4	0	4	120	25,087	4	0	4	121
				T2S	22,864	4	0	4	110	24,631	5	0	5	119	24,943	5	0	5	120
				T2M	23,277	4	0	4	112	25,075	4	0	4	121	25,393	4	0	4	123
				T3S	22,509	4	0	4	109	24,248	5	0	5	117	24,555	5	0	5	119
				T3M	23,263	4	0	4	112	25,061	4	0	4	121	25,378	4	0	4	123
				T4M	22,824	5	0	5	110	24,588	5	0	5	119	24,899	5	0	5	120
				TFTM	23,414	5	0	5	113	25,223	5	0	5	122	25,543	5	0	5	123
				TSVS	23,579	5	0	1	114	25,401	5	0	1	123	25,722	5	0	1	124
				T5S	23,380	4	0	2	113	25,187	4	0	2	122	25,506	4	0	2	123
				T5M	23,374	5	0	3	113	25,181	5	0	3	122	25,499	5	0	3	123
				TSW	23,165	5	0	4	112	24,955	5	0	4	121	25,271	5	0	4	122
				BLC	19,231	4	0	4	93	20,717	4	0	4	100	20,979	4	0	4	101
				LCCO	13,734	2	0	3	66	14,796	2	0	4	71	14,983	2	0	4	72
				RCCO	13,716	4	0	4	66	14,776	4	0	4	71	14,963	4	0	4	72
60	1250	P13	231W	T1S	25,400	4	0	4	110	27,363	4	0	4	118	27,709	4	0	4	120
				T2S	25,254	5	0	5	109	27,205	5	0	5	118	27,550	5	0	5	119
				T2M	25,710	4	0	4	111	27,696	4	0	4	120	28,047	4	0	4	121
				T3S	24,862	5	0	5	108	26,783	5	0	5	116	27,122	5	0	5	117
				T3M	25,695	5	0	5	111	27,680	5	0	5	120	28,031	5	0	5	121
				T4M	25,210	5	0	5	109	27,158	5	0	5	118	27,502	5	0	5	119
				TFTM	25,861	5	0	5	112	27,860	5	0	5	121	28,212	5	0	5	122
				TSVS	26,043	5	0	1	113	28,056	5	0	1	121	28,411	5	0	1	123
				T5S	25,824	4	0	2	112	27,819	5	0	2	120	28,172	5	0	2	122
				T5M	25,818	5	0	3	112	27,813	5	0	3	120	28,165	5	0	3	122
				TSW	25,586	5	0	4	111	27,563	5	0	4	119	27,912	5	0	4	121
				BLC	21,241	4	0	4	92	22,882	4	0	4	99	23,172	4	0	4	100
				LCCO	15,170	2	0	4	66	16,342	2	0	4	71	16,549	2	0	4	72
				RCCO	15,150	5	0	5	66	16,321	5	0	5	71	16,527	5	0	5	72



## Capable Luminaire

This item is an A+ capable luminaire, which has been designed and tested to provide consistent color appearance and system-level interoperability.

- All configurations of this luminaire meet the Acuity Brands' specification for chromatic consistency
- This luminaire is A+ Certified when ordered with DTL® controls marked by a **shaded background**. DTL DLL equipped luminaires meet the A+ specification for luminaire to photocontrol interoperability<sup>1</sup>
- This luminaire is part of an A+ Certified solution for ROAM® or XPoint™ Wireless control networks, providing out-of-the-box control compatibility with simple commissioning, when ordered with drivers and control options marked by a **shaded background**<sup>1</sup>

To learn more about A+, visit [www.acuitybrands.com/aplus](http://www.acuitybrands.com/aplus).

1. See ordering tree for details.
2. A+ Certified Solutions for ROAM require the order of one ROAM node per luminaire. Sold Separately: [Link to Roam](#); [Link to DTL DLL](#)

## FEATURES & SPECIFICATIONS

### INTENDED USE

The sleek design of the D-Series Size 1 reflects the embedded high performance LED technology. It is ideal for many commercial and municipal applications, such as parking lots, plazas, campuses, and streetscapes.

### CONSTRUCTION

Single-piece die-cast aluminum housing has integral heat sink fins to optimize thermal management through conductive and convective cooling. Modular design allows for ease of maintenance and future light engine upgrades. The LED drivers are mounted in direct contact with the casting to promote low operating temperature and long life. Housing is completely sealed against moisture and environmental contaminants (IP65). Low EPA (1.01 ft<sup>2</sup>) for optimized pole wind loading.

### FINISH

Exterior parts are protected by a zinc-infused Super Durable TGIC thermoset powder coat finish that provides superior resistance to corrosion and weathering. A tightly controlled multi-stage process ensures a minimum 3 mils thickness for a finish that can withstand extreme climate changes without cracking or peeling. Available in both textured and non-textured finishes.

### OPTICS

Precision-molded proprietary acrylic lenses are engineered for superior area lighting distribution, uniformity, and pole spacing. Light engines are available in standard 3000 K, 4000 K and 5000 K (70 CRI) configurations. The D-Series Size 1 has zero uplight and qualifies as a Nighttime Friendly™ product, meaning it is consistent with the LEED® and Green Globes™ criteria for eliminating wasteful uplight.

### ELECTRICAL

Light engine configurations consist of high-efficacy LEDs mounted to metal-core circuit boards to maximize heat dissipation and promote long life (up to L85/100,000 hours at 25°C). Class 1 electronic drivers are designed to have a power factor >90%, THD <20%, and an expected life of 100,000 hours with <1% failure rate. Easily serviceable 10kV surge protection device meets a minimum Category C Low operation (per ANSI/IEEE C62.41.2).

### STANDARD CONTROLS

The DSX1 LED area luminaire has a number of control options. Dusk to dawn controls can be utilized via optional NEMA twist-lock photocell receptacles. Integrated motion sensors with on-board photocells feature field-adjustable programming and are suitable for mounting heights up to 30 feet.

### nLIGHT AIR CONTROLS

The DSX1 LED area luminaire is also available with nLight® AIR for the ultimate in wireless control. This powerful controls platform provides out-of-the-box basic motion sensing and photocontrol functionality and is suitable for mounting heights up to 40 feet. Once commissioned using a smartphone and the easy-to-use CLAIRITY app, nLight AIR equipped luminaires can be grouped, resulting in motion sensor and photocell group response without the need for additional equipment. Scheduled dimming with motion sensor over-ride can be achieved when used with the nLight Eclipse. Additional information about nLight Air can be found here.

### INSTALLATION

Included mounting block and integral arm facilitate quick and easy installation. Stainless steel bolts fasten the mounting block securely to poles and walls, enabling the D-Series Size 1 to withstand up to a 3.0 G vibration load rating per ANSI C136.31. The D-Series Size 1 utilizes the AERIS™ series pole drilling pattern (template #8). NEMA photocontrol receptacle are also available.

### LISTINGS

UL Listed for wet locations. Light engines are IP66 rated; luminaire is IP65 rated. Rated for -40°C minimum ambient. U.S. Patent No. D672,492 S. International patent pending.

DesignLights Consortium® (DLC) Premium qualified product and DLC qualified product.

Not all versions of this product may be DLC Premium qualified or DLC qualified. Please check the DLC Qualified Products List at [www.designlights.org/QPL](http://www.designlights.org/QPL) to confirm which versions are qualified.

International Dark-Sky Association (IDA) Fixture Seal of Approval (FSA) is available for all products on this page utilizing 3000K color temperature only.

### WARRANTY

5-year limited warranty. Complete warranty terms located at: [www.acuitybrands.com/CustomResources/Terms\\_and\\_conditions.aspx](http://www.acuitybrands.com/CustomResources/Terms_and_conditions.aspx)

**Note:** Actual performance may differ as a result of end-user environment and application.

All values are design or typical values, measured under laboratory conditions at 25 °C.

Specifications subject to change without notice.





# D-Series Size 1 LED Area Luminaire

d#series



Catalog Number
Notes
Type

Hit the Tab key or mouse over the page to see all interactive elements.

## Specifications

<b>EPA:</b>	1.01 ft <sup>2</sup> (0.09 m <sup>2</sup> )
<b>Length:</b>	33" (83.8 cm)
<b>Width:</b>	13" (33.0 cm)
<b>Height H1:</b>	7-1/2" (19.0 cm)
<b>Height H2:</b>	3-1/2"
<b>Weight (max):</b>	27 lbs (12.2 kg)

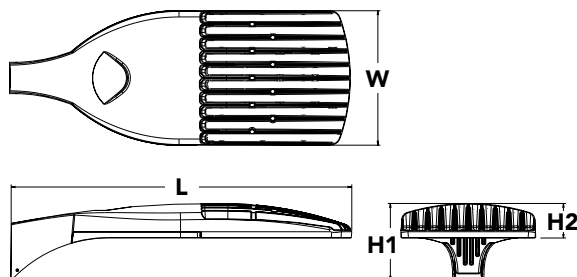

## Introduction

The modern styling of the D-Series is striking yet unobtrusive - making a bold, progressive statement even as it blends seamlessly with its environment. The D-Series distills the benefits of the latest in LED technology into a high performance, high efficacy, long-life luminaire.

The outstanding photometric performance results in sites with excellent uniformity, greater pole spacing and lower power density. It is ideal for replacing up to 750W metal halide in pedestrian and area lighting applications with typical energy savings of 65% and expected service life of over 100,000 hours.

A+ Capable options indicated by this color background.

## Ordering Information

EXAMPLE: DSX1 LED P7 40K T3M MVOLT SPA NLTAIR2 PIRHN DDBXD

DSX1 LED							
Series	LEDs	Color temperature		Distribution		Voltage	Mounting
<b>DSX1 LED</b>	<b>Forward optics</b> P1 P4 P7 P2 P5 P8 P3 P6 P9 <b>Rotated optics</b> P10 <sup>1</sup> P12 <sup>1</sup> P11 <sup>1</sup> P13 <sup>1</sup>	30K 40K 50K	3000 K 4000 K 5000 K	T1S Type I short T2S Type II short T2M Type II medium T3S Type III short T3M Type III medium T4M Type IV medium TFTM Forward throw medium	T5VS Type V very short T5S Type V short T5M Type V medium T5W Type V wide BLC Backlight control <sup>2</sup> LCCO Left corner cutoff <sup>2</sup> RCCO Right corner cutoff <sup>2</sup>	<b>MVOLT<sup>3</sup></b> 120 <sup>4</sup> 208 <sup>4</sup> 240 <sup>4</sup> 277 <sup>4</sup> 347 <sup>4,5</sup> 480 <sup>4,5</sup>	<b>Shipped included</b> SPA Square pole mounting RPA Round pole mounting WBA Wall bracket SPUMBA Square pole universal mounting adaptor <sup>6</sup> RPUMBA Round pole universal mounting adaptor <sup>6</sup> <b>Shipped separately</b> KMA8 DDBXD U Mast arm mounting bracket adaptor (specify finish) <sup>7</sup>

Control options	Other options	Finish (required)
<b>Shipped installed</b> NLTAIR2 nLight AIR generation 2 enabled <sup>8</sup> PIRHN Network, high/low motion/ambient sensor <sup>9</sup> PER NEMA twist-lock receptacle only (controls ordered separate) <sup>10</sup> PER5 Five-pin receptacle only (controls ordered separate) <sup>10,11</sup> PER7 Seven-pin receptacle only (controls ordered separate) <sup>10,11</sup> DMG 0-10v dimming wires pulled outside fixture (for use with an external control, ordered separately) <sup>12</sup> DS Dual switching <sup>12,13,14</sup>	PIR High/low, motion/ambient sensor, 8-15' mounting height, ambient sensor enabled at 5fc <sup>15,16</sup> PIRH High/low, motion/ambient sensor, 15-30' mounting height, ambient sensor enabled at 5fc <sup>15,16</sup> PIR1FC3V High/low, motion/ambient sensor, 8-15' mounting height, ambient sensor enabled at 1fc <sup>15,16</sup> PIRH1FC3V Bi-level, motion/ambient sensor, 15-30' mounting height, ambient sensor enabled at 1fc <sup>15,16</sup> FAO Field adjustable output <sup>14</sup>	<b>Shipped installed</b> HS House-side shield <sup>17</sup> SF Single fuse (120, 277, 347V) <sup>4</sup> DF Double fuse (208, 240, 480V) <sup>4</sup> L90 Left rotated optics <sup>1</sup> R90 Right rotated optics <sup>1</sup> <b>Shipped separately</b> BS Bird spikes <sup>18</sup> EGS External glare shield <sup>18</sup>
		DDBXD Dark bronze DBLXD Black DNAXD Natural aluminum DWHXD White DDBTXD Textured dark bronze DBLBXD Textured black DNATXD Textured natural aluminum DWHGXD Textured white



## Ordering Information

### Accessories

Ordered and shipped separately.

DLL127F 1.5 JU	Photocell - SSL twist-lock (120-277V) <sup>19</sup>
DLL347F 1.5 CUL JU	Photocell - SSL twist-lock (347V) <sup>19</sup>
DLL480F 1.5 CUL JU	Photocell - SSL twist-lock (480V) <sup>19</sup>
DSHORT SBK U	Shorting cap <sup>19</sup>
DSX1HS 30C U	House-side shield for P1, P2, P3, P4 and P5 <sup>17</sup>
DSX1HS 40C U	House-side shield for P6 and P7 <sup>17</sup>
DSX1HS 60C U	House-side shield for P8, P9, P10, P11 and P12 <sup>17</sup>
PUMBA DDBXD U*	Square and round pole universal mounting bracket (specify finish) <sup>20</sup>
KMA8 DDBXD U	Mast arm mounting bracket adaptor (specify finish) <sup>6</sup>

For more control options, visit [DTL](#) and [ROAM](#) online.

### NOTES

- P10, P11, P12 or P13 and rotated optics (L90, R90) only available together.
- Not available with HS.
- MVOLT driver operates on any line voltage from 120-277V (50/60 Hz).
- Single fuse (SF) requires 120V, 277V or 347V. Double fuse (DF) requires 208V, 240V or 480V.
- Not available in P1 or P10.
- Universal mounting brackets intended for retrofit on existing, pre-drilled poles only. 1.5 G vibration load rating per ANCI C136.31.
- Must order fixture with SPA option. Must be ordered as a separate accessory; see Accessories information. For use with 2-3/8" mast arm (not included).
- Must be ordered with PIRHN. Sensor cover available only in dark bronze, black, white and natural aluminum colors.
- Must be ordered with NLTAIR2. For more information on Light Air 2 visit [this link](#).
- Photocell ordered and shipped as a separate line item from Acuity Brands Controls. See accessories. Not available with DS option. Shorting cap included.
- If ROAM<sup>®</sup> node required, it must be ordered and shipped as a separate line item from Acuity Brands Controls. Node with integral dimming.
- Provides 50/50 fixture operation via (2) independent drivers. Not available with PER, PER5, PER7, PIR or PIRH. Not available P1, P2, P3, P4 or P5.
- Requires (2) separately switched circuits with isolated neutral. See Outdoor Control Technical Guide for details.
- Reference Motion Sensor table on page 4.
- Reference controls options table on page 4 to see functionality.
- Not available with other dimming controls options
- Not available with BLC, LCCO and RCCO distribution. Also available as a separate accessory; see Accessories information.
- Must be ordered with fixture for factory pre-drilling.
- Requires luminaire to be specified with PER, PER5 or PER7 option. See PER Table on page 3.
- For retrofit use only.

## Options

### EGS - External Glare Shield

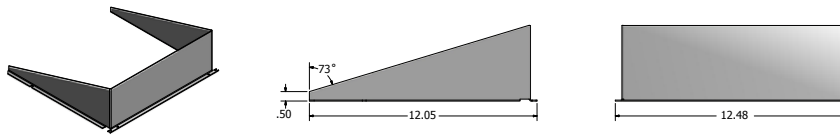

## Drilling

### HANDHOLE ORIENTATION

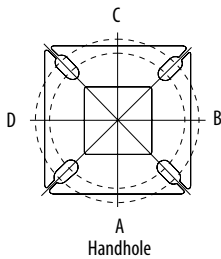

### Tenon Mounting Slipfitter\*\*

Tenon O.D.	Mounting	Single Unit	2 @ 180	2 @ 90	3 @ 120	3 @ 90	4 @ 90
2-3/8"	SPA/RPA	AS3-5 190	AS3-5 280	AS3-5 290	AS3-5 320	AS3-5 390	AS3-5 490
	SPUMBA	AS3-5 190	AS3-5 280	AS4-5 290	AS3-5 320	AS4-5 390	AS4-5 490
	RUPUMBA	AS3-5 190	AS3-5 280		AS3-5 320		
2-7/8"	SPA/RPA	AST25-190	AST25-280	AST25-290	AST25-320	AST25-390	AST25-490
	SPUMBA	AST25-190	AST25-280		AST25-320		
	RUPUMBA	AST25-190	AST25-280		AST25-320		
4"	SPA/RPA	AST35-190	AST35-280	AST35-290	AST35-320	AST35-390	AST35-490
	SPUMBA	AST35-190	AST35-280	AST35-290	AST35-320	AST35-390	AST35-490
	RUPUMBA	AST35-190	AST35-280		AST35-320		

Template #8

Top of Pole

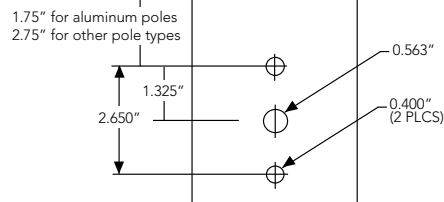

Mounting Option	Drilling Template	Single	2 @ 180	2 @ 90	3 @ 90	3 @ 120	4 @ 90
Head Location		Side B	Side B & D	Side B & C	Side B, C & D	Round Pole Only	Side A, B, C & D
Drill Nomenclature	#8	DM19AS	DM28AS	DM29AS	DM39AS	DM32AS	DM49AS

	Drilling Template	Minimum Acceptable Outside Pole Dimension					
SPA	#8	2-7/8"	2-7/8"	3.5"	3.5"	3"	3.5"
RPA	#8	2-7/8"	2-7/8"	3.5"	3.5"	3"	3.5"
SPUMBA	#5	2-7/8"	3"	4"	4"	3.5"	4"
RPUMBA	#5	2-7/8"	3.5"	5"	5"	3.5"	5"

# Photometric Diagrams

To see complete photometric reports or download .ies files for this product, visit Lithonia Lighting's [D-Series Area Size 1 homepage](#).

Isofootcandle plots for the DSX1 LED 60C 1000 40K. Distances are in units of mounting height (25').

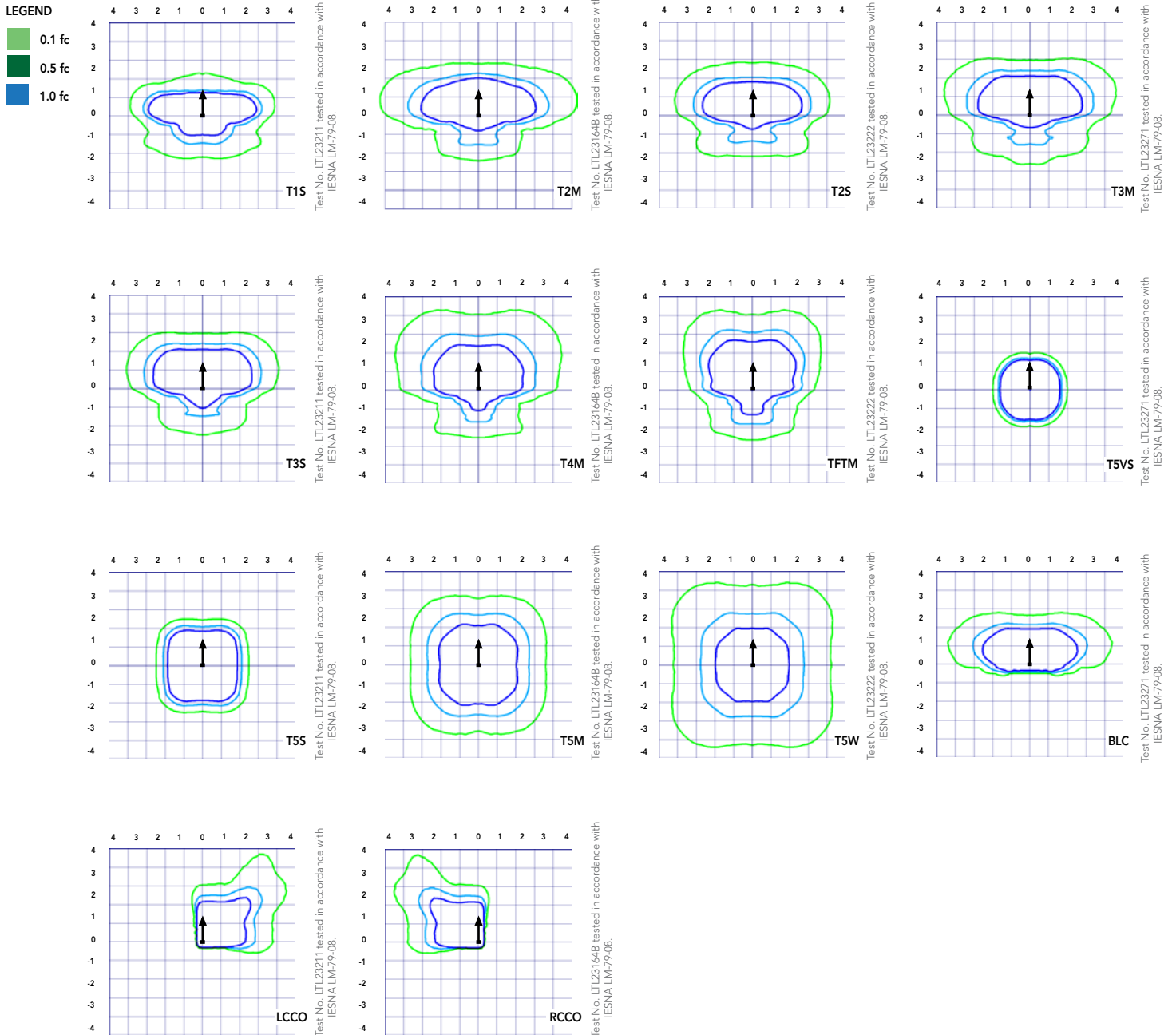

## Performance Data

### Lumen Ambient Temperature (LAT) Multipliers

Use these factors to determine relative lumen output for average ambient temperatures from 0-40°C (32-104°F).

Ambient		Lumen Multiplier
0°C	32°F	1.04
5°C	41°F	1.04
10°C	50°F	1.03
15°C	59°F	1.02
20°C	68°F	1.01
<b>25°C</b>	<b>77°F</b>	<b>1.00</b>
30°C	86°F	0.99
35°C	95°F	0.98
40°C	104°F	0.97

### Projected LED Lumen Maintenance

Data references the extrapolated performance projections for the platforms noted in a **25°C ambient**, based on 10,000 hours of LED testing (tested per IESNA LM-80-08 and projected per IESNA TM-21-11).

To calculate LLF, use the lumen maintenance factor that corresponds to the desired number of operating hours below. For other lumen maintenance values, contact factory.

Operating Hours	Lumen Maintenance Factor
0	1.00
25,000	0.96
50,000	0.92
100,000	0.85

#### Motion Sensor Default Settings

Option	Dimmed State	High Level (when triggered)	Photocell Operation	Dwell Time	Ramp-up Time	Ramp-down Time
PIR or PIRH	3V (37%) Output	10V (100%) Output	Enabled @ 5FC	5 min	3 sec	5 min
*PIR1FC3V or PIRH1FC3V	3V (37%) Output	10V (100%) Output	Enabled @ 1FC	5 min	3 sec	5 min

\*for use when motion sensor is used as dusk to dawn control.

### Electrical Load

	Performance Package	LED Count	Drive Current	Wattage	Current (A)					
					120	208	240	277	347	480
Forward Optics (Non-Rotated)	P1	30	530	54	0.45	0.26	0.23	0.19	0.10	0.12
	P2	30	700	70	0.59	0.34	0.30	0.25	0.20	0.16
	P3	30	1050	102	0.86	0.50	0.44	0.38	0.30	0.22
	P4	30	1250	125	1.06	0.60	0.52	0.46	0.37	0.27
	P5	30	1400	138	1.16	0.67	0.58	0.51	0.40	0.29
	P6	40	1250	163	1.36	0.78	0.68	0.59	0.47	0.34
	P7	40	1400	183	1.53	0.88	0.76	0.66	0.53	0.38
	P8	60	1050	207	1.74	0.98	0.87	0.76	0.64	0.49
	P9	60	1250	241	2.01	1.16	1.01	0.89	0.70	0.51
Rotated Optics (Requires L90 or R90)	P10	60	530	106	0.90	0.52	0.47	0.43	0.33	0.27
	P11	60	700	137	1.15	0.67	0.60	0.53	0.42	0.32
	P12	60	1050	207	1.74	0.99	0.87	0.76	0.60	0.46
	P13	60	1250	231	1.93	1.12	0.97	0.86	0.67	0.49

#### Controls Options

Nomenclature	Description	Functionality	Primary control device	Notes
FA0	Field adjustable output device installed inside the luminaire; wired to the driver dimming leads.	Allows the luminaire to be manually dimmed, effectively trimming the light output.	FA0 device	Cannot be used with other controls options that need the 0-10V leads
DS	Drivers wired independently for 50/50 luminaire operation	The luminaire is wired to two separate circuits, allowing for 50/50 operation.	Independently wired drivers	Requires two separately switched circuits. Consider nLight AIR as a more cost effective alternative.
PERS or PER7	Twist-lock photocell receptacle	Compatible with standard twist-lock photocells for dusk to dawn operation, or advanced control nodes that provide 0-10V dimming signals.	Twist-lock photocells such as DLL Elite or advanced control nodes such as ROAM.	Pins 4 & 5 to dimming leads on driver, Pins 6 & 7 are capped inside luminaire
PIR or PIRH	Motion sensors with integral photocell. PIR for 8-15' mounting; PIRH for 15-30' mounting	Luminaires dim when no occupancy is detected.	Acuity Controls SBOR	Also available with PIRH1FC3V when the sensor photocell is used for dusk-to-dawn operation.
NLTAIR2 PIRHN	nLight AIR enabled luminaire for motion sensing, photocell and wireless communication.	Motion and ambient light sensing with group response. Scheduled dimming with motion sensor over-ride when wirelessly connected to the nLight Eclipse.	nLight Air rSDGR	nLight AIR sensors can be programmed and commissioned from the ground using the CIAIRity Pro app.

# Performance Data

## Lumen Output

Lumen values are from photometric tests performed in accordance with IESNA LM-79-08. Data is considered to be representative of the configurations shown, within the tolerances allowed by Lighting Facts Contact factory for performance data on any configurations not shown here.

Forward Optics																			
LED Count	Drive Current	Power Package	System Watts	Dist. Type	30K (3000 K, 70 CRI)					40K (4000 K, 70 CRI)					50K (5000 K, 70 CRI)				
					Lumens	B	U	G	LPW	Lumens	B	U	G	LPW	Lumens	B	U	G	LPW
30	530	P1	54W	T1S	6,457	2	0	2	120	6,956	2	0	2	129	7,044	2	0	2	130
				T2S	6,450	2	0	2	119	6,949	2	0	2	129	7,037	2	0	2	130
				T2M	6,483	1	0	1	120	6,984	2	0	2	129	7,073	2	0	2	131
				T3S	6,279	2	0	2	116	6,764	2	0	2	125	6,850	2	0	2	127
				T3M	6,468	1	0	2	120	6,967	1	0	2	129	7,056	1	0	2	131
				T4M	6,327	1	0	2	117	6,816	1	0	2	126	6,902	1	0	2	128
				TFTM	6,464	1	0	2	120	6,963	1	0	2	129	7,051	1	0	2	131
				TSVS	6,722	2	0	0	124	7,242	3	0	0	134	7,334	3	0	0	136
				T5S	6,728	2	0	1	125	7,248	2	0	1	134	7,340	2	0	1	136
				T5M	6,711	3	0	1	124	7,229	3	0	1	134	7,321	3	0	2	136
				TSW	6,667	3	0	2	123	7,182	3	0	2	133	7,273	3	0	2	135
				BLC	5,299	1	0	1	98	5,709	1	0	2	106	5,781	1	0	2	107
				LCCO	3,943	1	0	2	73	4,248	1	0	2	79	4,302	1	0	2	80
				RCCO	3,943	1	0	2	73	4,248	1	0	2	79	4,302	1	0	2	80
30	700	P2	70W	T1S	8,249	2	0	2	118	8,886	2	0	2	127	8,999	2	0	2	129
				T2S	8,240	2	0	2	118	8,877	2	0	2	127	8,989	2	0	2	128
				T2M	8,283	2	0	2	118	8,923	2	0	2	127	9,036	2	0	2	129
				T3S	8,021	2	0	2	115	8,641	2	0	2	123	8,751	2	0	2	125
				T3M	8,263	2	0	2	118	8,901	2	0	2	127	9,014	2	0	2	129
				T4M	8,083	2	0	2	115	8,708	2	0	2	124	8,818	2	0	2	126
				TFTM	8,257	2	0	2	118	8,896	2	0	2	127	9,008	2	0	2	129
				TSVS	8,588	3	0	0	123	9,252	3	0	0	132	9,369	3	0	0	134
				T5S	8,595	3	0	1	123	9,259	3	0	1	132	9,376	3	0	1	134
				T5M	8,573	3	0	2	122	9,236	3	0	2	132	9,353	3	0	2	134
				TSW	8,517	3	0	2	122	9,175	4	0	2	131	9,291	4	0	2	133
				BLC	6,770	1	0	2	97	7,293	1	0	2	104	7,386	1	0	2	106
				LCCO	5,038	1	0	2	72	5,427	1	0	2	78	5,496	1	0	2	79
				RCCO	5,038	1	0	2	72	5,427	1	0	2	78	5,496	1	0	2	79
30	1050	P3	102W	T1S	11,661	2	0	2	114	12,562	3	0	3	123	12,721	3	0	3	125
				T2S	11,648	2	0	2	114	12,548	3	0	3	123	12,707	3	0	3	125
				T2M	11,708	2	0	2	115	12,613	2	0	2	124	12,773	2	0	2	125
				T3S	11,339	2	0	2	111	12,215	3	0	3	120	12,370	3	0	3	121
				T3M	11,680	2	0	2	115	12,582	2	0	2	123	12,742	2	0	2	125
				T4M	11,426	2	0	3	112	12,309	2	0	3	121	12,465	2	0	3	122
				TFTM	11,673	2	0	2	114	12,575	2	0	3	123	12,734	2	0	3	125
				TSVS	12,140	3	0	1	119	13,078	3	0	1	128	13,244	3	0	1	130
				T5S	12,150	3	0	1	119	13,089	3	0	1	128	13,254	3	0	1	130
				T5M	12,119	4	0	2	119	13,056	4	0	2	128	13,221	4	0	2	130
				TSW	12,040	4	0	3	118	12,970	4	0	3	127	13,134	4	0	3	129
				BLC	9,570	1	0	2	94	10,310	1	0	2	101	10,440	1	0	2	102
				LCCO	7,121	1	0	3	70	7,671	1	0	3	75	7,768	1	0	3	76
				RCCO	7,121	1	0	3	70	7,671	1	0	3	75	7,768	1	0	3	76
30	1250	P4	125W	T1S	13,435	3	0	3	107	14,473	3	0	3	116	14,657	3	0	3	117
				T2S	13,421	3	0	3	107	14,458	3	0	3	116	14,641	3	0	3	117
				T2M	13,490	2	0	2	108	14,532	3	0	3	116	14,716	3	0	3	118
				T3S	13,064	3	0	3	105	14,074	3	0	3	113	14,252	3	0	3	114
				T3M	13,457	2	0	2	108	14,497	2	0	2	116	14,681	2	0	2	117
				T4M	13,165	2	0	3	105	14,182	2	0	3	113	14,362	2	0	3	115
				TFTM	13,449	2	0	3	108	14,488	2	0	3	116	14,672	2	0	3	117
				TSVS	13,987	4	0	1	112	15,068	4	0	1	121	15,259	4	0	1	122
				T5S	13,999	3	0	1	112	15,080	3	0	1	121	15,271	3	0	1	122
				T5M	13,963	4	0	2	112	15,042	4	0	2	120	15,233	4	0	2	122
				TSW	13,872	4	0	3	111	14,944	4	0	3	120	15,133	4	0	3	121
				BLC	11,027	1	0	2	88	11,879	1	0	2	95	12,029	1	0	2	96
				LCCO	8,205	1	0	3	66	8,839	1	0	3	71	8,951	1	0	3	72
				RCCO	8,205	1	0	3	66	8,839	1	0	3	71	8,951	1	0	3	72
30	1400	P5	138W	T1S	14,679	3	0	3	106	15,814	3	0	3	115	16,014	3	0	3	116
				T2S	14,664	3	0	3	106	15,797	3	0	3	114	15,997	3	0	3	116
				T2M	14,739	3	0	3	107	15,878	3	0	3	115	16,079	3	0	3	117
				T3S	14,274	3	0	3	103	15,377	3	0	3	111	15,572	3	0	3	113
				T3M	14,704	2	0	3	107	15,840	3	0	3	115	16,040	3	0	3	116
				T4M	14,384	2	0	3	104	15,496	3	0	3	112	15,692	3	0	3	114
				TFTM	14,695	2	0	3	106	15,830	3	0	3	115	16,030	3	0	3	116
				TSVS	15,283	4	0	1	111	16,464	4	0	1	119	16,672	4	0	1	121
				T5S	15,295	3	0	1	111	16,477	4	0	1	119	16,686	4	0	1	121
				T5M	15,257	4	0	2	111	16,435	4	0	2	119	16,644	4	0	2	121
				TSW	15,157	4	0	3	110	16,328	4	0	3	118	16,534	4	0	3	120
				BLC	12,048	1	0	2	87	12,979	1	0	2	94	13,143	1	0	2	95
				LCCO	8,965	1	0	3	65	9,657	1	0	3	70	9,780	1	0	3	71
				RCCO	8,965	1	0	3	65	9,657	1	0	3	70	9,780	1	0	3	71



# Performance Data

## Lumen Output

Lumen values are from photometric tests performed in accordance with IESNA LM-79-08. Data is considered to be representative of the configurations shown, within the tolerances allowed by Lighting Facts. Contact factory for performance data on any configurations not shown here.

Forward Optics																			
LED Count	Drive Current	Power Package	System Watts	Dist. Type	30K (3000 K, 70 CRI)					40K (4000 K, 70 CRI)					50K (5000 K, 70 CRI)				
					Lumens	B	U	G	LPW	Lumens	B	U	G	LPW	Lumens	B	U	G	LPW
40	1250	P6	163W	T1S	17,654	3	0	3	108	19,018	3	0	3	117	19,259	3	0	3	118
				T2S	17,635	3	0	3	108	18,998	3	0	3	117	19,238	3	0	3	118
				T2M	17,726	3	0	3	109	19,096	3	0	3	117	19,337	3	0	3	119
				T3S	17,167	3	0	3	105	18,493	3	0	3	113	18,727	3	0	3	115
				T3M	17,683	3	0	3	108	19,049	3	0	3	117	19,290	3	0	3	118
				T4M	17,299	3	0	3	106	18,635	3	0	4	114	18,871	3	0	4	116
				TFTM	17,672	3	0	3	108	19,038	3	0	4	117	19,279	3	0	4	118
				TSVS	18,379	4	0	1	113	19,800	4	0	1	121	20,050	4	0	1	123
				T5S	18,394	4	0	2	113	19,816	4	0	2	122	20,066	4	0	2	123
				T5M	18,348	4	0	2	113	19,766	4	0	2	121	20,016	4	0	2	123
				TSW	18,228	5	0	3	112	19,636	5	0	3	120	19,885	5	0	3	122
				BLC	14,489	2	0	2	89	15,609	2	0	3	96	15,806	2	0	3	97
				LCCO	10,781	1	0	3	66	11,614	1	0	3	71	11,761	2	0	3	72
				RCCO	10,781	1	0	3	66	11,614	1	0	3	71	11,761	2	0	3	72
40	1400	P7	183W	T1S	19,227	3	0	3	105	20,712	3	0	3	113	20,975	3	0	3	115
				T2S	19,206	3	0	3	105	20,690	3	0	3	113	20,952	3	0	3	114
				T2M	19,305	3	0	3	105	20,797	3	0	3	114	21,060	3	0	3	115
				T3S	18,696	3	0	3	102	20,141	3	0	3	110	20,396	3	0	4	111
				T3M	19,258	3	0	3	105	20,746	3	0	3	113	21,009	3	0	3	115
				T4M	18,840	3	0	4	103	20,296	3	0	4	111	20,553	3	0	4	112
				TFTM	19,246	3	0	4	105	20,734	3	0	4	113	20,996	3	0	4	115
				TSVS	20,017	4	0	1	109	21,564	4	0	1	118	21,837	4	0	1	119
				T5S	20,033	4	0	2	109	21,581	4	0	2	118	21,854	4	0	2	119
				T5M	19,983	4	0	2	109	21,527	5	0	3	118	21,799	5	0	3	119
				TSW	19,852	5	0	3	108	21,386	5	0	3	117	21,656	5	0	3	118
				BLC	15,780	2	0	3	86	16,999	2	0	3	93	17,214	2	0	3	94
				LCCO	11,742	2	0	3	64	12,649	2	0	3	69	12,809	2	0	3	70
				RCCO	11,742	2	0	3	64	12,649	2	0	3	69	12,809	2	0	3	70
60	1050	P8	207W	T1S	22,490	3	0	3	109	24,228	3	0	3	117	24,535	3	0	3	119
				T2S	22,466	3	0	4	109	24,202	3	0	4	117	24,509	3	0	4	118
				T2M	22,582	3	0	3	109	24,327	3	0	3	118	24,635	3	0	3	119
				T3S	21,870	3	0	4	106	23,560	3	0	4	114	23,858	3	0	4	115
				T3M	22,527	3	0	4	109	24,268	3	0	4	117	24,575	3	0	4	119
				T4M	22,038	3	0	4	106	23,741	3	0	4	115	24,041	3	0	4	116
				TFTM	22,513	3	0	4	109	24,253	3	0	4	117	24,560	3	0	4	119
				TSVS	23,415	5	0	1	113	25,224	5	0	1	122	25,543	5	0	1	123
				T5S	23,434	4	0	2	113	25,244	4	0	2	122	25,564	4	0	2	123
				T5M	23,374	5	0	3	113	25,181	5	0	3	122	25,499	5	0	3	123
				TSW	23,221	5	0	4	112	25,016	5	0	4	121	25,332	5	0	4	122
				BLC	18,458	2	0	3	89	19,885	2	0	3	96	20,136	2	0	3	97
				LCCO	13,735	2	0	3	66	14,796	2	0	4	71	14,983	2	0	4	72
				RCCO	13,735	2	0	3	66	14,796	2	0	4	71	14,983	2	0	4	72
60	1250	P9	241W	T1S	25,575	3	0	3	106	27,551	3	0	3	114	27,900	3	0	3	116
				T2S	25,548	3	0	4	106	27,522	3	0	4	114	27,871	3	0	4	116
				T2M	25,680	3	0	3	107	27,664	3	0	3	115	28,014	3	0	3	116
				T3S	24,870	3	0	4	103	26,791	3	0	4	111	27,130	3	0	4	113
				T3M	25,617	3	0	4	106	27,597	3	0	4	115	27,946	3	0	4	116
				T4M	25,061	3	0	4	104	26,997	3	0	4	112	27,339	3	0	4	113
				TFTM	25,602	3	0	4	106	27,580	3	0	4	114	27,929	3	0	4	116
				TSVS	26,626	5	0	1	110	28,684	5	0	1	119	29,047	5	0	1	121
				T5S	26,648	4	0	2	111	28,707	5	0	2	119	29,070	5	0	2	121
				T5M	26,581	5	0	3	110	28,635	5	0	3	119	28,997	5	0	3	120
				TSW	26,406	5	0	4	110	28,447	5	0	4	118	28,807	5	0	4	120
				BLC	20,990	2	0	3	87	22,612	2	0	3	94	22,898	2	0	3	95
				LCCO	15,619	2	0	4	65	16,825	2	0	4	70	17,038	2	0	4	71
				RCCO	15,619	2	0	4	65	16,825	2	0	4	70	17,038	2	0	4	71



# Performance Data

## Lumen Output

Lumen values are from photometric tests performed in accordance with IESNA LM-79-08. Data is considered to be representative of the configurations shown, within the tolerances allowed by Lighting Facts. Contact factory for performance data on any configurations not shown here.

Rotated Optics																			
LED Count	Drive Current	Power Package	System Watts	Dist. Type	30K (3000 K, 70 CRI)					40K (4000 K, 70 CRI)					50K (5000 K, 70 CRI)				
					Lumens	B	U	G	LPW	Lumens	B	U	G	LPW	Lumens	B	U	G	LPW
60	530	P10	106W	T1S	13,042	3	0	3	123	14,050	3	0	3	133	14,228	3	0	3	134
				T2S	12,967	4	0	4	122	13,969	4	0	4	132	14,146	4	0	4	133
				T2M	13,201	3	0	3	125	14,221	3	0	3	134	14,401	3	0	3	136
				T3S	12,766	4	0	4	120	13,752	4	0	4	130	13,926	4	0	4	131
				T3M	13,193	4	0	4	124	14,213	4	0	4	134	14,393	4	0	4	136
				T4M	12,944	4	0	4	122	13,945	4	0	4	132	14,121	4	0	4	133
				TFTM	13,279	4	0	4	125	14,305	4	0	4	135	14,486	4	0	4	137
				TSVS	13,372	3	0	1	126	14,405	4	0	1	136	14,588	4	0	1	138
				T5S	13,260	3	0	1	125	14,284	3	0	1	135	14,465	3	0	1	136
				T5M	13,256	4	0	2	125	14,281	4	0	2	135	14,462	4	0	2	136
				TSW	13,137	4	0	3	124	14,153	4	0	3	134	14,332	4	0	3	135
				BLC	10,906	3	0	3	103	11,749	3	0	3	111	11,898	3	0	3	112
				LCCO	7,789	1	0	3	73	8,391	1	0	3	79	8,497	1	0	3	80
				RCCO	7,779	4	0	4	73	8,380	4	0	4	79	8,486	4	0	4	80
60	700	P11	137W	T1S	16,556	3	0	3	121	17,835	3	0	3	130	18,061	4	0	4	132
				T2S	16,461	4	0	4	120	17,733	4	0	4	129	17,957	4	0	4	131
				T2M	16,758	4	0	4	122	18,053	4	0	4	132	18,281	4	0	4	133
				T3S	16,205	4	0	4	118	17,457	4	0	4	127	17,678	4	0	4	129
				T3M	16,748	4	0	4	122	18,042	4	0	4	132	18,271	4	0	4	133
				T4M	16,432	4	0	4	120	17,702	4	0	4	129	17,926	4	0	4	131
				TFTM	16,857	4	0	4	123	18,159	4	0	4	133	18,389	4	0	4	134
				TSVS	16,975	4	0	1	124	18,287	4	0	1	133	18,518	4	0	1	135
				T5S	16,832	4	0	1	123	18,133	4	0	2	132	18,362	4	0	2	134
				T5M	16,828	4	0	2	123	18,128	4	0	2	132	18,358	4	0	2	134
				TSW	16,677	4	0	3	122	17,966	5	0	3	131	18,193	5	0	3	133
				BLC	13,845	3	0	3	101	14,915	3	0	3	109	15,103	3	0	3	110
				LCCO	9,888	1	0	3	72	10,652	2	0	3	78	10,787	2	0	3	79
				RCCO	9,875	4	0	4	72	10,638	4	0	4	78	10,773	4	0	4	79
60	1050	P12	207W	T1S	22,996	4	0	4	111	24,773	4	0	4	120	25,087	4	0	4	121
				T2S	22,864	4	0	4	110	24,631	5	0	5	119	24,943	5	0	5	120
				T2M	23,277	4	0	4	112	25,075	4	0	4	121	25,393	4	0	4	123
				T3S	22,509	4	0	4	109	24,248	5	0	5	117	24,555	5	0	5	119
				T3M	23,263	4	0	4	112	25,061	4	0	4	121	25,378	4	0	4	123
				T4M	22,824	5	0	5	110	24,588	5	0	5	119	24,899	5	0	5	120
				TFTM	23,414	5	0	5	113	25,223	5	0	5	122	25,543	5	0	5	123
				TSVS	23,579	5	0	1	114	25,401	5	0	1	123	25,722	5	0	1	124
				T5S	23,380	4	0	2	113	25,187	4	0	2	122	25,506	4	0	2	123
				T5M	23,374	5	0	3	113	25,181	5	0	3	122	25,499	5	0	3	123
				TSW	23,165	5	0	4	112	24,955	5	0	4	121	25,271	5	0	4	122
				BLC	19,231	4	0	4	93	20,717	4	0	4	100	20,979	4	0	4	101
				LCCO	13,734	2	0	3	66	14,796	2	0	4	71	14,983	2	0	4	72
				RCCO	13,716	4	0	4	66	14,776	4	0	4	71	14,963	4	0	4	72
60	1250	P13	231W	T1S	25,400	4	0	4	110	27,363	4	0	4	118	27,709	4	0	4	120
				T2S	25,254	5	0	5	109	27,205	5	0	5	118	27,550	5	0	5	119
				T2M	25,710	4	0	4	111	27,696	4	0	4	120	28,047	4	0	4	121
				T3S	24,862	5	0	5	108	26,783	5	0	5	116	27,122	5	0	5	117
				T3M	25,695	5	0	5	111	27,680	5	0	5	120	28,031	5	0	5	121
				T4M	25,210	5	0	5	109	27,158	5	0	5	118	27,502	5	0	5	119
				TFTM	25,861	5	0	5	112	27,860	5	0	5	121	28,212	5	0	5	122
				TSVS	26,043	5	0	1	113	28,056	5	0	1	121	28,411	5	0	1	123
				T5S	25,824	4	0	2	112	27,819	5	0	2	120	28,172	5	0	2	122
				T5M	25,818	5	0	3	112	27,813	5	0	3	120	28,165	5	0	3	122
				TSW	25,586	5	0	4	111	27,563	5	0	4	119	27,912	5	0	4	121
				BLC	21,241	4	0	4	92	22,882	4	0	4	99	23,172	4	0	4	100
				LCCO	15,170	2	0	4	66	16,342	2	0	4	71	16,549	2	0	4	72
				RCCO	15,150	5	0	5	66	16,321	5	0	5	71	16,527	5	0	5	72

## Capable Luminaire

This item is an A+ capable luminaire, which has been designed and tested to provide consistent color appearance and system-level interoperability.

- All configurations of this luminaire meet the Acuity Brands' specification for chromatic consistency
- This luminaire is A+ Certified when ordered with DTL® controls marked by a shaded background. DTL DLL equipped luminaires meet the A+ specification for luminaire to photocontrol interoperability<sup>1</sup>
- This luminaire is part of an A+ Certified solution for ROAM® or XPoint™ Wireless control networks, providing out-of-the-box control compatibility with simple commissioning, when ordered with drivers and control options marked by a shaded background<sup>1</sup>

To learn more about A+, visit [www.acuitybrands.com/aplus](http://www.acuitybrands.com/aplus).

1. See ordering tree for details.
2. A+ Certified Solutions for ROAM require the order of one ROAM node per luminaire. Sold Separately: [Link to Roam](#); [Link to DTL DLL](#)

## FEATURES & SPECIFICATIONS

### INTENDED USE

The sleek design of the D-Series Size 1 reflects the embedded high performance LED technology. It is ideal for many commercial and municipal applications, such as parking lots, plazas, campuses, and streetscapes.

### CONSTRUCTION

Single-piece die-cast aluminum housing has integral heat sink fins to optimize thermal management through conductive and convective cooling. Modular design allows for ease of maintenance and future light engine upgrades. The LED drivers are mounted in direct contact with the casting to promote low operating temperature and long life. Housing is completely sealed against moisture and environmental contaminants (IP65). Low EPA (1.01 ft<sup>2</sup>) for optimized pole wind loading.

### FINISH

Exterior parts are protected by a zinc-infused Super Durable TGIC thermoset powder coat finish that provides superior resistance to corrosion and weathering. A tightly controlled multi-stage process ensures a minimum 3 mils thickness for a finish that can withstand extreme climate changes without cracking or peeling. Available in both textured and non-textured finishes.

### OPTICS

Precision-molded proprietary acrylic lenses are engineered for superior area lighting distribution, uniformity, and pole spacing. Light engines are available in standard 3000 K, 4000 K and 5000 K (70 CRI) configurations. The D-Series Size 1 has zero uplight and qualifies as a Nighttime Friendly™ product, meaning it is consistent with the LEED® and Green Globes™ criteria for eliminating wasteful uplight.

### ELECTRICAL

Light engine configurations consist of high-efficacy LEDs mounted to metal-core circuit boards to maximize heat dissipation and promote long life (up to L85/100,000 hours at 25°C). Class 1 electronic drivers are designed to have a power factor >90%, THD <20%, and an expected life of 100,000 hours with <1% failure rate. Easily serviceable 10kV surge protection device meets a minimum Category C Low operation (per ANSI/IEEE C62.41.2).

### STANDARD CONTROLS

The DSX1 LED area luminaire has a number of control options. Dusk to dawn controls can be utilized via optional NEMA twist-lock photocell receptacles. Integrated motion sensors with on-board photocells feature field-adjustable programming and are suitable for mounting heights up to 30 feet.

### nLIGHT AIR CONTROLS

The DSX1 LED area luminaire is also available with nLight® AIR for the ultimate in wireless control. This powerful controls platform provides out-of-the-box basic motion sensing and photocontrol functionality and is suitable for mounting heights up to 40 feet. Once commissioned using a smartphone and the easy-to-use CLAIRITY app, nLight AIR equipped luminaires can be grouped, resulting in motion sensor and photocell group response without the need for additional equipment. Scheduled dimming with motion sensor over-ride can be achieved when used with the nLight Eclipse. Additional information about nLight Air can be found here.

### INSTALLATION

Included mounting block and integral arm facilitate quick and easy installation. Stainless steel bolts fasten the mounting block securely to poles and walls, enabling the D-Series Size 1 to withstand up to a 3.0 G vibration load rating per ANSI C136.31. The D-Series Size 1 utilizes the AERIS™ series pole drilling pattern (template #8). NEMA photocontrol receptacle are also available.

### LISTINGS

UL Listed for wet locations. Light engines are IP66 rated; luminaire is IP65 rated. Rated for -40°C minimum ambient. U.S. Patent No. D672,492 S. International patent pending.

DesignLights Consortium® (DLC) Premium qualified product and DLC qualified product.

Not all versions of this product may be DLC Premium qualified or DLC qualified. Please check the DLC Qualified Products List at [www.designlights.org/QPL](http://www.designlights.org/QPL) to confirm which versions are qualified.

International Dark-Sky Association (IDA) Fixture Seal of Approval (FSA) is available for all products on this page utilizing 3000K color temperature only.

### WARRANTY

5-year limited warranty. Complete warranty terms located at: [www.acuitybrands.com/CustomResources/Terms\\_and\\_conditions.aspx](http://www.acuitybrands.com/CustomResources/Terms_and_conditions.aspx)

**Note:** Actual performance may differ as a result of end-user environment and application.

All values are design or typical values, measured under laboratory conditions at 25 °C.

Specifications subject to change without notice.

