

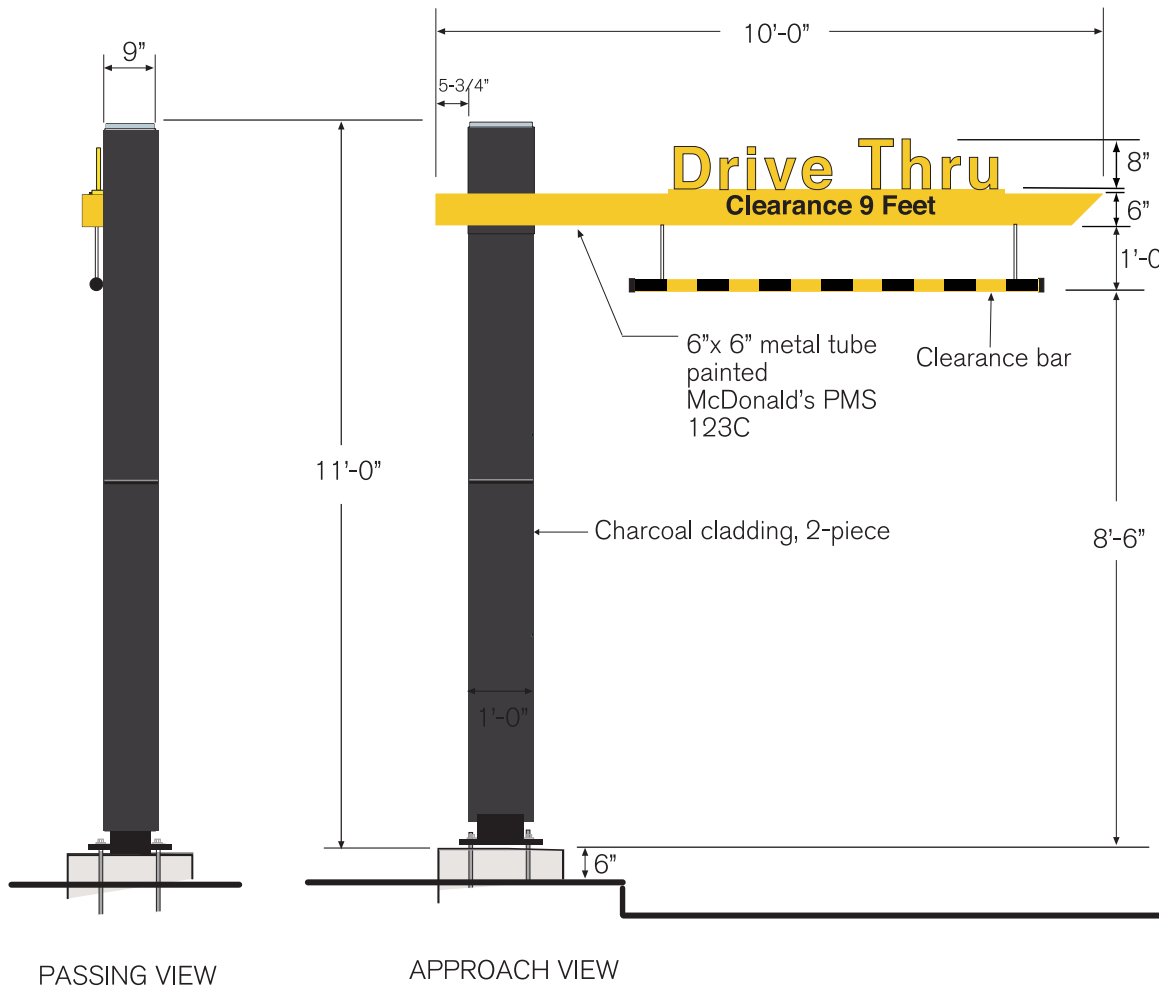

Welcome Point Gateway - Charcoal 2PC



Illumination: N/A

Ship Weight: 790 lbs.

- Other:**
- Non-illuminated clearance sign with spring loaded break away clearance arm.
 - Adjustable bang bar.

Slim Springboard Canopy w/Audio Only - Yellow

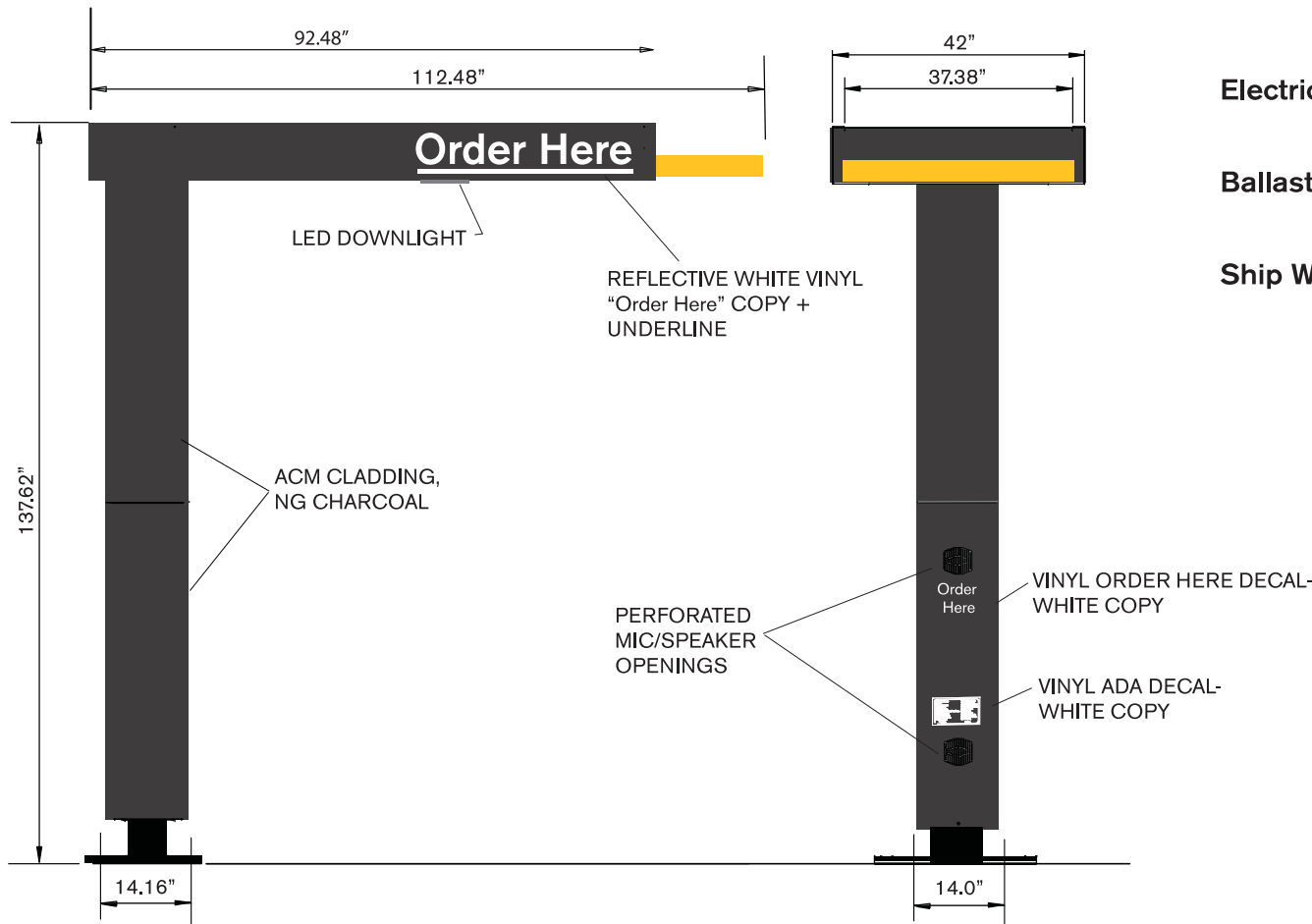

Illumination: LED Downlighting

Electrical: 1.5 Amps 120 volt, 60 Hz

Ballast:

Ship Weight:

G10 – Single Unit



Main display area

Depth

Total height including base structure

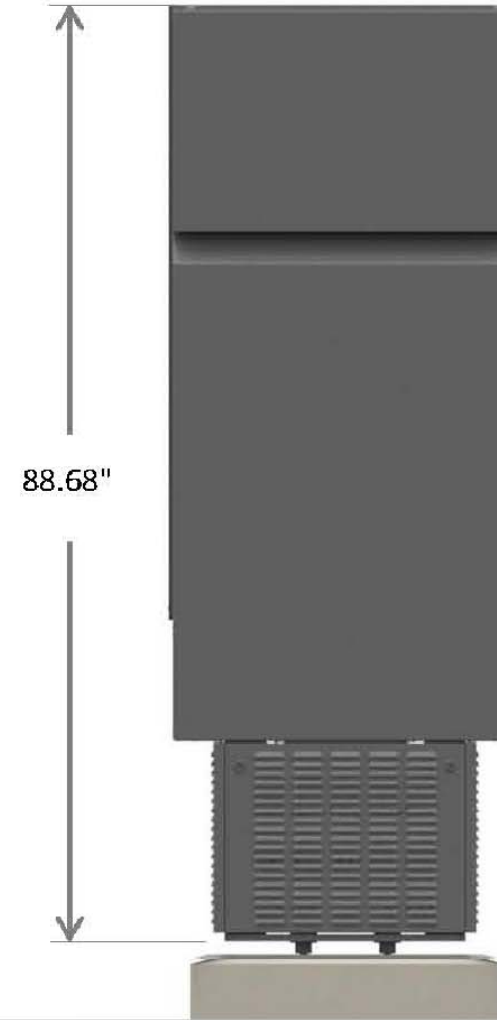
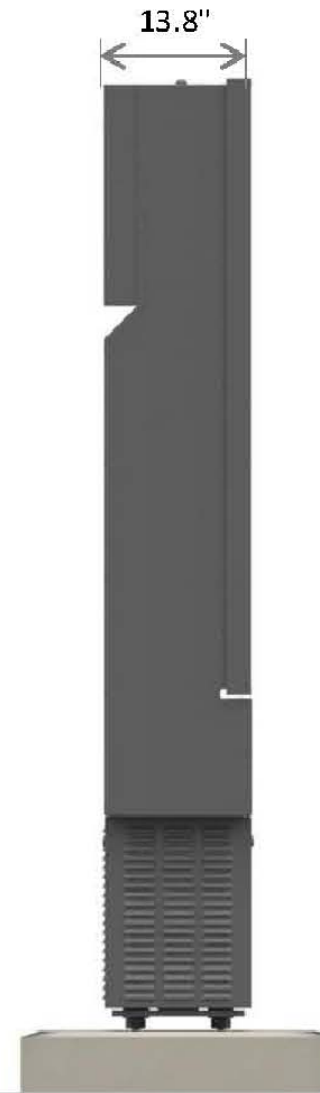
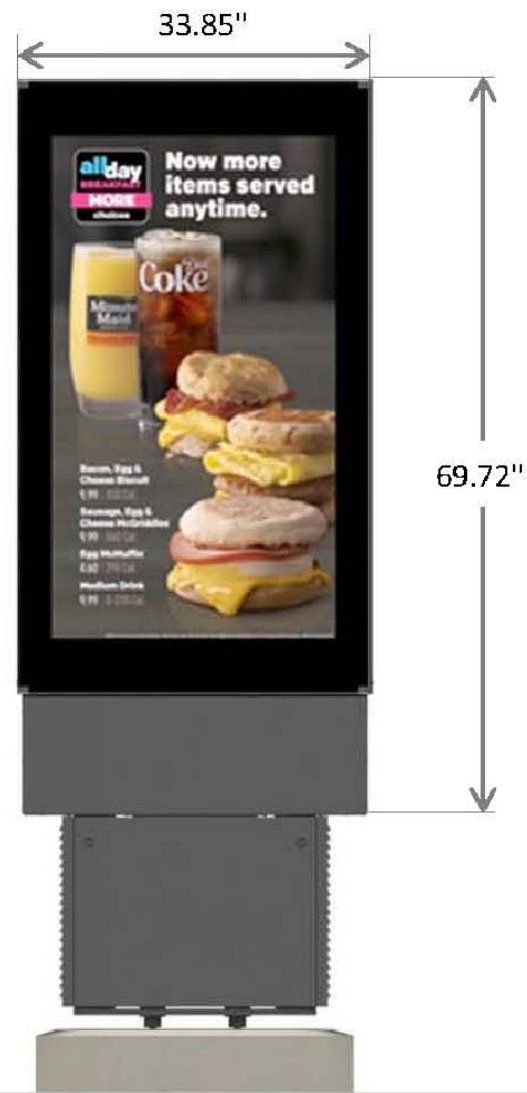

2
SD-201

DIGITAL PRE-BROWSE BOARD
N.T.S.

CHARCOAL

G10 – Double Unit



Main display area

Depth

Total height including base structure

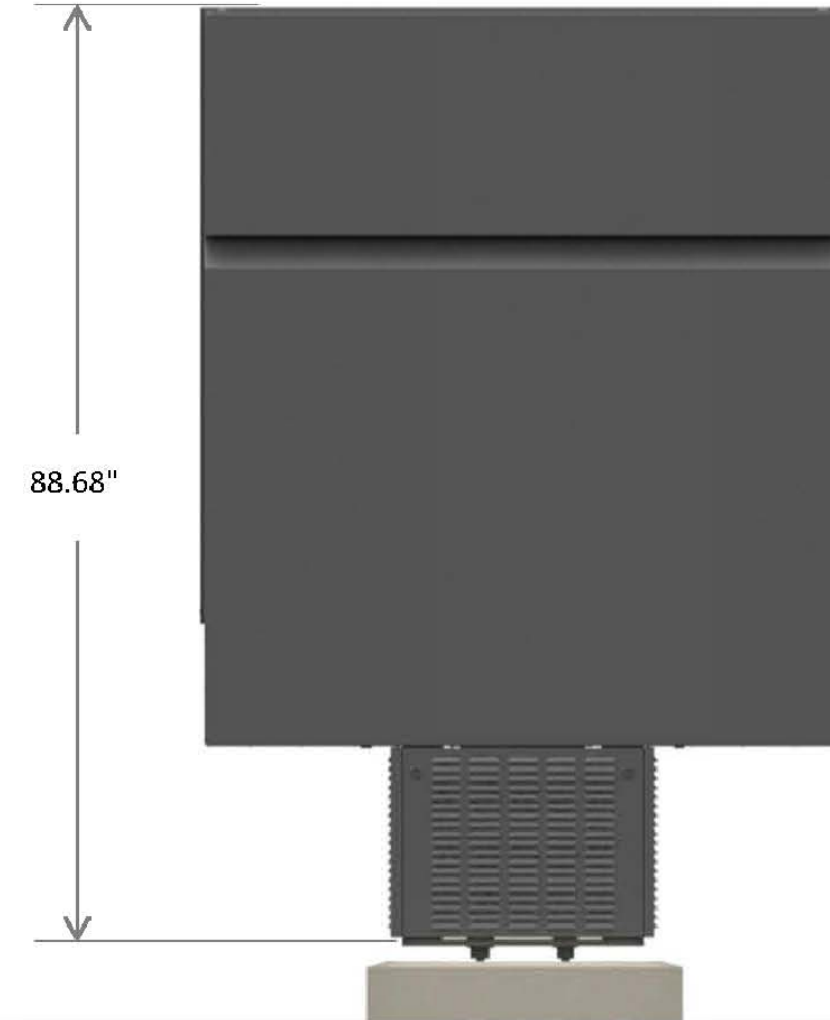
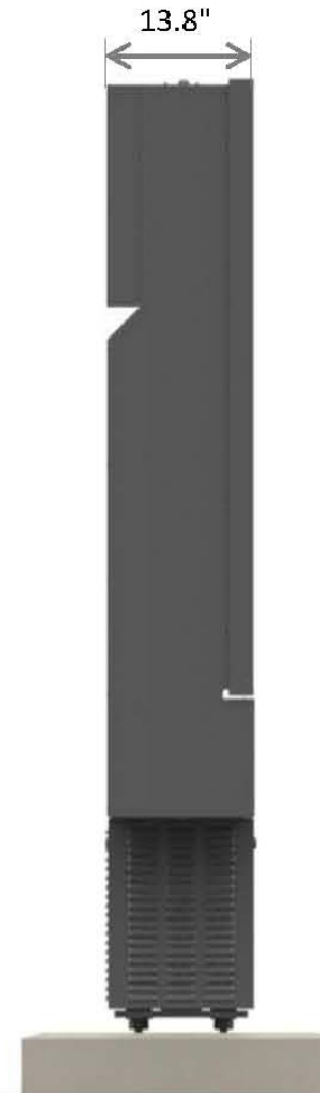

1
SD-201

DIGITAL MENU BOARD
N.T.S.

CHARCOAL